



امداد خودرو فارما

QASHQAI

تلفن شبانه روزی: ۰۲۱-۸۸۸۶۲۰۸۵

OWNER'S MANUAL

FarmaSOS.com

Foreword

Welcome to the growing family of new NISSAN owners. This vehicle has been delivered to you with confidence. It has been produced using the latest techniques and strict quality control.

This manual was prepared to help you understand the operation and maintenance of your vehicle so that you may enjoy many kilometres (miles) of driving pleasure. Please read through this manual before operating your vehicle.

A separate Warranty Information & Maintenance Booklet explains in detail the warranty coverage that applies to your vehicle.

Your NISSAN dealer knows your vehicle best. When you require any service or have any questions, your NISSAN dealer will be glad to assist you with the extensive resources available for you.

IMPORTANT SAFETY INFORMATION

REMINDERS FOR SAFETY!

Follow these important driving rules to help ensure a safe and complete trip for you and your passengers!

- **NEVER** drive under the influence of alcohol or drugs.
- **ALWAYS** observe posted speed limits and never drive too fast for conditions.
- **ALWAYS** use your seat belts and appropriate child restraint systems. Preteen children should be seated in the rear seat.
- **ALWAYS** provide information about the proper use of vehicle safety features to all occupants of the vehicle.
- **ALWAYS** review this Owner's Manual for important safety information.

WHEN READING THE MANUAL

This manual includes information for all options available on this model. Therefore, you may find some information that does not apply to your vehicle.

All information, specifications and illustrations in this manual are those in effect at the time of printing. NISSAN reserves the right to change specifications or designs at any time without notice and without obligation.

MODIFICATION OF YOUR VEHICLE

This vehicle should not be modified. Modifications could affect its performance, safety or durability, and may even violate governmental regulations. In addition, damage or performance problems resulting from modifications may not be covered under NISSAN warranties.

READ FIRST — THEN DRIVE SAFELY

Before driving your vehicle, read this Owner's Manual carefully. This will ensure familiarity with controls and maintenance requirements, assisting you in the safe operation of your vehicle.

Throughout this manual the following symbols and words are used:



WARNING

Indicates the presence of a hazard that could cause death or serious personal injury. To avoid or reduce the risk, the procedures described must be followed precisely.

CAUTION

Indicates the presence of a hazard that could cause minor or moderate personal injury, or damage to your vehicle. To avoid or reduce the risk, the procedures described must be followed carefully.

NOTE

Indicates additional helpful information.



Blue Citizenship

The Blue Citizenship symbol indicates environmentally friendly information and best practices.

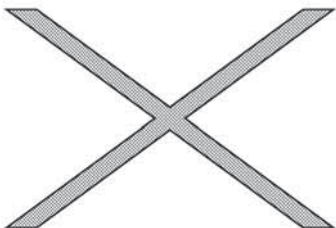

This symbol means “Do not do this” or “Do not let this happen”.



Arrows in an illustration that are similar to these point to the front of the vehicle.



Arrows in an illustration that are similar to these indicate movement or action.



Arrows in an illustration that are similar to these call attention to an item in the illustration.



“NEVER use a rearward facing child restraint on a seat protected by an ACTIVE AIRBAG in front of it, DEATH or SERIOUS INJURY to the CHILD can occur.”

Be sure to read the “Airbag warning labels” description in the Safety section of this manual; and the “Airbag label” description at the end of this manual.

ON-PAVEMENT AND OFF-ROAD DRIVING (4WD models)

This vehicle will handle and manoeuvre differently from an ordinary passenger vehicle, because it has a higher centre of gravity. As with other vehicles with features of this type, failure to operate this vehicle correctly may result in loss of control or an accident.

Be sure to read “On-pavement and off-road driving precautions” and “Four-wheel drive (4WD)” in the “5. Starting and driving” section of this manual.

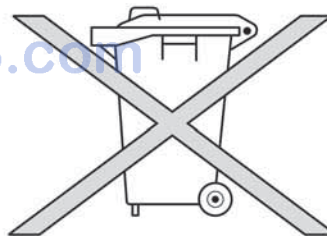

BATTERY DISPOSAL

CAUTION

An improperly disposed battery can harm the environment. Always confirm local regulations for battery disposal.

Examples of the batteries that the vehicle contains:

- Vehicle battery
- Remote controller battery (for Intelligent Key and/or Remote keyless entry system)
- Tyre Pressure Monitoring System (TPMS) sensor battery
- Remote controller battery (for Mobile Entertainment system)

If in doubt, contact your local authority, or a NISSAN dealer, or a qualified workshop for advice on disposal.



Bluetooth® is a trademark owned by Bluetooth SIG, Inc.



iPod® is a trademark of Apple Inc.



Gracenote® and CDDB are registered trademarks of Gracenote, Inc. The Gracenote logo and logo type, and the "Powered by Gracenote" logo are trademarks of Gracenote.

©2013 Nissan International SA, Switzerland

امداد خودرونیاریا
تلفن شبانه روزی: ۰۲۱-۸۸۸۶۲۰۸۵

FarmaSOS.com

Contents

Illustrated table of contents	0
Safety – Seats, Seat belts and Supplemental Restraint System	1
Instruments and controls	2
Pre-driving checks and adjustments	3
Display screen, heater and air conditioner, and audio system	4
Starting and driving	5
In case of emergency	6
Appearance and care	7
Maintenance and do-it-yourself	8
Technical information	9
Index	10

امداد خودرو فارما

تلفن شبانه روزی: ۰۲۱-۸۸۸۶۲۰۸۵

FarmaSOS.com

0 Illustrated table of contents

Seat belts and supplemental restraint system	0-2	Left hand drive.....	0-8
Exterior front	0-3	Right hand drive	0-9
Exterior rear	0-4	Meters and gauges	0-10
Passenger compartment	0-5	Engine compartment.....	0-11
Cockpit	0-6	HRA2DDT engine.....	0-12
Left hand drive.....	0-6	MR20DD engine.....	0-12
Right hand drive	0-7	K9K engine.....	0-13
Instrument and control layout	0-8	R9M engine.....	0-14

تلفن شبانه روزی: ۰۲۱-۸۸۸۶۲۰۸۵

FarmaSOS.com

SEAT BELTS AND SUPPLEMENTAL RESTRAINT SYSTEM

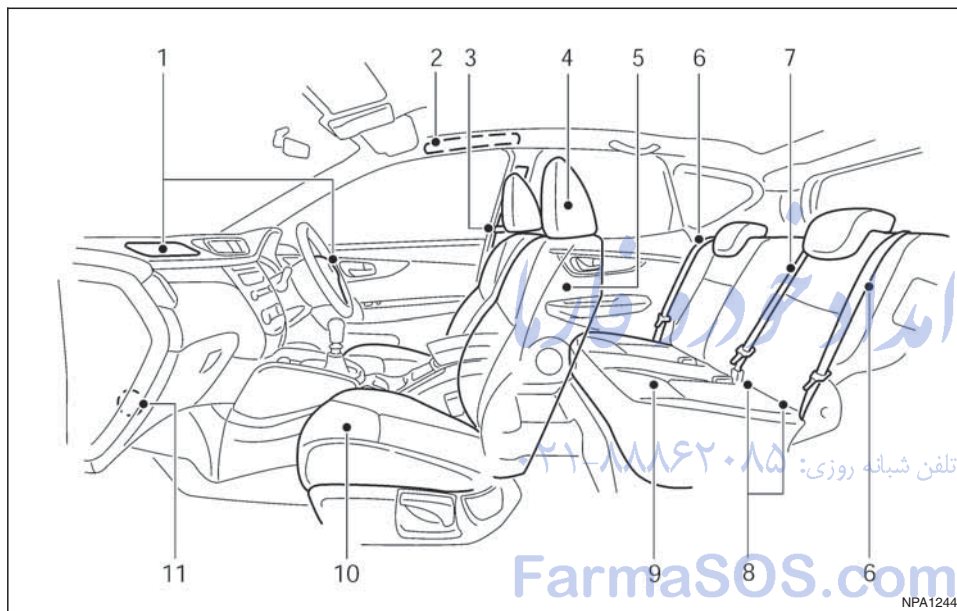

11. Front passenger air bag switch* (P. 1-35)

* where fitted

- | | |
|--|--|
| 1. Supplemental front-impact air bags (P. 1-29) | 6. Rear outboard seat belts (P. 1-8) |
| 2. Supplemental curtain side-impact air bags (P. 1-29) | 7. Rear centre seat belt (P. 1-8) |
| 3. Front seat belts (P. 1-8) | 8. ISOFIX child restraint system (P. 1-21) |
| 4. Head restraints (P. 1-6) | 9. Rear seats (P. 1-5)
— Child restraints (P. 1-15) |
| 5. Supplemental side-impact air bags (P. 1-29) | 10. Front seats (P. 1-3) |

EXTERIOR FRONT

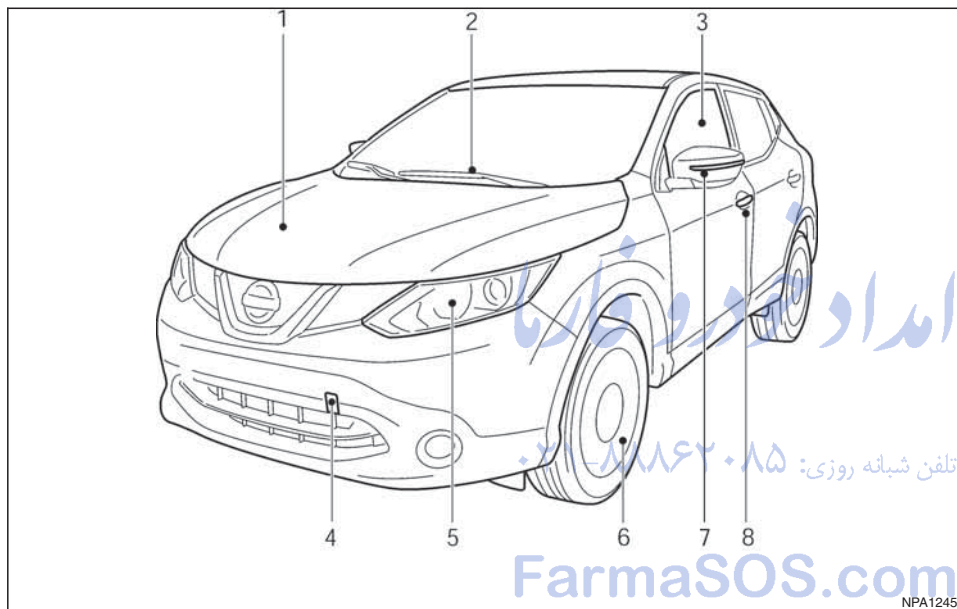

1. Bonnet (P. 3-14)
2. Windscreen wipers and washers
 - Switch operation (P. 2-32)
 - Blade replacement (P. 8-24)
 - Window washer fluid (P. 8-15)
 - Windscreen deicer (P. 2-35)
 - ThermoClear* (P. 2-34)
3. Power windows (P. 2-48)
4. Towing eye (P. 6-16)
5. Headlights, front side lights, turn signal lights (Switch P. 2-36, Location and bulb replacement P. 8-27)
6. Tyres (Tyres and wheels P. 8-33, P. 9-5, Flat tyre P. 6-3), Tyre Pressure Monitoring System (TPMS) P. 6-4)

7. Outside rear-view mirrors (P. 3-19)
Side turn signal light (P. 2-36, Location and bulb replacement P. 8-27)
 8. Doors (Keys P. 3-2, Door locks P. 3-8, Remote keyless entry system P. 3-4)
- * where fitted

EXTERIOR REAR

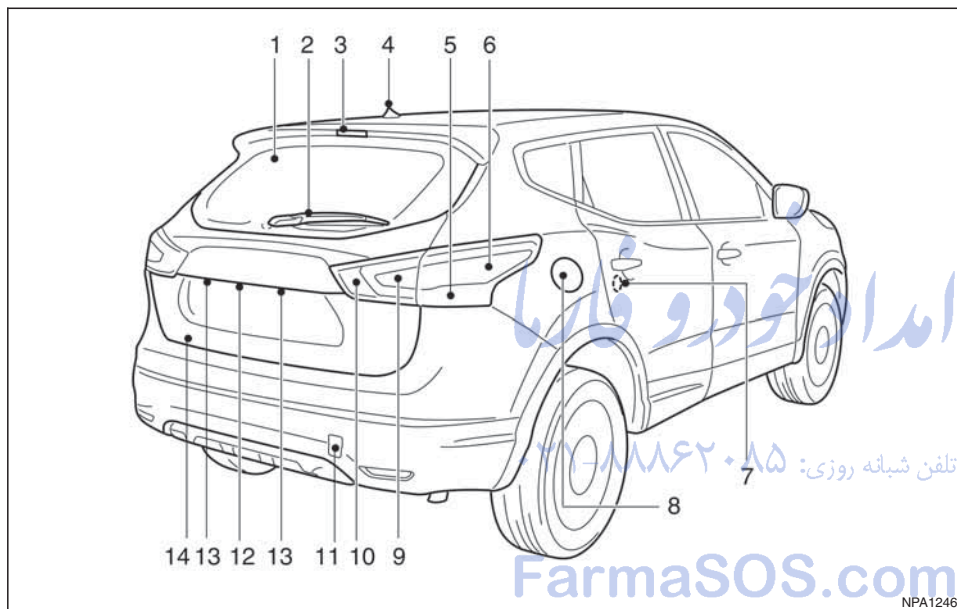

1. Rear window (Defogger switch, P. 2-35)
2. Rear wiper and washer
 - Wiper and washer switch (P. 2-32)
 - Wiper replacement (P. 8-24)
 - Washer fluid (P. 8-15)
3. High-mounted stop light (P. 8-27)
4. Antenna (P. 8-23).

5. Tail light and brake light
 - Switch location (P. 2-36)
 - Bulb replacement (P. 8-27)
6. Rear turn signal light
 - Switch location (P. 2-36)
 - Bulb replacement (P. 8-27)
7. Doors
 - Keys (P. 3-2)

- Door locks (P. 3-8)
 - Child safety lock (P. 8-11)
8. Fuel filler cap (P. 3-15)
 9. Reversing light (P. 8-27)
 10. Rear fog light* (P. 8-27)
 11. Towing eye (P. 6-16)
 12. Rear view camera*
 - Rear-View Monitor* (P. 4-2)
 - Around View Monitor* (P. 4-4)
 13. Number plate lights (P. 8-27)
 14. Back door
 - Door locks (P. 3-11)
 - Remote keyless entry system (P. 3-4)
- * where fitted

PASSENGER COMPARTMENT

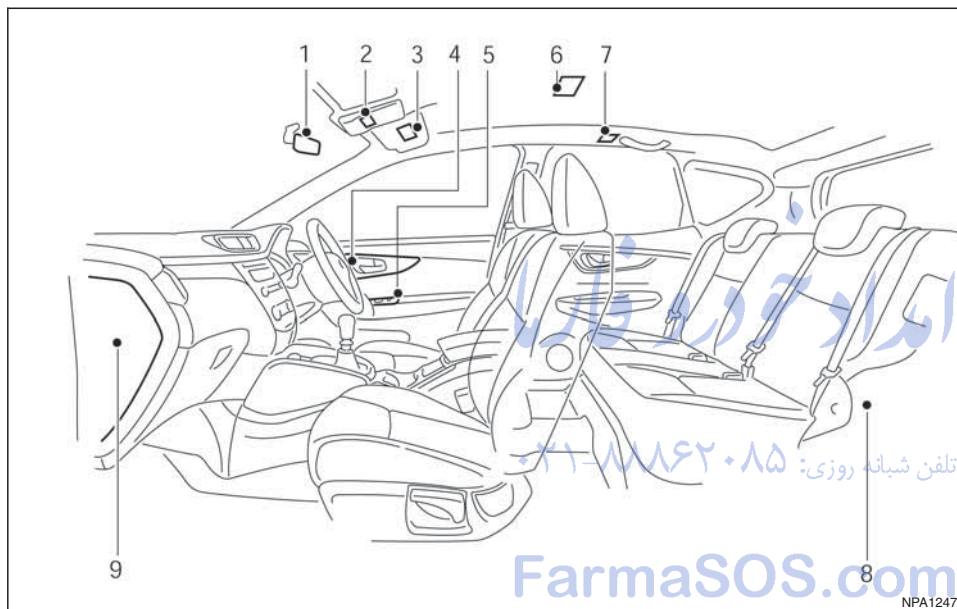

- Parcel shelf (P. 2-45)
- Luggage floor (P. 2-47)
- Luggage hooks (P. 2-47)

9. Fuse box (P. 8-25)

* where fitted

1. Inside rear-view mirror (P. 2-18)
2. Map light (P. 2-50)
3. Sun visors (P. 2-50)
4. Inside door handle (P. 2-18)
 - Outside mirror folding switch* (P. 3-20)
 - Outside mirror remote control (P. 3-19)
5. Door armrest
6. Interior (room) light (models without fixed glass roof)* (P. 2-51)
7. Interior (reading) light (models with fixed glass roof)* (P. 2-51)
8. Luggage (boot) compartment

— Power windows controls (P. 2-48)

— Power door lock switch (P. 2-10)

COCKPIT

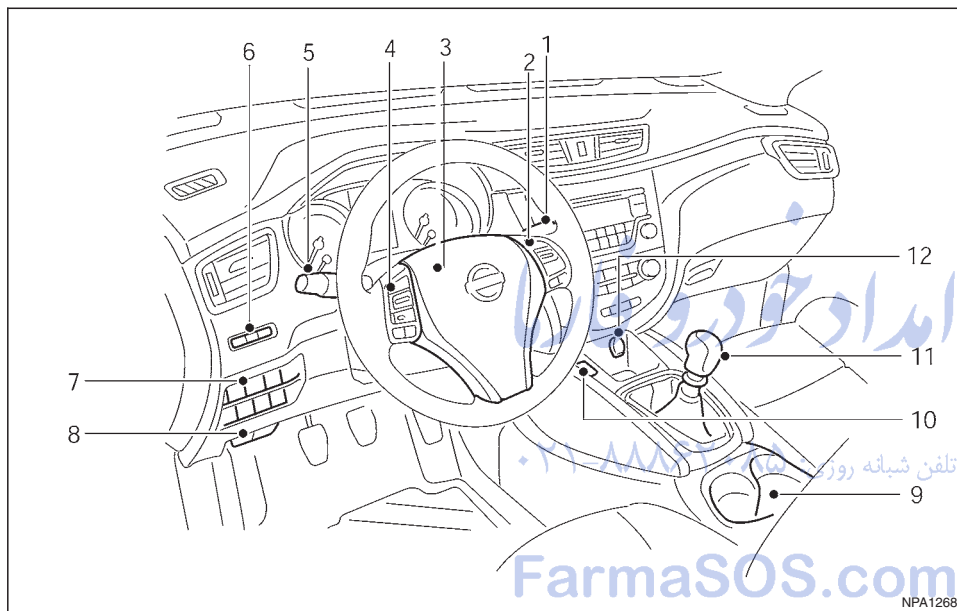

LEFT HAND DRIVE

1. Wiper and washer switch (P. 2-32)
2. Steering wheel switches
 - Cruise control* (P. 5-36)
 - Speed limiter* (P. 5-38)
 - Mobile phone integration for FM-AM radio with CD player without navigation (P. 4-39)
3. Steering wheel
 - Mobile phone integration for NissanConnect* *1
 - Electric power steering system (P. 5-57)
 - Horn (P. 2-41)
 - Driver's supplemental front-impact air bag (P. 1-29)
4. Steering wheel switches

- Vehicle information display switches (P. 2-13)
 - Audio switches* (P. 4-38)
5. Headlight and turn signal switch (P. 2-36)
 6. TRIP/RESET/brightness switches
 - Instrument brightness switch (P. 2-3)
 - TRIP/RESET switch for twin trip odometer (P. 2-2)
 7. Switch panel
 - Electronic Stability Programme (ESP) OFF switch* (P. 5-60)
 - ECO mode switch* (P. 5-65)
 - Stop/Start System OFF switch* (P. 5-22)
 - Ultrasonic Parking Sensor switch* (P. 5-45)
 - Headlight aiming control switch* (P. 2-39)
 - 2WD/4WD switch* (P. 5-26)
 - Headlight cleaner switch* (P. 2-40)
 8. — Fuel filler lid release handle (P. 3-15)
— Bonnet release handle (P. 3-14)
 9. Front cup holders (P. 2-44)
 10. Electric parking brake (P. 3-16)
 11. Shift lever (P. 5-17)
 12. Power outlet (P. 2-42)
- * where fitted
- *1 Refer to the separately provided NissanConnect Owner's Manual.

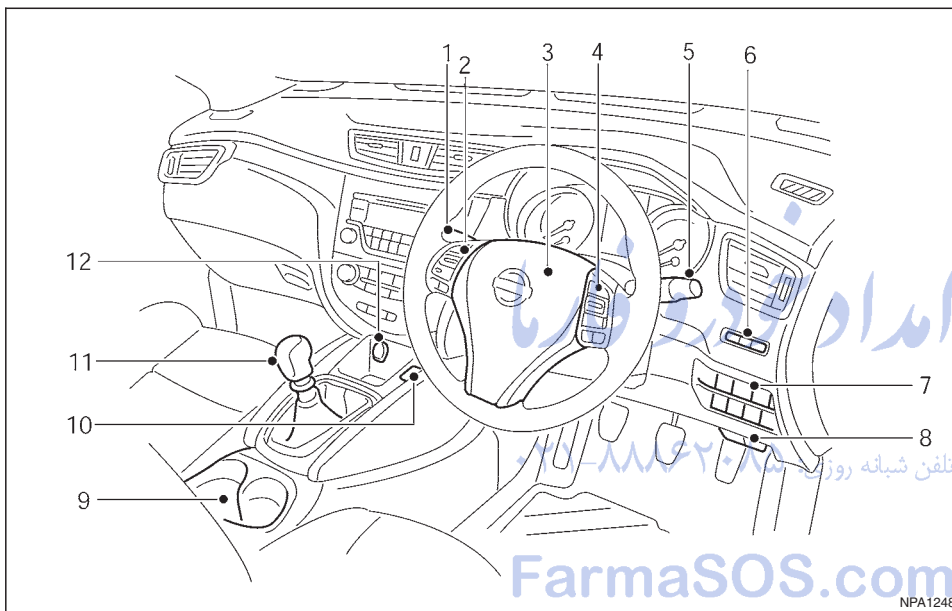

RIGHT HAND DRIVE

1. Headlight and turn signal switch (P. 2-36)
2. Steering wheel switches
 - Vehicle information display switches (P. 2-13)
 - Audio switches* (P. 4-38)
3. Steering wheel

- Electric power steering system (P. 5-57)
 - Horn (P. 2-41)
 - Driver's supplemental front-impact air bag (P. 1-29)
4. Steering wheel switches
 - Cruise control* (P. 5-36)
 - Speed limiter* (P. 5-38)
 - Mobile phone integration for FM-AM radio

with CD player without navigation* (P. 4-39)
 – Mobile phone integration for NissanConnect* *1

5. Wiper and washer switch (P. 2-32)
6. TRIP/RESET/brightness switches
 - Instrument brightness switch (P. 2-3)
 - TRIP/RESET switch for twin trip odometer (P. 2-2)
7. Switch panel
 - Electronic Stability Programme (ESP) OFF switch* (P. 5-60)
 - ECO mode switch* (P. 5-65)
 - Stop/Start System OFF switch* (P. 5-22)
 - Ultrasonic Parking Sensor switch* (P. 5-45)
 - Headlight aiming control switch* (P. 2-39)
 - 2WD/4WD switch (P. 5-26)
8. – Fuel filler lid release handle (P. 3-15)
 – Bonnet release handle (P. 3-14)
9. Front cup holders (P. 2-44)
10. Electric parking brake (P. 3-16)
11. Shift lever (P. 5-17)
12. Power outlet (P. 2-42)

* where fitted

*1 Refer to the separately provided NissanConnect Owner's Manual.

INSTRUMENT AND CONTROL LAYOUT

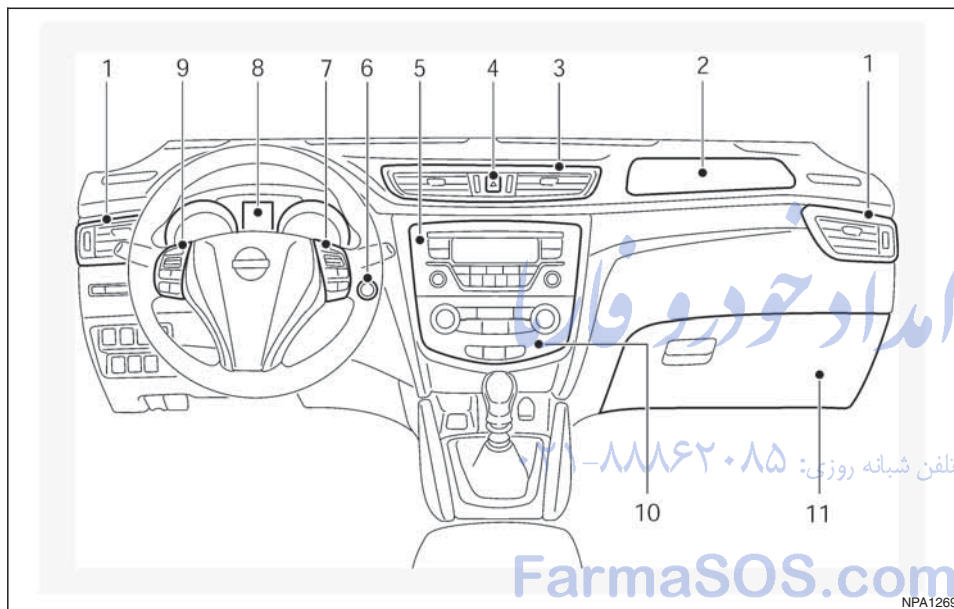

- Speed limiter* (P. 5-38)
- Mobile phone integration for FM-AM radio with CD player without navigation* (P. 4-39)
- Mobile phone integration for NissanConnect* *¹(P. 4-38)

8. Meters, gauges, warning/indicator lights, vehicle information display (P. 2-2, P. 2-4, P. 2-13)
9. Steering wheel switches
 - Vehicle information display switches (P. 2-13)
 - Audio control* (P. 4-38)
10. Heater and air conditioner (P. 4-15)
11. Glove box (P. 2-42)

* where fitted

*¹ Refer to the separately provided NissanConnect Owner's Manual.

LEFT HAND DRIVE

1. Left and right side vents (P. 4-14)
2. Front passenger's supplemental front-impact air bag (P. 1-30)
3. Centre vents (P. 4-14)
4. Hazard warning flasher switch (P. 6-2)
5. Audio system* (P. 4-23)
 - NissanConnect* *¹(P. 4-38)
 - without navigation* (P. 4-24)
6. Ignition switch (behind steering wheel) (P. 5-11)
 - Push Button ignition switch* (P. 5-12)
7. Steering wheel switches
 - Cruise control* (P. 5-36)

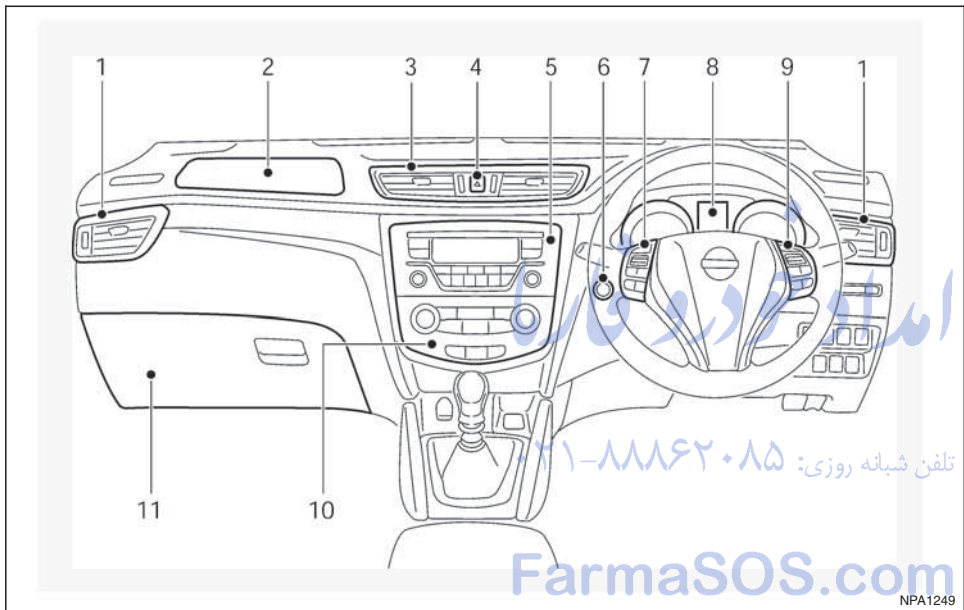

(P. 2-13)

— Audio control* (P. 4-38)

8. Meters, gauges, warning/indicator lights, vehicle information display (P. 2-2, P. 2-4, P. 2-13)

9. Steering wheel switches*
 — Cruise control* (P. 5-36)
 — Speed limiter* (P. 5-38)
 — Mobile phone integration for FM-AM radio with CD player without navigation* (P. 4-39)
 — Mobile phone integration for NissanConnect**^{*1}(P. 4-38)

10. Heater and air conditioner (P. 4-15)

11. Glove box (P. 2-42)

* where fitted

^{*1} Refer to the separately provided NissanConnect Owner's Manual.

RIGHT HAND DRIVE

1. Left and right side vents (P. 4-14)
2. Front passenger's supplemental front-impact air bag (P. 1-30)
3. Centre vents (P. 4-14)
4. Hazard warning flasher switch (P. 6-2)

5. Audio system* (P. 4-23)
 — NissanConnect**^{*1}(P. 4-38)
 — without navigation* (P. 4-24)
6. Ignition switch (behind steering wheel) (P. 5-11)
 — Push Button ignition switch* (P. 5-12)
7. Steering wheel switches
 — Vehicle information display switches

METERS AND GAUGES

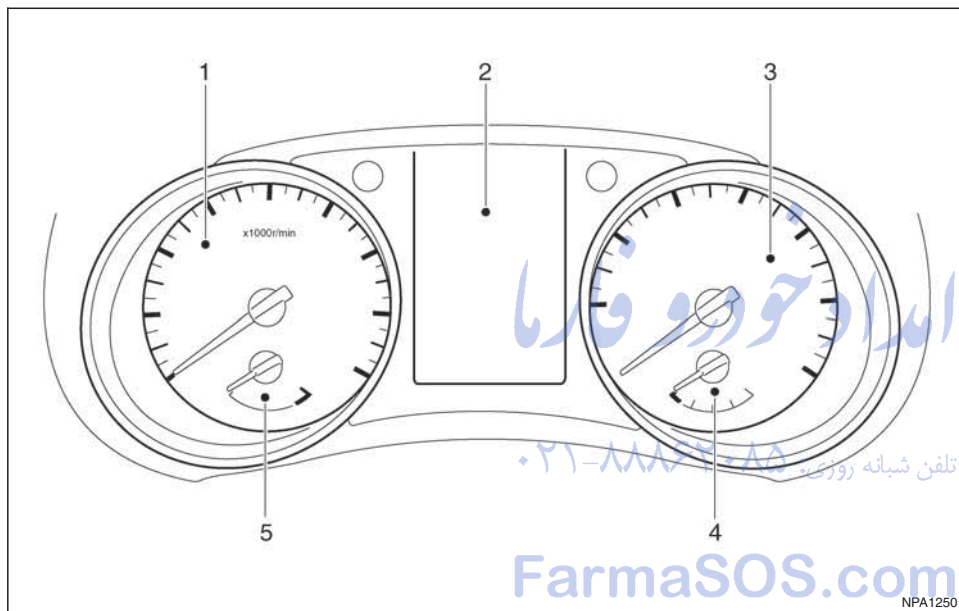

1. Tachometer (P. 2-2),
– Warning/indicator lights (P. 2-4)
2. Vehicle information display (P. 2-13)
3. Speedometer (P. 2-2)
– Warning/indicator lights (P. 2-4)
4. Fuel gauge (P. 2-2)
5. Engine coolant temperature gauge (P. 2-3)

ENGINE COMPARTMENT

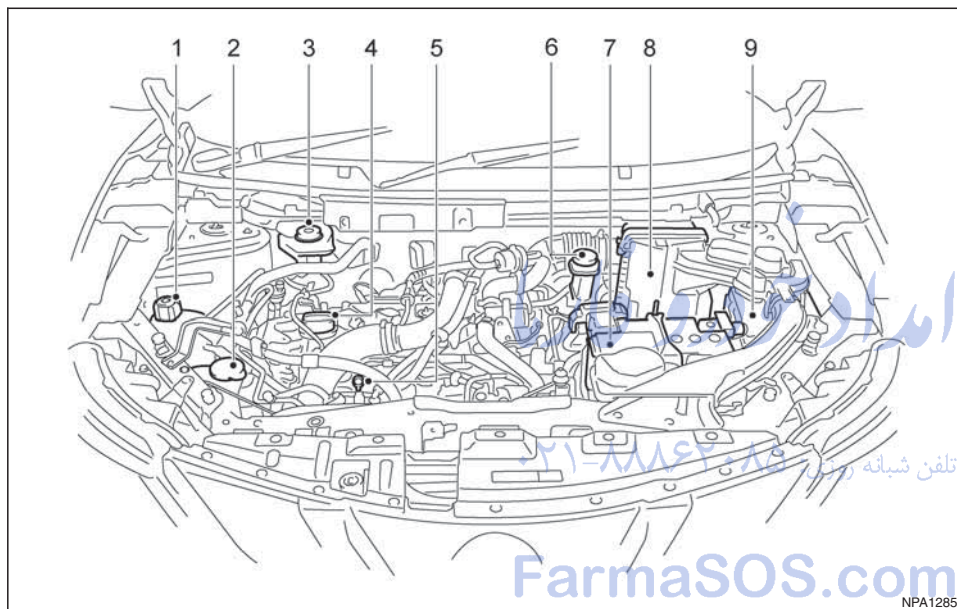

HRA2DDT ENGINE

1. Engine coolant reservoir (P. 8-6)
2. Window washer/headlight cleaner (where fitted) fluid reservoir (P. 8-15)
3. Brake/clutch fluid reservoir (MT (RHD) models), Brake fluid reservoir (XTRONIC transmission (RHD) models) (P. 8-14)
4. Engine oil filler cap (P. 8-8)
5. Engine oil dipstick (P. 8-8)
6. Brake/clutch fluid reservoir (MT (LHD) models), Brake fluid reservoir (XTRONIC transmission (LHD) models) (P. 8-14)
7. Battery (P. 8-16)
8. Air cleaner filter (P. 8-23)
9. Fuses/fusable link box (P. 8-25)

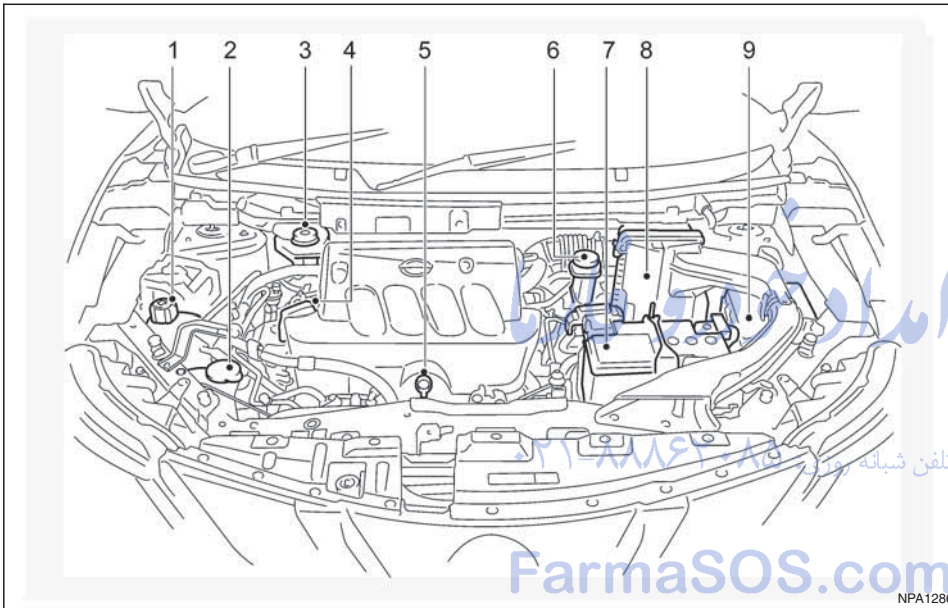

MR20DD ENGINE

1. Engine coolant reservoir (P. 8-6)
2. Window washer/headlight cleaner (where fitted) fluid reservoir (P. 8-15)
3. Brake/clutch fluid reservoir (MT (RHD) models), Brake fluid reservoir (XTRONIC transmission (RHD) models) (P. 8-14)
4. Engine oil filler cap (P. 8-8)
5. Engine oil dipstick (P. 8-8)
6. Brake/clutch fluid reservoir (MT (LHD) models), Brake fluid reservoir (XTRONIC transmission (LHD) models) (P. 8-14)
7. Battery (P. 8-16)
8. Air cleaner filter (P. 8-23)
9. Fuses/fusible link box (P. 8-25)

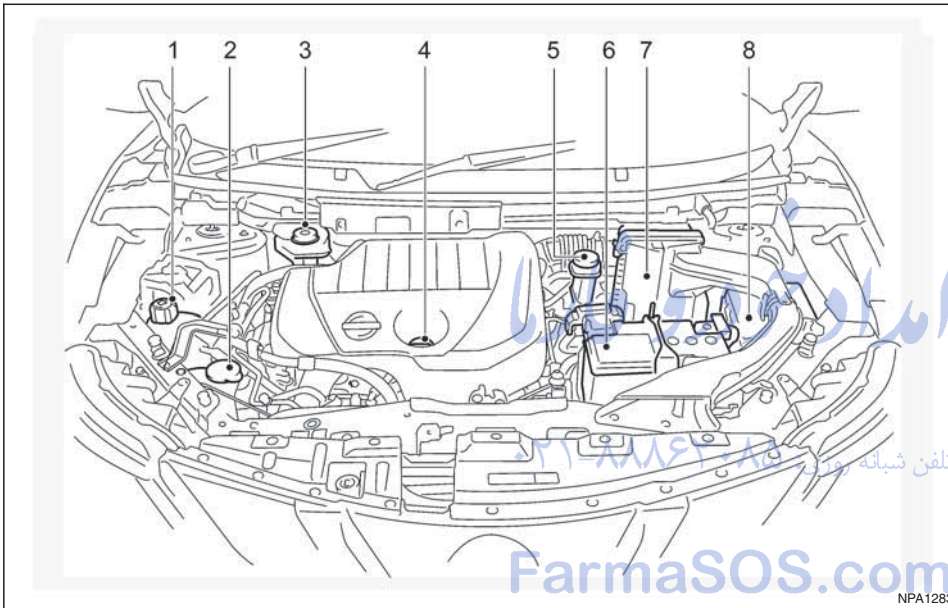

K9K ENGINE

1. Engine coolant reservoir (P. 8-6)
2. Window washer/headlight cleaner (where fitted) fluid reservoir (P. 8-15)
3. Brake/clutch fluid reservoir (MT (RHD) models), (P. 8-14)
4. Engine oil filler cap (P. 8-8)
Engine oil dipstick (P. 8-8)
5. Brake/clutch fluid reservoir (MT (LHD) models), (P. 8-14)
6. Battery (P. 8-16)
7. Air cleaner filter (P. 8-23)
8. Fuses/fusible link box (P. 8-25)

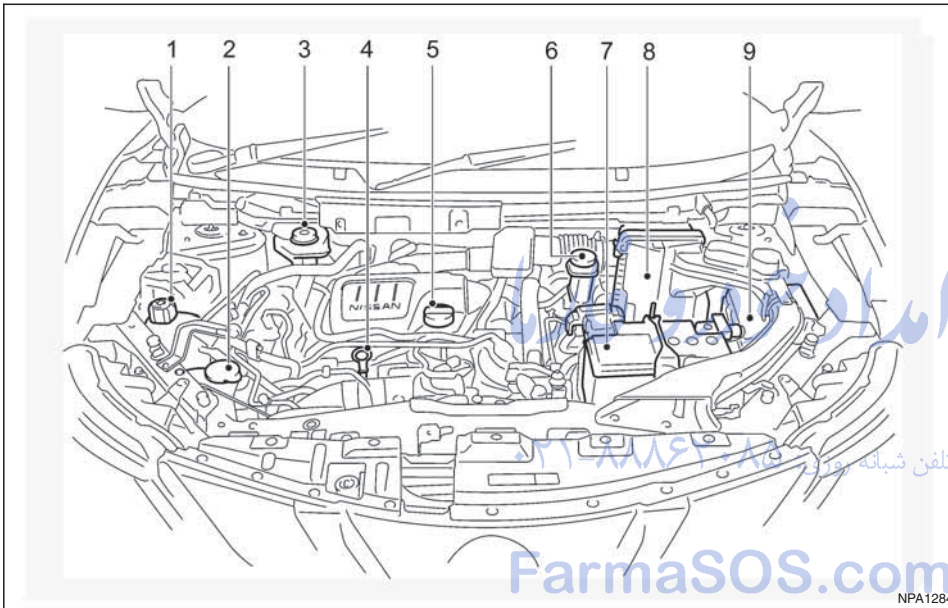

R9M ENGINE

1. Engine coolant reservoir (P. 8-6)
2. Window washer/headlight cleaner (where fitted) fluid reservoir (P. 8-15)
3. Brake/clutch fluid reservoir (MT (RHD) models), Brake fluid reservoir (XTRONIC transmission (RHD) models) (P. 8-14)
4. Engine oil dipstick (P. 8-8)
5. Engine oil filler cap (P. 8-8)
6. Brake/clutch fluid reservoir (MT (LHD) models), Brake fluid reservoir (XTRONIC transmission (LHD) models) (P. 8-14)
7. Battery (P. 8-16)
8. Air cleaner filter (P. 8-23)
9. Fuses/fusible link box (P. 8-25)

1 Safety — seats, seat belts and supplemental restraint system

Seats.....	1-2	Pre-tensioner seat belt system	1-13
Front seats	1-3	Child safety	1-14
Seat heater (where fitted)	1-4	Infants	1-14
Rear seats	1-5	Small children	1-14
Armrests (where fitted)	1-5	Larger children	1-15
Head restraints	1-6	Legal requirements	1-15
Adjustable head restraint components.....	1-6	Child restraints	1-15
Non-adjustable head restraint components.....	1-6	Precautions on child restraints	1-15
Remove	1-7	Child restraint and ISOFIX information.....	1-16
Install.....	1-7	ISOFIX child restraint system.....	1-21
Adjust.....	1-7	Child restraint anchorage.....	1-22
Seat belts	1-8	Child restraint installation using ISOFIX	1-23
Precautions on seat belt usage	1-8	Child restraint installation using three-point type seat belt	1-25
Child safety	1-9	Supplemental Restraint System (SRS)	1-29
Pregnant women	1-10	Precautions on Supplemental Restraint System (SRS).....	1-29
Injured persons.....	1-10	Supplemental air bag systems	1-33
Seat belt warnings	1-10	Repair and replacement procedure	1-37
Three-point type seat belt.....	1-11		
Seat belt maintenance	1-12		

SEATS

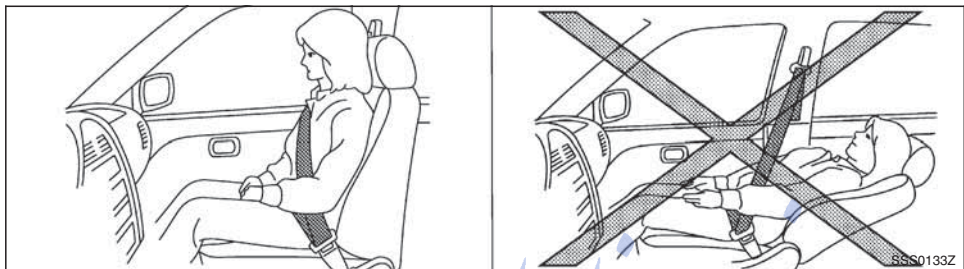

Sit upright and well back



WARNING

- Do not ride in a moving vehicle when the seatback is reclined. This can be dangerous. The shoulder belt will not be against your body. In an accident, you could be thrown into it and receive neck or other serious injuries. You could also slide under the lap belt and receive serious internal injuries.
- For the most effective protection when the vehicle is in motion, the seat should be upright. Always sit well back in the seat with both feet on the floor and adjust the seat properly. See “Precautions on seat belt usage” later in this section.
- Do not adjust the driver’s seat while driving. The seat may move suddenly and could cause loss of control of the vehicle.
- After adjustment, gently rock in the seat to make sure it is securely locked.

- The seatback should not be reclined any more than needed for comfort. Seat belts are most effective when the passenger sits well back and upright in the seat. If the seatback is reclined, the risk of sliding under the lap belt and being injured is increased.
- When returning the seatbacks to the upright position, be certain that they are completely secured in the latched position. If they are not completely secured, passengers may be injured in an accident or sudden stop. When operating the seatback release always rock the seatback afterward to check that it is locked.
- When the vehicle is being used to carry cargo, properly secure all cargo to help prevent it from sliding or shifting. Do not place cargo higher than the seatbacks. In a sudden stop or collision, unsecured cargo could cause personal injury.

- Never allow anyone to ride in the luggage area or on the rear seat when it is in the folded-down position. Use of these areas by passengers without proper restraints could result in serious injury in an accident or sudden stop.

CAUTION

When adjusting the seat positions, be sure not to contact any moving parts to avoid possible injuries and/or damage.

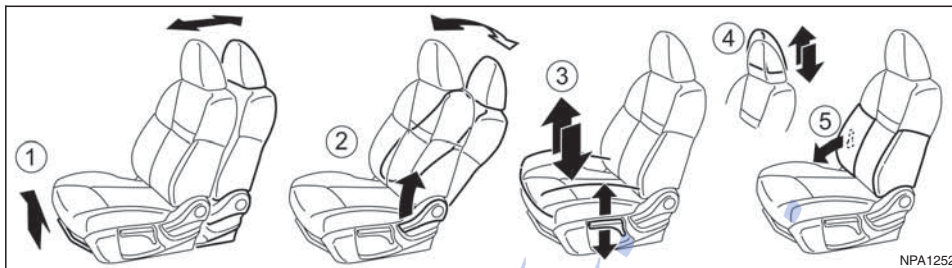

FRONT SEATS

Manual seat adjustment

Forward and backward:

Pull the lever ① up and hold it while sliding the seat forward or backward to the preferred position. Release the lever to lock the seat in position.

Reclining:

To recline the seatback pull and hold the lever ② up, keeping the lever fully lifted, and lean back. To bring the seatback forward pull and hold the lever up, keeping the lever fully lifted, and lean forward. Keep the lever fully lifted whilst adjusting the seatback. Release the lever when the seatback is stationary and in the desired recline position.

The reclining feature allows adjustment of the seatback for occupants of different sizes for added comfort and to help obtain proper seat belt fit, see “Precautions on seat belt usage” later in this section. Also, the seatback can be reclined to allow occu-

pants to rest when the vehicle is stopped and the vehicle is in the P (Park) position or N (Neutral) position with the parking brake applied.

Seat lifter (where fitted):

Repeatedly pull up or push down the adjusting lever ③, to adjust the seat height to the desired position.

Head restraints:

Push and hold the lock knob ④ to remove, install, or (where possible) adjust the head restraints. For proper adjustment see “Head restraints” later in this section.

Lumbar support (where fitted):

The lumbar support feature provides lower back support to the driver. Move the adjusting lever ⑤ forward or backward to adjust the seat lumbar area until the desired position is achieved.

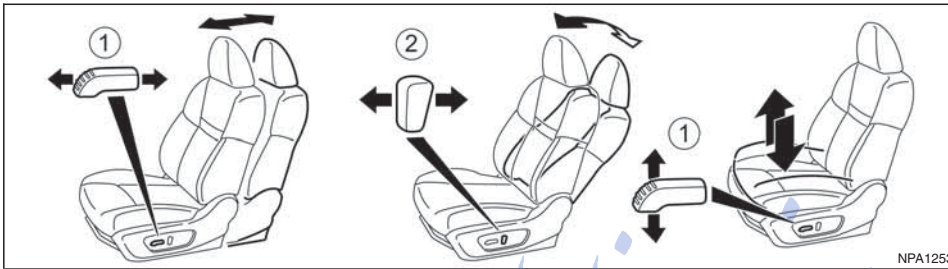

Power seat adjustment (where fitted)



WARNING

Never leave children or adults who would normally require the support of others alone in the vehicle. Pets should not be left alone either. They could unknowingly activate switches or controls and inadvertently become involved in a serious accident and injure themselves.

Operating tips:

- The power seat motor has an auto-reset overload protection circuit. If the motor stops during the seat adjustment, wait 30 seconds, then reactivate the switch.
- To avoid discharge of the battery, do not operate the power seats for a long period of time when the engine is not running.

Forward and backward:

Move the adjusting switch ① forward or backward to the desired position.

Reclining:

Move the adjusting switch ② forward or backward to the desired position.

The reclining feature allows the adjustment of the seatback for occupants of different sizes to help obtain the proper seat belt fit. (See "Precautions on seat belt usage" later in this section.)

The seatback may be reclined to allow occupants to rest when the vehicle is parked.

Seat lifter (where fitted):

Pull the adjusting switch ① up or push down to adjust the seat height until the desired position is achieved.

SEAT HEATER (where fitted)

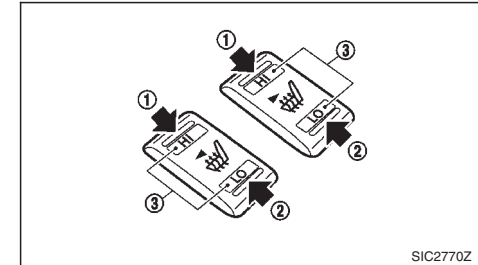

CAUTION

- With the ignition switch in the ON position, the battery could run down if the seat heater is operated while the engine is not running.
- Avoid using the seat heater for any longer than is necessary, or when the seat is not occupied.
- Do not put anything on the seat which insulates heat, such as a blanket, cushion, seat cover, etc. Otherwise, the seat may become overheated.
- Do not place anything hard or heavy on the seat or pierce it with a pin or similar object. This may result in damage to the seat heater.
- Any liquid spilled on the seat should be removed immediately with a dry cloth.
- When cleaning the seat, never use petrol, thinner, or any similar materials.

- If any malfunctions are found or the seat does not operate, turn the switch off and have the system checked by a NISSAN dealer or qualified workshop.

Heated seats

The seats can be warmed by built-in heaters. The switches are located on the centre console (for front seats) and can be operated independently of each other.

1. Start the engine.
2. Select heat range.
 - For high heat, push the "HI" (High) side of the switch ①.
 - For low heat, push the "LO" (Low) side of the switch ②.
 - The indicator light ③ will illuminate when low or high is selected.
3. To turn off the heater push the "HI" or "LO" side to return the switch to the level position.

Make sure the indicator light turns off.

The heater is controlled by a thermostat, automatically turning the heater on and off. The indicator light will remain on as long as the switch is on.

When the vehicle's interior is warmed, or before you leave the vehicle, be sure to turn off the switch.

REAR SEATS

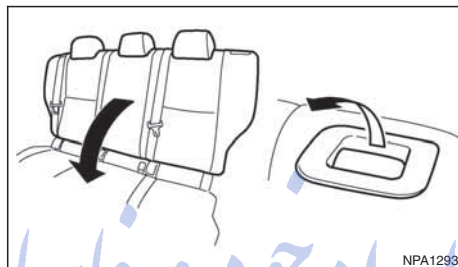

Folding

The luggage compartment loading capacity can be increased by folding the rear seats forward.

To fold the seat:

1. Ensure head restraints are properly stowed, see "Head restraints" later in this section.
2. Release the seatback lock by pressing the latch.
3. Fold the seat forward.

To return the seat to an upright position:

1. Make sure the seat belts are clear of the seat latch mechanism.
2. Lift the seatback up and push firmly to lock.
3. If the red marker is visible then the seat has not latched properly — release and then re-latch the seat.

CAUTION

Always ensure that the seat belt is not trapped in the release lever or any other vehicle part.

ARMRESTS (where fitted)

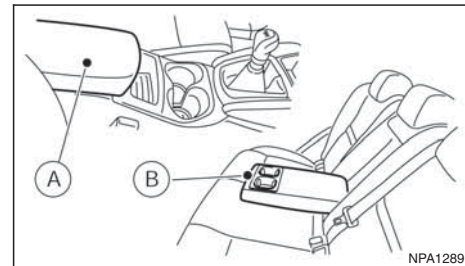

1. Front armrest (A)

The console box lid can be used as an armrest.

2. Rear armrest (B)

On the rear seat, pull the top of the armrest and lay it horizontally.

HEAD RESTRAINTS



WARNING

Head restraints supplement the other vehicle safety systems. They may provide additional protection against injury in certain rear end collisions. Adjust the head restraints properly, as specified in this section. Check the adjustment after someone else uses the seat. Do not attach anything to the head restraint stalks or remove the head restraint. Do not use the seat if the head restraint has been removed. If the head restraint was removed, reinstall and properly adjust the head restraint before an occupant uses the seating position. Failure to follow these instructions can reduce the effectiveness of the head restraints. This may increase the risk of serious injury or death in a collision.

- Your vehicle is equipped with head restraints. On the front seats they are adjustable. On the rear seats, where fitted, they are non-adjustable but have a lower storage position.
- Adjustable head restraints have multiple notches along the stalk to lock them in a desired adjustment position.
- The non-adjustable head restraints have a single locking notch to secure them to the seat frame.
- Proper Adjustment:
 - For the adjustable type, align the head restraint so the centre of your ear is approximately level with the centre of the head restraint.

- If your ear position is still higher than the recommended alignment, place the head restraint at the highest position.
- For the non-adjustable type, raise into locking position before use. The seat should not be occupied with the head restraint in the lower storage position.
- If the head restraint has been removed, ensure that it is reinstalled and locked in place before riding in that designated seating position.

ADJUSTABLE HEAD RESTRAINT COMPONENTS

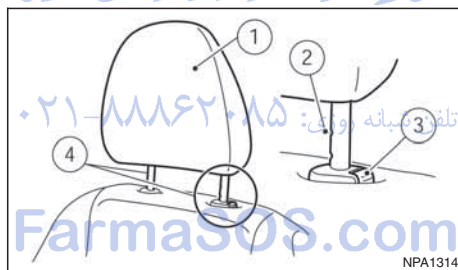

1. Removable head restraint
2. Multiple notches
3. Lock knob
4. Stalks

NON-ADJUSTABLE HEAD RESTRAINT COMPONENTS

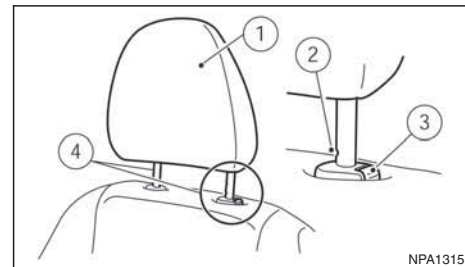

1. Removable head restraint
2. Single notch
3. Lock knob
4. Stalks

REMOVE

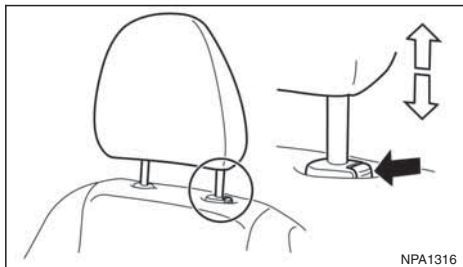

Use the following procedure to remove the head restraint.

1. Pull the head restraint up to the highest position.
2. Push and hold the lock knob.
3. Remove the head restraint from the seat.
4. Store the head restraint properly in a secure place so it is not loose in the vehicle.
5. Reinstall and properly adjust the head restraint before an occupant uses the seating position.

INSTALL



1. Align the head restraint stalks with the holes in the seat. Make sure that the head restraint is facing the correct direction. The stalk with the adjustment notch ① must be installed in the hole with the lock knob ②.
2. Push and hold the lock knob and push the head restraint down.
3. Properly adjust the head restraint before an occupant uses the seating position.

ADJUST

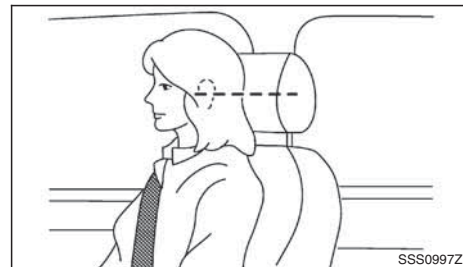

For adjustable front head restraint

Adjust the head restraint so the centre is level with the centre of your ears. If your ear position is still higher than the recommended alignment, place the head restraint at the highest position.

For non-adjustable head restraint

Make sure the head restraint is positioned so the lock knob is engaged in the notch before riding in that designated seating position.

SEAT BELTS

Raise

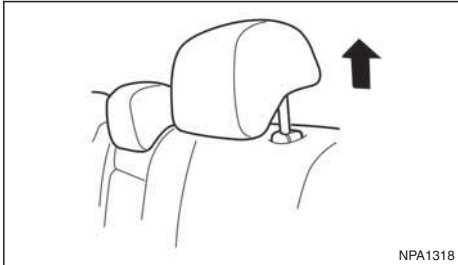

To raise the head restraint, pull it up.

Lower

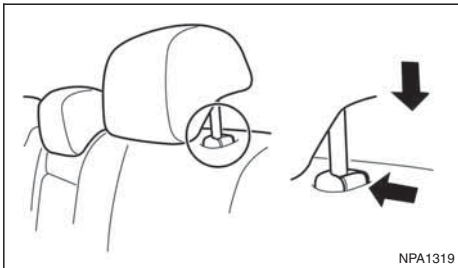

To lower, push and hold the lock knob and push the head restraint down.

PRECAUTIONS ON SEAT BELT USAGE

If you are wearing your seat belt properly adjusted, and you are sitting upright and well back in your seat, your chances of being injured or killed in an accident and/or the severity of injury may be greatly reduced. NISSAN strongly encourages you and all of your passengers to buckle up every time you drive, regardless of whether or not your seating position includes a supplemental air bag.

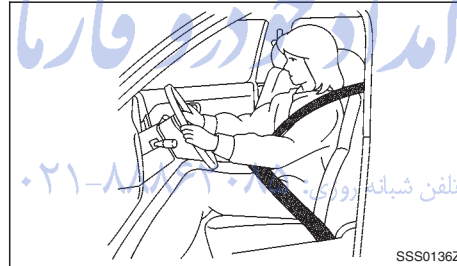

Sit upright and well back

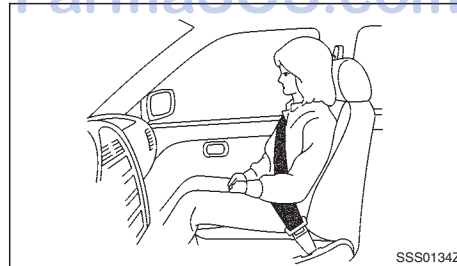

Sit upright and well back



WARNING

Be sure to observe the following warnings when using seat belts. Failure to do so could increase the chance and/or severity of injury in an accident.

- Every person who drives or rides in this vehicle should use a seat belt at all times. Children should be properly restrained in the rear seat and, if appropriate, in a child restraint.
- The seat belt should be properly adjusted to a snug fit. Failure to do so may reduce the effectiveness of the entire restraint system and increase the chance or severity of injury in an accident. Serious injury or death can occur if the seat belt is not worn properly.
- Always route the shoulder belt over your shoulder and across your chest. Never put the belt behind your back, under your arm or across your neck. The belt should be away from your face and neck, but not falling off your shoulder.
- Position the lap belt as low and snug as possible AROUND THE HIPS, NOT THE WAIST. A lap belt worn too high could increase the risk of internal injuries in an accident.
- Seatbelts are designed to bear upon the bony structure of the body, and should be worn low across the front of the pelvis or the pelvis, chest and shoulders, as applicable; wearing the lap section of the belt across the abdominal area must be avoided.

- No modifications or additions should be made by the user which will either prevent the seat belt adjusting devices from operating to remove slack, or prevent the seat belt assembly from being adjusted to remove slack.
- Seat belts should be adjusted as firmly as possible, consistent with comfort, to provide the protection for which they have been designed. A slack belt will greatly reduce the protection afforded to the wearer.
- Be sure the seat belt tongue is securely fastened to the proper buckle.
- Do not wear the seat belt inside out or twisted. Doing so may reduce its effectiveness.
- Do not allow more than one person to use the same seat belt.
- Never carry more people in the vehicle than there are seat belts.
- Each belt assembly must only be used by one occupant; it is dangerous to put a belt around a child being carried on the occupant's lap.
- If the seat belt warning light illuminates continuously while the ignition switch is in the ON position, with all doors closed, and all seat belts fastened, it may indicate a malfunction in the system. Have the system checked by a NISSAN dealer or qualified workshop.
- No changes should be made to the seat belt system. For example, do not modify the seat belt, add material, or install devices that may

change the seat belt routing or tension. Doing so may affect the operation of the seat belt system. Modifying or tampering with the seat belt system may result in serious personal injury.

- Once a seat belt pre-tensioner has been activated, it cannot be reused and must be replaced together with the retractor. See a NISSAN dealer or qualified workshop.
- Removal and installation of the pre-tensioner seat belt system components should be done by a NISSAN dealer or qualified workshop.
- All seat belt assemblies, including retractors and attaching hardware, should be inspected by a NISSAN dealer or qualified workshop after any collision. NISSAN recommends that all seat belt assemblies in use during a collision be replaced unless the collision was minor and the belts show no damage and continue to operate properly. Seat belt assemblies not in use during a collision should also be inspected and replaced if either damage or improper operation is noted.
- All child restraints and attaching hardware should be inspected after any collision. Always follow the restraint manufacturer's inspection instructions and replacement recommendations. The child restraints should be replaced if they are damaged.
- It is essential to replace the entire assembly after it has been worn in a severe impact even if damage to the assembly is not obvious.

- Care should be taken to avoid contamination of the webbing with polishes, oils and chemicals, and particularly battery acid. Cleaning may safely be carried out using mild soap and water. The belt should be replaced if webbing becomes frayed, contaminated or damaged.

CHILD SAFETY

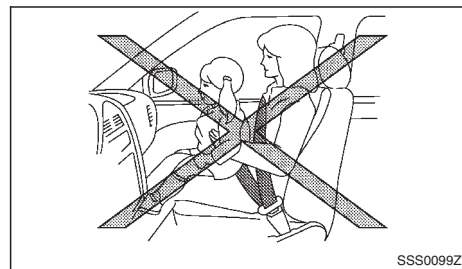

Infants or small children

NISSAN recommends that infants or small children should be seated in a child restraint on the rear seats if available. According to accident statistics, children are safer when properly restrained in the rear seat than in the front seat. See "Child restraints" later in this section. You should choose a child restraint system which fits your vehicle and always follow the manufacturer's instructions for installation and use.

Children

Children who are too large for child restraints should be seated and restrained by the seat belts that are provided.

The use of a booster seat (commercially available) may help to avoid the shoulder belt coming across the face or neck area of a child's seating position. The booster seat should raise the child so that the shoulder belt is properly positioned across the top, middle portion of the shoulder and the lap belt is low on the hips. The booster seat should fit the vehicle's seat. Once the child has grown so the shoulder belt is no longer on or near the face and neck, use the shoulder belt without the booster seat.



WARNING

Never let a child stand or kneel on any seat and do not allow a child in the cargo areas while the vehicle is moving.

PREGNANT WOMEN

NISSAN recommends that pregnant women use seat belts. The seat belt should be worn snug, and always position the lap belt as low as possible around the hips, not the waist. Place the shoulder belt over your shoulder and across your chest. Never put the lap/shoulder belt over your abdominal area. Contact your doctor for specific recommendations.

INJURED PERSONS

NISSAN recommends that injured persons use seat belts, depending on the injury. Check with your doctor for specific recommendations.

SEAT BELT WARNINGS

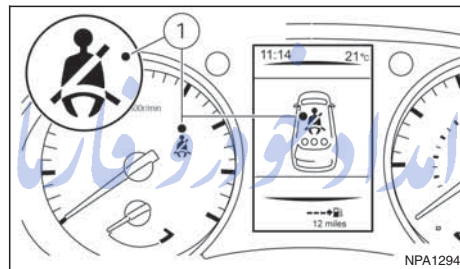

Driver and front passenger

The seat belt warning lights ①, located in the instrument panel, will light up if the driver and/or front passenger seat belts have not been fastened. See "Warning/indicator lights and audible reminders" in the "2. Instruments and controls" section for further details.

Dependant on the vehicle specification the seat belt warning lights, located in the instrument control panel, will either:

- Alert only the driver when his/her seat belt is not securely fastened.
- Alert the driver and/or front passenger when a seat belt is not securely fastened.

Rear passengers

The rear passenger seat belt warning (where fitted) ① is shown in the vehicle information display see "Vehicle information display" in the "2. Instruments and controls" section.

The seat belt warning alerts the driver and/or front passenger if a (rear) seat belt is not securely fastened. The seat belt warning shows a filled circle when the ignition switch is turned to the ON position and an empty circle when the related seat belt has been securely fastened, or after approximately 35 seconds after engine start, or when acknowledged by the driver pushing the steering wheel switch <ENTER> (where fitted).

NOTE

- If there is a change in rear seat belt status during a journey then the applicable symbol for any unbuckled seat will show again for a further 35 seconds.
- The front passenger seat belt warning light will not illuminate if the seat is unoccupied.
- A chime will sound unless the front passenger seat belt is securely fastened when the vehicle speed exceeds 25 km/h (15 MPH). The chime will stop after approximately 90 seconds.

THREE-POINT TYPE SEAT BELT



WARNING

- Do not ride in a moving vehicle when the seatback is reclined. This can be dangerous. The shoulder belt will not be against your body. In an accident, you could be thrown into it and receive neck or other serious injuries. You could also slide under the lap belt and receive serious internal injuries.
- For the most effective protection when the vehicle is in motion, the seat should be upright. Always sit well back in the seat with both feet on the floor and adjust the seat belt properly.

Fastening the seat belts

1. Adjust the seat. (See "Seats" earlier in this section.)
2. Slowly pull the seat belt out of the retractor and insert the tongue into the buckle until you hear and feel the latch engage.



3. Position the lap belt portion **low and snug on the hips** as shown
- The retractor is designed to lock during a sudden stop or on impact. A slow pulling motion permits the belt to move and allows you some freedom of movement in the seat.
- If the seat belt cannot be pulled from its fully retracted position, firmly pull the belt and release it. Then smoothly pull the belt out of the retractor.



4. Pull the shoulder belt portion toward the retractor to take up extra slack. Be sure the shoulder belt is routed over your shoulder and across your chest.

Unfastening the seat belts

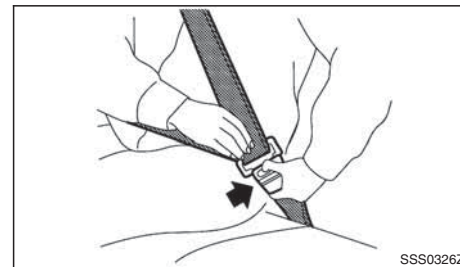

To unfasten the seat belt, push the button on the buckle. The seat belt automatically retracts.

Checking seat belt operation

Seat belt retractors are designed to lock seat belt movement by two separate methods:

- When the belt is pulled quickly from the retractor.
- When the vehicle slows down rapidly.

To increase your confidence in the seat belts, check the operation as follows:

- Grasp the shoulder belt and pull forward quickly. The retractor should lock and restrict further belt movement.

If the retractor does not lock during this check or if you have any questions about seat belt operation, see a NISSAN dealer or qualified workshop.

Shoulder belt height adjustment (where fitted)

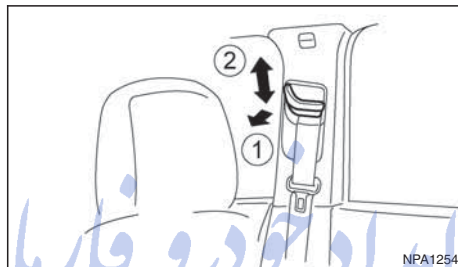

The shoulder belt anchor height should be adjusted to the position that is best for you. (See “Precautions on seat belt usage” earlier in this section.)

To adjust, push (squeeze) the adjustment button ①, and then move the shoulder belt anchor to the preferred position ② so that the belt passes over the centre of the shoulder. The belt should be away from your face and neck, but not falling off of your shoulder. Release the adjustment button to lock the shoulder belt anchor into position.



WARNING

- After adjustment, release the adjustment button and then try to move the shoulder belt anchor up and down to make sure that it is securely fixed in position.

- The shoulder belt anchor height should be adjusted to the position that is best for you. Failure to do so may reduce the effectiveness of the entire restraint system and increase the chance or severity of injury in an accident.

Centre of rear seat

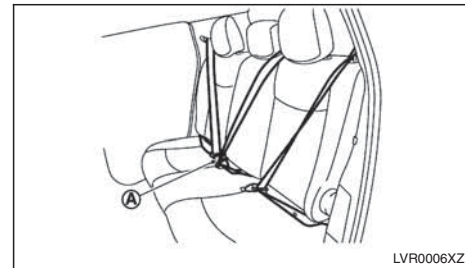

Selecting the correct seat buckle:

The centre seat belt buckle is identified by the CENTRE mark (A). The centre seat belt tongue should only be fastened into the centre seat belt buckle.

SEAT BELT MAINTENANCE

- To clean the seat belt webbing, apply a mild soap solution or any solution recommended for cleaning upholstery or carpets. Then wipe with a cloth and allow the seat belts to dry in the shade. Do not allow the seat belts to retract until they are completely dry.

PRE-TENSIONER SEAT BELT SYSTEM

- If dirt builds up in the shoulder belt guide of the seat belt anchors, the seat belts may retract slowly. Wipe the shoulder belt guide with a clean, dry cloth.
- Periodically check to see that the seat belt and the metal components, such as buckles, tongues, retractors, flexible wires and anchors, work properly. If loose parts, deterioration, cuts or other damage on the webbing is found, the entire seat belt assembly should be replaced.



WARNING

- The pre-tensioner seat belt cannot be reused after activation. It must be replaced together with the retractor as a unit.
- If the vehicle is involved in a frontal collision but the pre-tensioner is not activated, be sure to have the pre-tensioner system checked and, if necessary, replaced by a NISSAN dealer or qualified workshop.
- No unauthorised changes should be made to any components or wiring of the pre-tensioner seat belt system. This is to prevent accidental activation of the pre-tensioner seat belt or damage to the pre-tensioner seat belt operation. Tampering with the pre-tensioner seat belt system may result in serious personal injury.
- Work on and around the pre-tensioner system should be done by an authorised NISSAN dealer or qualified workshop. Installation of electrical equipment should also be done by a NISSAN dealer or qualified workshop. Unauthorised electrical test equipment and probing devices should not be used on the pre-tensioner seat belt system.
- If you need to dispose of the pre-tensioner or scrap the vehicle, contact a NISSAN dealer or qualified workshop. Correct pre-tensioner disposal procedures are set forth in the ap-

propriate NISSAN Service Manual. Incorrect disposal procedures could cause personal injury.

The front seat pre-tensioner seat belt system is activated in conjunction with the front air bag system. It helps tighten the seat belt when the vehicle is involved in certain types of collisions by restraining the seat occupants via the seat belt retractor.

The pre-tensioner is encased with the seat belt's retractor. These seat belts are used in the same way as conventional seat belts.

Additionally, the driver's side pre-tensioner seat belt system is also equipped with a lap pre-tensioner. Both the retractor pre-tensioner and lap pre-tensioner provide significant protection against injury in an accident and increase the safety performance of your vehicle.

When the pre-tensioner seat belt system activates, smoke is released and a loud noise may be heard. The smoke is harmless, but care should be taken not to inhale it as it may cause irritation and choking.

When the ignition switch is in the ON or START position, the Supplemental Restraint System (SRS) air bag warning light will illuminate. The SRS air bag warning light will turn off after approximately 7 seconds if the system is operational. If any of the following conditions occur, the air bag and/or pre-tensioner seat belt need servicing and your vehicle must be taken to the nearest NISSAN dealer or qualified workshop.

CHILD SAFETY

- The air bag warning light remains on after approximately 7 seconds.
- The air bag warning light flashes intermittently.
- The air bag warning light does not come on at all.

Unless checked and repaired, the Supplemental Restraint System (SRS) and/or pre-tensioner seat belt may not function properly. It must be checked and repaired.

When selling your vehicle, we request that you inform the buyer about the pre-tensioner seat belt system and guide the buyer to the appropriate sections in this Owner's Manual.

Children need adults to help protect them.

They need to be properly restrained.

In addition to the general information in this manual, child safety information is available from many other sources, including doctors, teachers, government traffic safety offices, and community organisations. Every child is different, so be sure to learn the best way to transport your child.

There are two basic types of child restraint system:

- Rear-facing child restraints
- Front-facing child restraints

The proper restraint depends on the child's size. Generally, infants (up to about 1 year and less than 9 kg) should be placed in rear-facing child restraints. Front-facing child restraints are available for children who outgrow rear-facing child restraints and are at least 1 year old.



WARNING

Infants and children need special protection. The vehicle's seat belts may not fit them properly. The shoulder belt may come too close to the face or neck. The lap belt may not fit over their small hip bones. In an accident, an improperly fitting seat belt could cause serious or fatal injury. Always use appropriate child restraints.

A child restraint may be secured in the vehicle by using either the ISOFIX child restraint system or with the vehicle seat belt, see "Child restraints" later in this section for more information.

NISSAN recommends that all pre-teens and children be restrained in the rear seat. According to accident statistics, children are safer when properly restrained in the rear seat than in the front seat.

This is especially important because your vehicle has a supplemental restraint system (air bag system) for the front passenger. (See "Supplemental Restraint System (SRS)" later in this section.)

INFANTS

Infants up to at least 1 year old should be placed in a rear-facing child restraint. You should choose a child restraint that fits your vehicle and always follow the manufacturer's instructions for installation and use.

SMALL CHILDREN

Children that are over 1 year old and weigh at least 9 kg can be placed in a front-facing child restraint. Refer to the manufacturer's instructions for minimum and maximum weight and height recommendations. You should choose a child restraint that fits your vehicle and always follow the manufacturer's instructions for installation and use.

LARGER CHILDREN

Children who are too large for a child restraint system should be seated and restrained by the seat belts that are provided. If the child's seating position has a shoulder belt that fits close to the face or neck, the use of a booster seat (commercially available) may help overcome this. The booster seat should raise the child so that the shoulder belt is

CHILD RESTRAINTS

properly positioned across the top, middle portion of the shoulder and the lap belt is low on the hips. The booster seat should also fit the vehicle seat. Once the child has grown so that the shoulder belt is no longer on or near the face or neck of the child, use the shoulder belt without the booster seat. In addition, there are many types of child restraint system available for larger children that should be used for maximum protection.

LEGAL REQUIREMENTS

Check any legal requirements applicable in your location. For example, the U.K. has legal requirements to use child restraints based on height and age, see “Child restraints” later in this section for more information

PRECAUTIONS ON CHILD RESTRAINTS

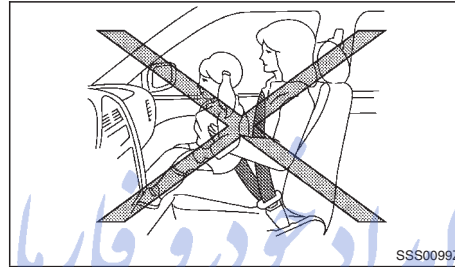

WARNING

- Infants and small children should always be placed in an appropriate child restraint system while riding in the vehicle. Failure to use a child restraint system can result in serious injury or death.
- Infants and small children should never be carried on your lap. It is not possible for even the strongest adult to resist the forces of a severe accident. The child could be crushed between the adult and parts of the vehicle. Also, do not put the same seat belt around a child and yourself.
- Infants and children need special protection. The vehicle's seat belts may not fit them properly. The shoulder belt may come too close to the face or neck. The lap belt may not fit over

their small hip bones. In an accident, an improperly fitting seat belt could cause serious or fatal injury.

- NISSAN recommends that the child restraint system be installed in the rear seat. According to accident statistics, children are safer when properly restrained in the rear seat rather than in the front seat.
- Child restraint systems specially designed for infants and small children are available from several manufacturers. When selecting any child restraint systems, place your child in the child restraint system and check the various adjustments to be sure that the child restraint system is compatible with your child. Always follow the manufacturer's instructions for installation and use.
- Follow all of the child restraint manufacturer's instructions for installation and use. When purchasing a child restraint, be sure to select one which will fit your child and vehicle. It may not be possible to properly install some types of child restraint in your vehicle.
- Check the child restraint system in your vehicle to be sure that it is compatible with the vehicle's seat belt system.
- For a front-facing child restraint system, check to make sure the shoulder belt does not fit close to child's face or neck.

- Never install a rear-facing child restraint system on the front passenger seat without first deactivating the passenger air bag with the front passenger air bag switch (where fitted), see “Front passenger air bag switch (where fitted)” later in this section. In a frontal collision, supplemental front-impact air bags inflate with great force. An inflating supplemental front-impact air bag could seriously injure or kill your child.
- Adjustable seatbacks should be positioned to fit the child restraint system, but as upright as possible.
- If the seat belt in the position where a child restraint system is installed requires a locking device and if it is not used, injuries could result from a child restraint system tipping over during normal vehicle braking or cornering.
- After attaching a child restraint system, test it before you place the child in it. Push it from side to side and tug it forward to make sure that it is held securely in place. The child restraint system should not move more than 25 mm (1 in). If the restraint is not secure, tighten the belt as necessary, or install the restraint in another seat and test it again.
- If a child restraint system is not anchored properly, the risk of a child being injured in a collision or a sudden stop greatly increases.
- Improper use of a child restraint system can increase the risk or severity of injury for both the child and other occupants in the vehicle.

- When the child restraint system is not in use, keep it secured with the ISOFIX child restraint system or a seat belt to prevent it from being thrown around in case of a sudden stop or accident.

NISSAN recommends that infants and small children be seated in a child restraint system. You should choose a child restraint system that fits your vehicle and always follow the manufacturer’s instructions for installation and use. In addition, there are many types of child restraint systems available for larger children that should be used for maximum protection.

CAUTION

Remember that a child restraint left in a closed vehicle can become very hot. Check the seating surface and buckles before placing your child in a child restraint.

CHILD RESTRAINT AND ISOFIX INFORMATION

When selecting any child restraint, keep the following points in mind:

- Choose a child restraint that complies with the latest European safety standard, ECE Regulation 44.04.
- Place your child in the child restraint and check the various adjustments to be sure the child restraint is compatible with your child. Always follow all of the recommended procedures.

- Check the child restraint in your vehicle to be sure it is compatible with vehicle’s seat belt system.
- Refer to the tables later in this section for a list of the recommended fitment positions and the approved child restraints for your vehicle.

Approved universal child restraint positions

Mass group		Suitability			
		Front passenger seat Air bag ON	Front passenger seat Air bag OFF	Rear outer seat	Rear centre seat
0	<10 kg	X	U	U	X
0+	<13 kg	X	①U/L②	①U/L②	X
I	9 to 18 kg	X	③U	③U	X
II	15 to 25 kg	X	④UF	④UF/L⑤	X
III	22 to 36 kg	X	⑥UF	⑥UF/L⑦	X

X: Not suitable for child restraint system

U: Suitable for universal category child restraint system approved for this weight (mass) group

UF: Suitable for forward-facing universal category child restraint system approved for this weight (mass) group

L: Suitable for particular child restraints given in the following table or vehicle list of child restraint manufacturer

#: The circled numbers in the table above correspond to the circled numbers in the following table

FarmaSOS.com

List of suitable Child Restraint Systems (CRS)

Mass group		Suitability			
		Name of CRS	Fixture of CRS	Facing position	Front seat lifter position
0	<10 kg	-	-	-	
0+	<13 kg	①Maxi Cosi Cabrio Fix	Belt mounted	Rear facing	
		②Maxi Cosi Cabrio Fix plus Easy Fix	Belt mounted + base and support leg	Rear facing	Without lifter only
I	9 to 18 kg	③Römer King plus	Belt mounted	Front facing	
II	15 to 25 kg	④Römer Kid fix	Belt mounted	Front facing	Highest
		⑤Römer Kid fix	Belt mounted + ISOFIX	Front facing	N/A
III	22 to 36 kg	⑥Römer Kid fix	Belt mounted	Front facing	Highest
		⑦Römer Kid fix	Belt mounted + ISOFIX	Front facing	N/A

FarmaSOS.com

Approved ISOFIX child restraint positions

Mass group			Suitability		
			Front passenger seat	Rear outer seat	Rear centre seat
Carry-cot	F	ISO/L1	X	X	X
	G	ISO/L2	X	X	X
0 (< 10 kg)	E	ISO/R1	X	IL	X
0+ (< 13 kg)	E	ISO/R1	X	IL ^⑧	X
	D	ISO/R2	X	IL	X
	C	ISO/R3	X	IL ^⑨	X
I (9 to 18 kg)	D	ISO/R2	X	IL	X
	C	ISO/R3	X	IL ^⑨	X
	B	ISO/F2	X	IL, IUF	X
	B1	ISO/F2X	X	^⑩ IL, IUF ^⑪	X
	A	ISO/F3	X	IL, IUF	X
II (15 to 25 kg)			X	IL, IUF	X
III (22 to 36 kg)			X	IL, IUF	X

X: Not suitable for ISOFIX child restraint system

IUF: Suitable for universal category forward-facing child restraint system approved for this weight (mass) group

IL: Suitable for particular ISOFIX category child restraint system (CRS) given in the following table or vehicle list of child restraint manufacturer

⑧: The circled numbers in the table above correspond to the circled numbers in the following table

List of suitable ISOFIX Child Restraint Systems (CRS)

Mass group		Name of CRS	Facing position	Category
0+ (<13 kg)	E	ISO/R1 Maxi Cosi Cabrio Fix plus Easy Fix Base	Rear facing	Semi-universal ⁽⁸⁾
0+ /1 (<18 kg)	E	ISO/R3 BeSafe iZi Kid X3 Isofix	Rear facing	Semi-universal ⁽⁹⁾
I (9 to 18 kg)	B1	ISO/F2X Maxi Cosi pearl plus family fix	Front facing	Semi-universal ⁽¹⁰⁾
		Römer Duo plus	Front facing	Universal ⁽¹¹⁾

تلفن شبانه روزی: ۰۲۱-۸۸۸۶۲۰۸۵

FarmaSOS.com

List of approved Child Restraint Systems (CRS)

Age group	Size Class	Name of CRS	Fixture of CRS	Facing position	Category
0 < 13 kg (Group 0+)	E	Maxi Cosi Cabriofix	EasyFix ISO Base with Support Leg	Rear	Semi-universal
9 to 18 kg (Group I)	B1	Britax Römer Duo	ISO/FX2 Top Tether	Front	Universal

امداد خودرو فارما

تلفن شبانه روزی: ۰۲۱-۸۸۸۶۲۰۸۵

FarmaSOS.com



WARNING

- Never install a rear-facing child restraint system on the front passenger seat without first deactivating the passenger air bag with the front passenger air bag switch (where fitted), see “Front passenger air bag switch (where fitted)” later in this section. In a frontal collision, supplemental front-impact air bags inflate with great force. An inflating supplemental front-impact air bag could seriously injure or kill your child.
- In vehicles equipped with a side air bag system, do not let any infants or small children sit in the front passenger seat as the air bag may cause serious injury in case of deployment during a collision.

NOTE

Child restraints approved to ECE Regulation NO. 44.04 are clearly marked with the categories such as Universal, Semi-universal or ISOFIX.

ISOFIX CHILD RESTRAINT SYSTEM

Your vehicle is equipped with special anchor points that are used with ISOFIX child restraint systems.

ISOFIX lower anchor point locations

The ISOFIX anchor points are provided to install child restraints in the rear outer seating positions only. **Do not attempt to install a child restraint in the centre position using the ISOFIX anchors.**

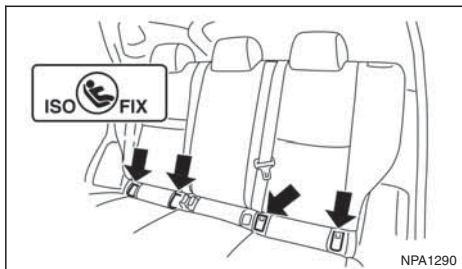

ISO FIX anchor point locations

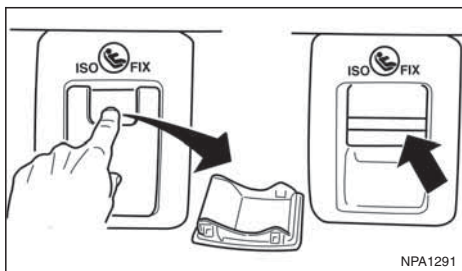

ISO FIX cover removal

The ISO FIX anchor points are located, under covers labelled ISO FIX, at the bottom of the rear seat cushions. To access an ISO FIX anchor point insert your finger into the cover and pull the cover off.

CAUTION

Store the loose ISO FIX covers to avoid losing them and somewhere where they will not get damaged, for example, in the console box see “Console box” in the “2. Instruments and controls” section.

ISO FIX child restraint anchor attachments

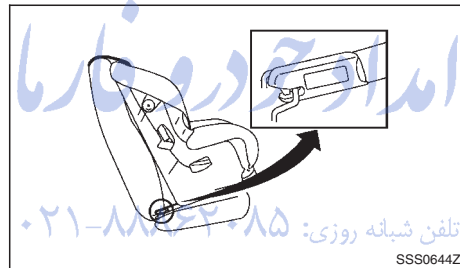

Anchor attachment

ISO FIX child restraints include two rigid attachments that can be connected to two anchors located in the seat. Check your child restraint for a label stating that it is compatible with the ISO FIX child restraints. This information may also be in the instructions provided by the child restraint manufacturer.

ISO FIX child restraints generally require the use of a top tether strap or other anti-rotation devices such as support legs. When installing ISO FIX child restraints, carefully read and follow the instructions in

this manual and those supplied with the child restraints. See “ISO FIX child restraint system” later in this section.

CHILD RESTRAINT ANCHORAGE

Your vehicle is designed to accommodate a child restraint system on the rear seat. When installing a child restraint system, carefully read and follow the instructions in this manual and those supplied with the child restraint system.



WARNING

- Child restraint anchorages are designed to withstand only those loads imposed by correctly fitted child restraints. Under no circumstances are they to be used for adult seat belts, harnesses or for attaching other items or equipment to the vehicle. Doing so could damage the child restraint anchorages. The child restraint will not be properly installed using the damaged anchorage, and a child could be seriously injured or killed in a collision.
- The child restraint top tether strap may be damaged by contact with the parcel shelf or items in the luggage area. Remove the parcel shelf from the vehicle or secure it and any luggage see “Parcel shelf” in the “2. Instruments and controls” section. Your child could be seriously injured or killed in a collision if the top tether strap is damaged.

Anchorage location

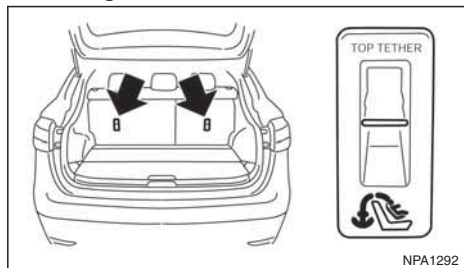

The anchor points are located on the seatback behind the rear outer seating positions and should only be used for child restraints in the rear outer positions.

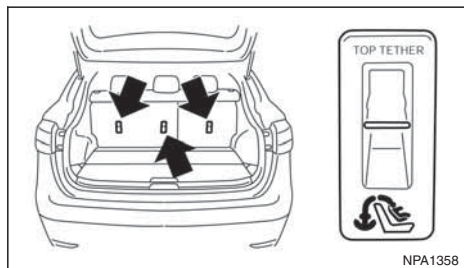

For Australia:

An additional centre anchor point (where fitted) is located on the centre seatback.

CHILD RESTRAINT INSTALLATION USING ISOFIX



WARNING

- Attach ISOFIX child restraints only at the specified locations. For the ISOFIX lower anchor locations, see “ISOFIX lower anchor point locations” earlier in this section. If a child restraint is not secured properly, your child could be seriously injured or killed in an accident.
- Do not install child restraints that require the use of a top tether strap to seating positions that do not have a top tether anchor.
- Do not secure a child restraint in the centre rear seating position using the ISOFIX lower anchors. The child restraint will not be secured properly.
- Inspect the lower anchors by inserting your fingers into the lower anchor area and feeling to make sure there are no obstructions over the ISOFIX anchors, such as seat belt webbing or seat cushion material. The child restraint will not be secured properly if the ISOFIX anchors are obstructed.
- Child restraint anchorages are designed to withstand only those loads imposed by correctly fitted child restraints. Under no circumstance are they to be used for adult seat belts, harnesses or for attaching other items or equipment to the vehicle.

Installation on rear outer seats

Front-facing:

Be sure to follow the manufacturer's instructions for the proper use of your child restraint. Follow these steps to install a front-facing child restraint on the rear outer seats using ISOFIX:

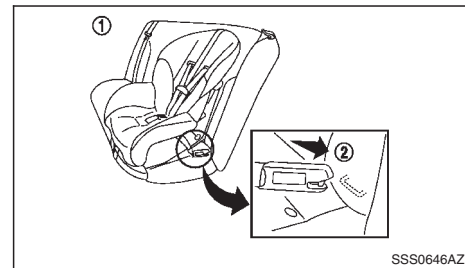

Steps 1 and 2

1. Position the child restraint on the seat ①.
2. Secure the child restraint anchor attachments to the ISOFIX lower anchors ②.
3. The back of the child restraint should be secured against the vehicle seat back. If necessary, adjust or remove the head restraint to obtain the correct child restraint fit. (See “Head restraints” earlier in this section.) If the head restraint is removed, store it in a secure place. Be sure to install the head restraint when the child restraint is removed. If the seating position does not have an adjustable head restraint and it is interfering with the proper child restraint fit, try another seating position or a different child restraint.

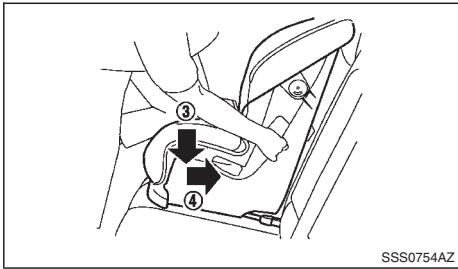

Step 4

4. Shorten the rigid attachment to have the child restraint firmly tightened; press downward (3) and rearward (4) firmly in the centre of the child restraint with your knee to compress the vehicle seat cushion and seatback.
5. If the child restraint is equipped with a top tether strap, route the top tether strap and secure the tether strap to the tether anchor point. (See "Child restraint anchorage" earlier in this section.)
6. If the child restraint is equipped with other anti-rotation devices such as support legs, use them instead of the top tether strap following the child restraint manufacturer's instructions.

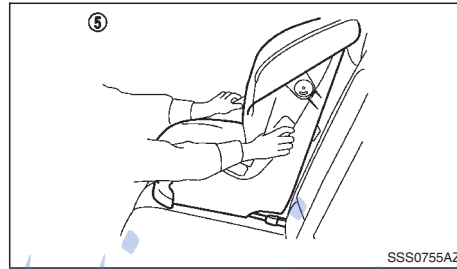

Step 7

7. Test the child restraint before you place the child in it (5). Push the child restraint from side to side and tug it forward to make sure that it is held securely in place.
8. Check to make sure that the child restraint is properly secured prior to each use. If the child restraint is loose, repeat steps 3 through 7.

FarmaSOS.com

Rear-facing:

Be sure to follow the manufacturer's instructions for the proper use of your child restraint. Follow these steps to install a rear-facing child restraint on the rear outer seats using ISOFIX:

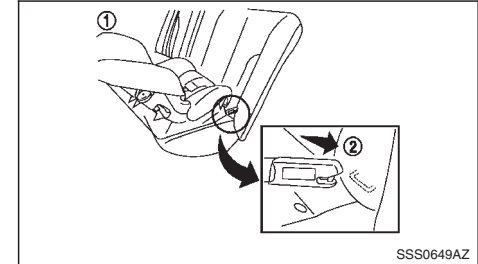

Steps 1 and 2

1. Position the child restraint on the seat (1).
2. Secure the child restraint anchor attachments to the ISOFIX lower anchors (2).

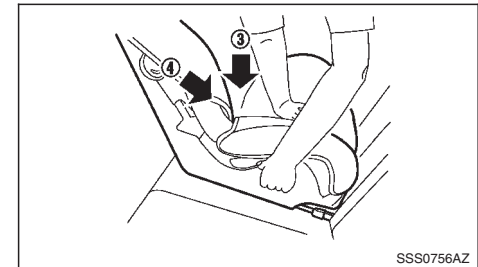

Step 3

- Shorten the rigid attachment to have the child restraint firmly tightened; press downward ③ and rearward ④ firmly in the centre of the child restraint with your hand to compress the vehicle seat cushion and seatback. If any contact occurs between the child restraint and the front seat, slide the front seat forward until contact no longer occurs.
- If the child restraint is equipped with a top tether strap, route the top tether strap and secure the tether strap to the tether anchor point. (See “Child restraint anchorage” earlier in this section.)
- If the child restraint is equipped with other anti-rotation devices such as support legs, use them instead of the top tether strap following the child restraint manufacturer’s instructions.

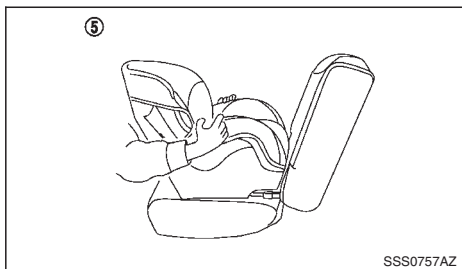

Step 6

- Test the child restraint before you place the child in it ⑤. Push the child restraint from side to side and tug it forward to make sure that it is held securely in place.

- Check to make sure that the child restraint is properly secured prior to each use. If the child restraint is loose, repeat steps 3 through 6.

CHILD RESTRAINT INSTALLATION USING THREE-POINT TYPE SEAT BELT

Installation on rear seats

Front-facing:

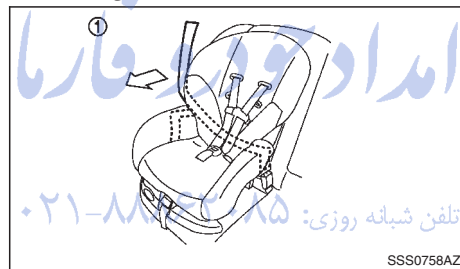

Step 1

Be sure to follow the manufacturer’s instructions for the proper use of your child restraint. Follow these steps to install a front-facing child restraint on the rear seats using 3-point type seat belt without automatic locking mode:

- Position the child restraint on the seat ①. If any contact occurs between the child restraint and the front seat, slide the front seat forward until contact no longer occurs.

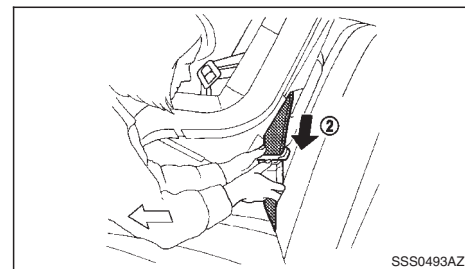

Step 2

- Route the seat belt tongue through the child restraint and insert it into the buckle ② until you hear and feel the latch engage.
- To prevent slack in the seat belt webbing, it is necessary to secure the seat belt in place with locking devices attached to the child restraint.

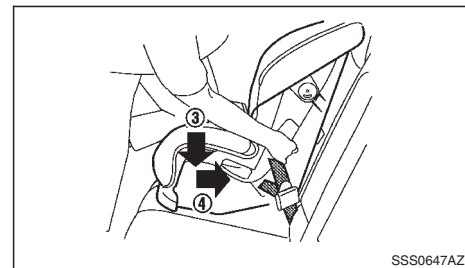

Step 4

- Remove any additional slack from the seat belt; press downward ③ and rearward ④ firmly in the centre of the child restraint with your knee to compress the vehicle seat cushion and seatback while pulling up on the seat belt.

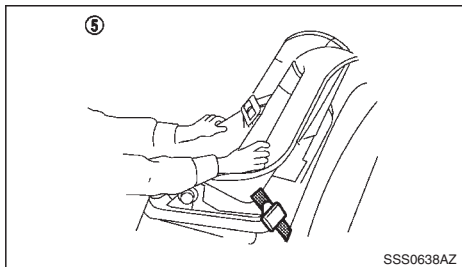

Step 5

- Test the child restraint before you place the child in it ⑤. Push the child restraint from side to side and tug it forward to make sure that it is held securely in place.
- Check to make sure that the child restraint is properly secured prior to each use. If the child restraint is loose, repeat steps 3 through 5.

Rear-facing:

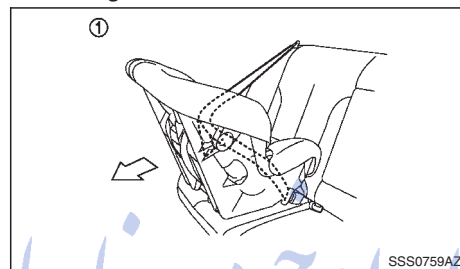

Step 1

Be sure to follow the manufacturer's instructions for the proper use of your child restraint. Follow these steps to install a rear-facing child restraint on the rear seats using 3-point type seat belt without automatic locking mode:

- Position the child restraint on the seat ①.

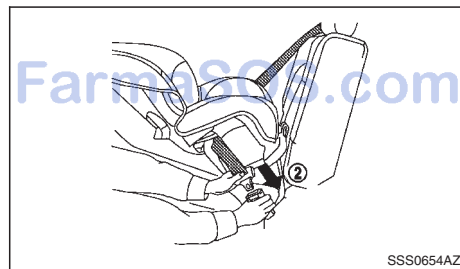

Step 2

- Route the seat belt tongue through the child restraint and insert it into the buckle ② until you hear and feel the latch engage.

- To prevent slack in the seat belt webbing, it is necessary to secure the seat belt in place with locking devices attached to the child restraint.

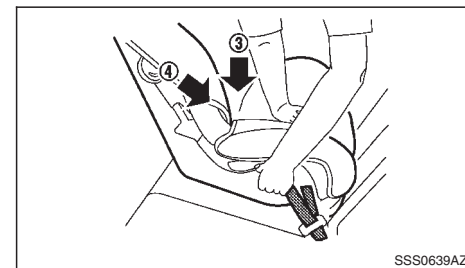

Step 4

- Remove any additional slack from the seat belt; press downward ③ and rearward ④ firmly in the centre of the child restraint with your hand to compress the vehicle seat cushion and seatback while pulling up on the seat belt.

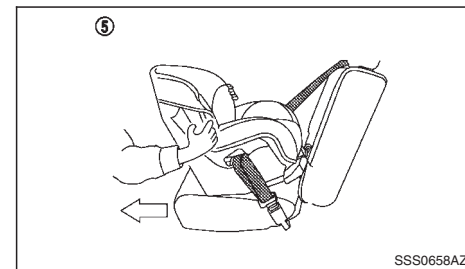

Step 5

5. Test the child restraint before you place the child in it ⑤. Push the child restraint from side to side and tug it forward to make sure that it is held securely in place.
6. Check to make sure that the child restraint is properly secured prior to each use. If the child restraint is loose, repeat steps 3 through 5.

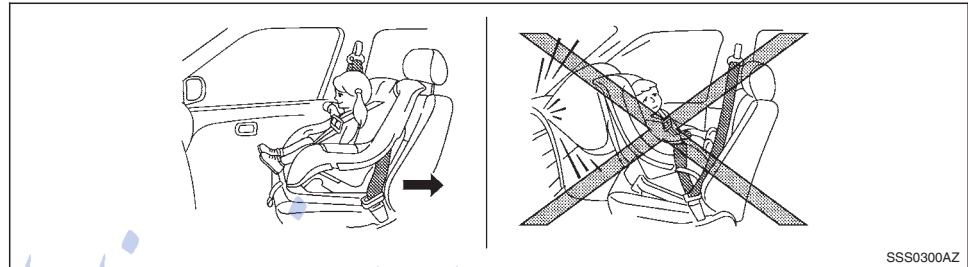

SSS0300AZ

Installation on front passenger's seat



WARNING

- Never install a rear-facing child restraint system on the front passenger seat without first deactivating the passenger air bag with the front passenger air bag switch (where fitted), see "Front passenger air bag switch (where fitted)" later in this section. In a frontal collision, supplemental front-impact air bags inflate with great force. An inflating supplemental front-impact air bag could seriously injure or kill your child.
- Never install a child restraint with a top tether strap on the front seat.
- NISSAN recommends that a child restraint be installed on the rear seat. However, if you must install a child restraint on the front passenger's seat, move the passenger's seat to the rearmost position.

- Child restraints for infants must be used in the rear-facing direction and therefore must not be used on the front passenger's seat when the front passenger's air bag has not been deactivated.

Front-facing:

Be sure to follow the manufacturer's instructions for the proper use of your child restraint. Follow these steps to install a front-facing child restraint on the front passenger's seat using a 3-point type seat belt without automatic locking mode:

1. Turn off the front passenger air bag using the front passenger air bag switch. (See "Supplemental Restraint System (SRS)" later in this section.) Turn the ignition switch to the ON position and make sure that the front air bag status light  illuminates.

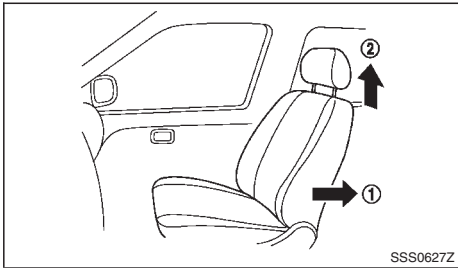

Steps 2 and 3

SSS0627Z

2. Move the seat to the rearmost position ①.
3. Adjust the head restraint to its highest position ②. Remove it if it interferes with the child restraint installation. In such situations, securely store the head restraint in the luggage compartment so that it does not become a dangerous projectile during a sudden stop or in an accident.
4. Position the child restraint in the seat.

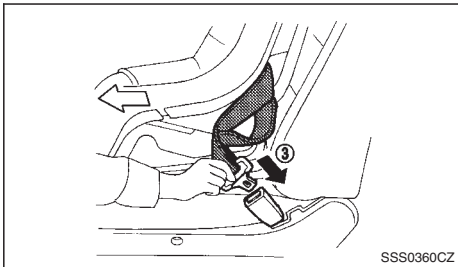

Step 5

SSS0360CZ

5. Route the seat belt tongue through the child restraint and insert it into the buckle ③ until you hear and feel the latch engage.
6. To prevent slack in the seat belt webbing, it is necessary to secure the seat belt in place with locking devices attached to the child restraint.

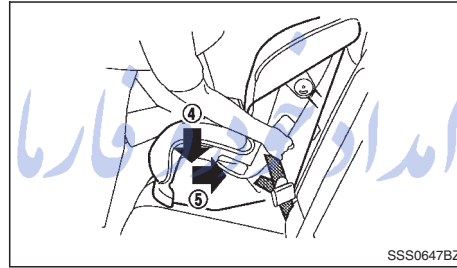

Step 7

SSS0647BZ

7. Remove any additional slack from the seat belt; press downward ④ and rearward ⑤ firmly in the centre of the child restraint with your knee to compress the vehicle seat cushion and seatback while pulling up on the seat belt.

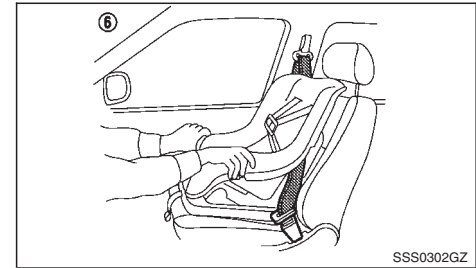

Step 8

SSS0302GZ

8. Test the child restraint before you place the child in it ⑥. Push the child restraint from side to side and tug it forward to make sure that it is held securely in place.
9. Check to make sure that the child restraint is properly secured prior to each use. If the child restraint is loose, repeat steps 5 through 8.

Rear facing:

If you must install a child restraint system in the front seat, follow these steps:

1. Turn off the front passenger air bag using the front passenger air bag switch. (See "Supplemental Restraint System (SRS)" later in this section.) Turn the ignition switch to the ON position and make sure that the front air bag status light  illuminates.

SUPPLEMENTAL RESTRAINT SYSTEM (SRS)

PRECAUTIONS ON SUPPLEMENTAL RESTRAINT SYSTEM (SRS)

This Supplemental Restraint System (SRS) section contains important information concerning the driver's and passenger's supplemental front impact air bags, front seat-mounted side-impact supplemental air bags, roof-mounted curtain side-impact air bags, and pre-tensioner seat belts.

Supplemental front-impact air bag system

This system can help cushion the impact force to the head and chest area of the driver and/or front passenger in certain frontal collisions. The supplemental front-impact air bag is designed to inflate on the front where the vehicle is impacted.

Front seat-mounted side-impact supplemental air bag system (where fitted)

This system can help cushion the impact force to the chest and pelvis areas of the driver and front passenger in certain side-impact collisions. The front seat-mounted side-impact supplemental air bag is designed to inflate on the side where the vehicle is impacted.

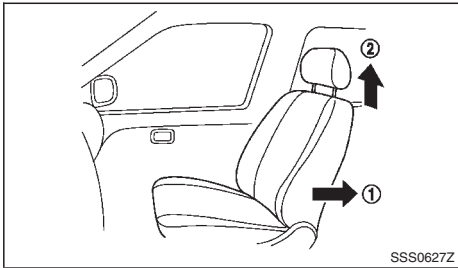

Steps 2 and 3

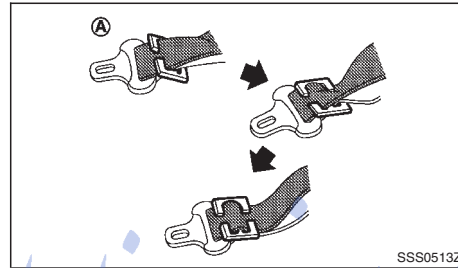

2. Move the seat to the rearmost position.
3. Adjust the head restraint to its highest position. Remove it if it interferes with the child restraint installation. In such situations, securely store the head restraint in the luggage compartment so that it does not become a dangerous projectile during a sudden stop or in an accident.
4. Position the child restraint system in the front passenger seat.
Always follow the child restraint system manufacturer's instructions for installation and use.
5. Route the seat belt tongue through the child restraint system and insert it into the buckle until you hear and feel the latch engage. To prevent slack in the lap belt, secure the shoulder belt in place with a locking clip (A). Use a locking clip attached to the child restraint system, or one which is equivalent in dimensions and strength.
Be sure to follow the child restraint system manufacturer's instructions for belt routing.
6. Slide the seat forwards so that the seat belt fully tightens the child restraint system and the child restraint reaches the vehicle dashboard.
7. Test the child restraint system before you place the child in it. Check that it does not tilt too far from side to side. Try to tug it forwards and check if it is held securely in place.

Roof-mounted curtain side-impact supplemental air bag system (where fitted)

This system can help cushion the impact force to the head of the driver and passengers in front and rear outer seating positions in certain side-impact collisions. The roof-mounted curtain side-impact supplemental air bag is designed to inflate on the side where the vehicle is impacted.

The SRS is designed to **supplement** the crash protection provided by the driver and front passenger seat belts and is **not designed to substitute** them. Seat belts should always be correctly worn and the driver and front passenger seated a suitable distance away from the steering wheel, instrument panel and front door finishers. For additional information, see “Seat belts” earlier in this section.

After placing the ignition switch in the ON or START position, the air bag warning light will illuminate. The air bag warning light will turn off after approximately 7 seconds if the system is operational. See “Warning/indicator lights and audible reminders” in the “2. Instruments and controls” section for further details.

The air bag will operate only when the ignition switch is in the ON or START position.

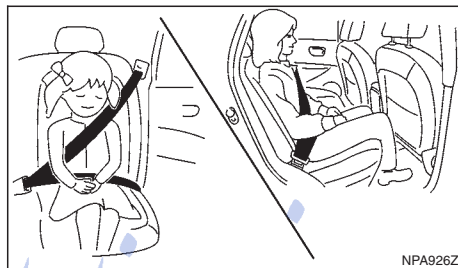

Correct (rear) seating positions

Driver and front passenger air bags:



WARNING

- The supplemental front-impact air bags ordinarily will not inflate in the event of a side impact, rear impact, rollover, or lower severity frontal collision. Always wear the seat belts to help reduce the risk or severity of injury in accidents.
- The seat belts and the supplemental front-impact air bags are most effective when you are sitting well back and upright in the seat. The front-impact air bags inflate with great force. If you are unrestrained, leaning forward, sitting sideways, or out of position in any way, you are at greater risk of injury or death in an accident. You may also receive serious or fatal injuries from the supplemental front-impact air bag if you are up against it when it

inflates. Always sit back against the seatback and as far away as practical from the steering wheel. Always use the seat belts.

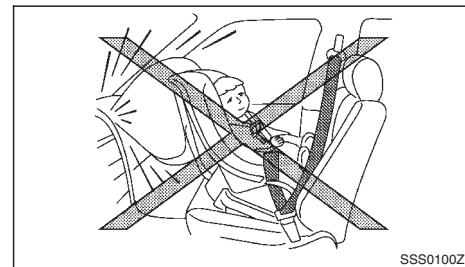

WARNING

- Never install a child restraint system in the front seat. An inflating supplemental front-impact air bag could seriously injure or kill your child (see “Air bag warning labels” later in this section).
- Children may be severely injured or killed when the air bags inflate if they are not properly restrained see “Child restraints” earlier in this section.
- Never let children ride unrestrained or extend their hands or face out of the window. Do not attempt to hold them in your lap or arms.

Side and curtain air bags (where fitted):



WARNING

- The front seat-mounted side-impact supplemental air bags and roof-mounted curtain side-impact supplemental air bags ordinarily will not inflate in the event of a front impact, rear impact, rollover, or lower severity side collision. Always wear the seat belts to help reduce the risk or severity of injury in accidents.
- The seat belts, the front seat-mounted side-impact supplemental air bags and roof-mounted curtain side-impact supplemental air bags are most effective when you are sitting well back and upright in the seat. The front seat-mounted side-impact supplemental air bags and roof-mounted curtain side-impact supplemental air bags inflate with great force. If you and your passengers are unrestrained, leaning forward, sitting sideways, or out of position in any way, you and your passengers are at greater risk of injury or death in an accident.
- Do not allow anyone to place their hands, legs, or face near the front seat-mounted side-impact supplemental air bags and roof-mounted curtain side-impact supplemental air bags on the sides of the seatback of the front seats or near the side roof rails. Do not allow anyone sitting in the front seats or rear outer seats to extend their hands out of the windows or lean against the doors.

- When sitting in the rear seats, do not hold onto the seatback of the front seats. If the front seat-mounted side impact supplemental air bags and roof-mounted curtain side-impact supplemental air bags inflate, you may be seriously injured. Be especially careful with children, who should always be properly restrained.
- Do not use seat covers on the front seatbacks. They may interfere with the front seat-mounted side-impact supplemental air bag inflations.

NOTE

For an overview see “Seat belts and supplemental restraint system” in the “0. Illustrated table of contents” section.

Pre-tensioner seat belt system

The pre-tensioner seat belt system may activate with the supplemental air bag system in certain types of collisions.

Working with the seat belt retractor and anchor, it helps tighten the seat belt the instant the vehicle becomes involved in certain types of collisions, helping to restrain front seat occupants. See “Pre-tensioner seat belt system” earlier in this section.

Air bag warning labels

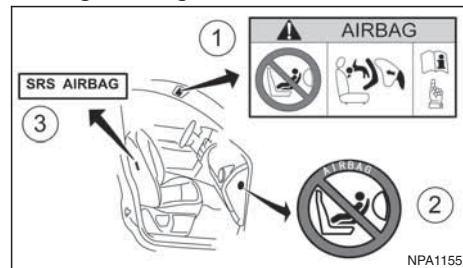

- ① **SRS air bag warning label:** The warning label is located on the surface of the front passenger sun visor.
- ② **SRS front passenger air bag warning label:** The warning label is located on the outer side of the instrument panel (passenger side).
- ③ **SRS side air bag warning label:** The warning label is located on the side of the passenger side centre pillar. Tags are also sewn into the front seat covers.

SRS front-impact passenger air bag:

The warning label ① is located on the sun visor.

“NEVER use a rearward facing child restraint on a seat protected by an ACTIVE AIRBAG in front of it, DEATH or SERIOUS INJURY to the CHILD can occur.”

The **BACK SEAT** is the **SAFEST** place for children aged 12 and under. Always use seat belts and child restraints. For maximum safety protection in all types of crashes, you must always wear your safety belt. Do not sit or lean unnecessarily close to the airbag. Do not place any objects over the airbag or between the airbag and yourself. If the airbag warning light stays on or is flashing when the ignition switch is placed in the ON position, go to a NISSAN dealer or qualified workshop. Airbags can only be removed or disposed of by a NISSAN dealer or qualified workshop.

Be sure to read the "AIRBAG LABEL" description at the end of this manual.

In vehicles equipped with a front-impact passenger air bag system, use a rear-facing child restraint system only on the rear seats.

When installing a child restraint system in your vehicle, always follow the child restraint system manufacturer's instructions for installation. For information, see "Child restraints" earlier in this section.

SRS air bag warning light

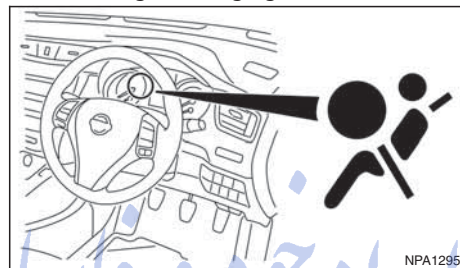

The SRS air bag warning light, displaying  in the instrument panel, monitors the circuits of the supplemental front-impact air bag, front seat-mounted side-impact supplemental air bag (where fitted), supplemental curtain side-impact air bags (where fitted), and pre-tensioner seat belt systems. The circuits monitored by the SRS air bag warning light are the diagnosis sensor unit, crash zone sensor, satellite sensors, front impact air bag modules, front seat-mounted side-impact supplemental air bag modules (where fitted), roof-mounted curtain side-impact supplemental air bag modules (where fitted), pre-tensioner seat belt systems, and all related wiring.

After placing the ignition switch in the ON or START position, the supplemental air bag warning light illuminates. The air bag warning light will turn off after approximately 7 seconds if the system is operational.

Have the air bag systems and/or pre-tensioner seat belt systems serviced at the nearest NISSAN dealer or qualified workshop if any of the following conditions occur:

- The SRS air bag warning light remains on after approximately 7 seconds.
- The SRS air bag warning light flashes intermittently.
- The SRS air bag warning light does not illuminate at all.

Under these conditions, the air bag systems and/or pre-tensioner seat belt systems may not operate properly. They must be checked and repaired. Contact a NISSAN dealer or qualified workshop immediately.

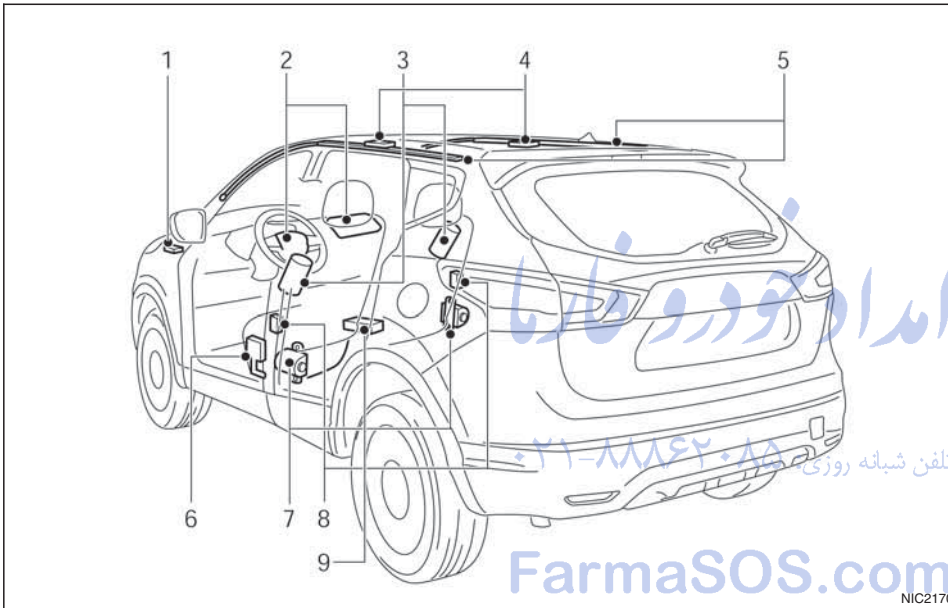

SUPPLEMENTAL AIR BAG SYSTEMS

1. Crash zone sensor
2. Supplemental front-impact air bag modules
3. Front seat-mounted side-impact supplemental air bag modules
4. Roof-mounted curtain side-impact supplemental air bags inflators
5. Roof-mounted curtain side-impact supplemental air bag modules
6. Lap outer pre-tensioner (driver's side)
7. Seat belt with pre-tensioners
8. Satellite sensors
9. Air bag Control Unit (ACU)



WARNING

- Do not place any objects on the steering wheel pad. Do not place any objects between the driver and steering wheel pad. Such objects may become dangerous projectiles and cause injury if a supplemental air bag inflates.
- Immediately after inflation, several supplemental air bag system components will be hot. Do not touch them: you may severely burn yourself.
- No unauthorised changes should be made to any components or wiring of the supplemental air bag systems. This is to prevent accidental inflation of the supplemental air bags or damage to the supplemental air bag systems.
- Do not make unauthorised changes to your vehicle's electrical system, suspension system or front end structure. This could affect proper operation of the supplemental air bag systems.
- Tampering with the supplemental air bag systems may result in serious personal injury. Tampering includes changes to the steering wheel by placing materials over the steering wheel pad and above, and by installing additional trim materials around the supplemental air bag systems.

- **Work around and on the supplemental air bag systems should be done by a NISSAN dealer or qualified workshop. The SRS wiring should not be modified or disconnected. Unauthorised electrical test equipment and probing devices should not be used on the supplemental air bag systems.**
- **The SRS wiring harness connectors are yellow and/or orange for easy identification.**
- **Never install a rear-facing child restraint system on the front passenger seat without first deactivating the passenger air bag with the front passenger air bag switch (where fitted), see “Front passenger air bag switch (where fitted)” later in this section. In a frontal collision, supplemental front-impact air bags inflate with great force. An inflating supplemental front-impact air bag could seriously injure or kill your child.**

When the air bags inflate, a fairly loud noise may be heard, followed by the release of smoke. This smoke is not harmful and does not indicate a fire. However, care should be taken not to inhale it, as it may cause irritation and choking. Occupants with a history of breathing difficulties, such as asthma, should get fresh air promptly.

Supplemental air bags, along with the use of seat belts, help to cushion the impact force on the chest of the front occupants. Curtain air bags help to cushion the impact force to the head of occupants in the front and rear outer seating positions. They can help save lives and reduce serious injuries. However, an

inflating side air bag and curtain air bag may cause abrasions or other injuries. Supplemental side air bags and curtain air bags do not provide restraint to the lower body.

Supplemental front-impact air bag system

The driver's supplemental front-impact air bag is located at the centre of the steering wheel. The passenger's supplemental front-impact air bag is located at the instrument panel above the glove box.

The supplemental front-impact air bag system is designed to inflate in higher severity frontal collisions, although it may inflate if the forces in another type of collision are similar to those of a higher severity frontal impact. It may not inflate in certain frontal collisions. Vehicle damage (or lack of it) is not always an indication of proper supplemental front-impact air bag system operation.



WARNING

Never install a rear-facing child restraint system on the front passenger seat without first deactivating the passenger air bag with the front passenger air bag switch (where fitted), see “Front passenger air bag switch (where fitted)” later in this section. In a frontal collision, supplemental front-impact air bags inflate with great force. An inflating supplemental front-impact air bag could seriously injure or kill your child.



For models with front passenger air bag switch: The front passenger air bag is designed to be turned off using the front passenger air bag switch, only if absolutely necessary.

Front passenger air bag status light (where fitted):





! WARNING



- Since your vehicle is equipped with a front passenger air bag, it is not permitted to install a rearward facing child restraint on the front passenger seat unless the front passenger air bag has been deactivated first.
- Do not fit a rearward facing child seat on the front passenger seat if the air bag activation/deactivation system (where fitted) is malfunctioning. Your vehicle must immediately be taken to a NISSAN dealer or qualified workshop in such a situation.

The front passenger air bag status lights  and  are located on the instrument panel above the shift lever.

When the ignition switch is placed in the ON position, the front passenger air bag status ON and OFF lights illuminate and then turn off or remain on depending on the front passenger air bag status.

- When the ignition switch is placed in the ON position and the front passenger air bag is active, both the front passenger air bag status OFF light  and the Supplemental Restraint System (SRS) air bag warning light  in the combination meter ① will turn off after about 7 seconds.

The front passenger air bag status ON light  will illuminate and then turn off after a period of time when the front passenger air bag switch is in the ON position.

- When the ignition switch is placed in the ON position and the front passenger air bag is inactive, both the front passenger air bag status ON light , and the Supplemental Restraint System (SRS) air bag warning light  in the combination meter ① will turn on after about 7 seconds.

The front passenger air bag status OFF light  will illuminate and remain on as long as the front passenger air bag switch is in the OFF position.

If the front passenger air bag status light operates in a way other than described above, the front passenger air bag may not function properly. Have the system checked, and if necessary repaired, by a NISSAN dealer or qualified workshop promptly.

Front passenger air bag switch (where fitted):

The front passenger air bag can be turned off with the front passenger air bag switch (A) located inside the glove box.

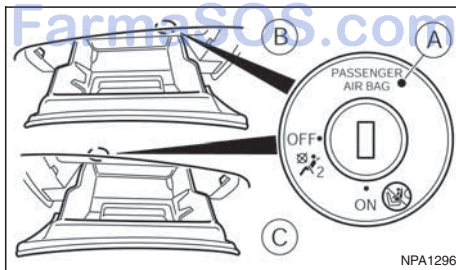

- (A) Air bag switch (where fitted)
- (B) Left Hand Drive models
- (C) Right Hand Drive models

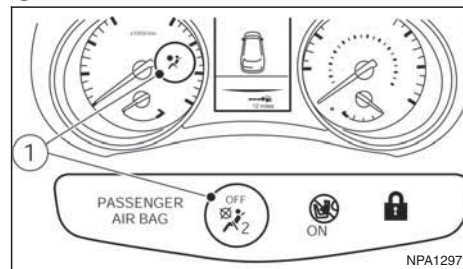

To turn off the front passenger air bag:

1. Place the ignition switch in the "OFF" position.
2. Open the glove box and insert the key into the front passenger air bag switch. For Intelligent Key equipped models, see "Keys" in the "3. Pre-driving checks and adjustments" section for mechanical key usage.
3. Push and turn the key to the OFF position.
4. Place the ignition switch in the ON position. The front passenger air bag status OFF light  will illuminate and remain on.

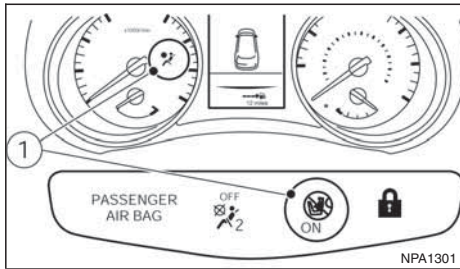

To turn on the front passenger air bag:

1. Place the ignition switch in the "OFF" position.
2. Open the glove box and insert the key into the front passenger air bag switch.
3. Push and turn the key to the ON position.
4. Place the ignition switch in the ON position. The front passenger air bag status ON light  will illuminate, and after a period of time, will then turn off.

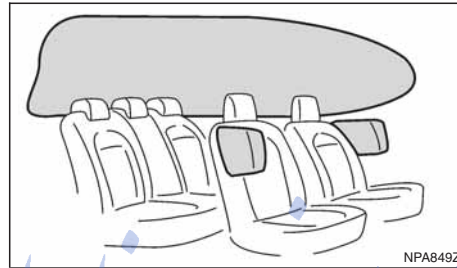

Supplemental side-impact air bag system

The supplemental side air bags are located in the outside of the seatback of the front seats.

The supplemental side-impact air bag system is designed to inflate in higher severity side collisions, although it may inflate if the forces in another type of collision are similar to those of a higher severity side impact. It may not inflate in certain side collisions. Vehicle damage (or lack of it) is not always an indication of proper supplemental side-impact air bag system operation.

The seat belts should be correctly worn and the driver and passenger seated upright, and as far as is practical, away from the side air bag. The side air bags inflate quickly in order to help protect the front occupants. Because of this, the force of the side air bags inflating can increase the risk of injury if the

occupant is too close to, or is against, these air bag modules during inflation. The side air bag will deflate quickly after the collision is over.

Supplemental side-impact curtain air bag system (where fitted)

The supplemental side-impact curtain air bag is located in the roof side trims.

The supplemental side-impact curtain air bag system is designed to inflate in higher severity side collisions, although it may inflate if the forces in another type of collision are similar to those of a higher severity side impact. It may not inflate in certain side collisions. Vehicle damage (or lack of it) is not always an indication of proper supplemental curtain side-impact air bag system operation.

The seat belts should be correctly worn and the rear seat passengers should be seated as far away as practical from the door finishers and side roof rails. The curtain air bags inflate quickly in order to help protect the front and rear occupants. Because of this, the force of the curtain air bag inflating can increase the risk of injury if the occupant is too close to, or is against, these air bag modules during inflation. The curtain air bag will deflate quickly after the collision is over.



WARNING

- **Directly after inflation, several air bag system components will be hot. Do not touch them; you may severely burn yourself.**

- No unauthorised changes should be made to any components or wiring of the air bag system. This is to prevent accidental inflation of the air bag or damage to the air bag system.
- Tampering with the air bag system may result in serious personal injury. Tampering includes making changes to the steering wheel and the instrument panel assembly by placing material over the steering pad and above the dashboard, or by installing additional trim material around the air bag system.
- Do not attach any objects to the steering wheel pad or to the instrument panel. Objects attached to the steering wheel pad and instrument panel may become dangerous projectiles and cause injury if the air bag inflates.
- Work on and around the air bag system should be done by a NISSAN dealer or qualified workshop. Installation of electrical equipment should be done by a NISSAN dealer or qualified workshop. The yellow SRS wiring harnesses* should not be modified or disconnected. Unauthorised electrical test equipment and probing devices should not be used on the air bag system.

* SRS wiring harnesses are covered with yellow insulation either just before the harness connectors or on the complete harness, for easy identification.

REPAIR AND REPLACEMENT PROCEDURE



WARNING

- Once the air bags have been inflated, the air bag modules will not function and must be replaced. The air bag modules must be replaced by a NISSAN dealer or qualified workshop. The inflated air bag modules cannot be repaired.
- The air bag systems should be inspected by a NISSAN dealer or qualified workshop if there is any damage to the front end portion of the vehicle.
- When selling your vehicle, we request that you inform the buyer about the air bag system and guide the buyer to the appropriate sections in this Owner's Manual.
- If you need to dispose of the SRS or scrap the vehicle, contact a NISSAN dealer or qualified workshop. Correct disposal procedures are set forth in the appropriate NISSAN Service Manual. Incorrect disposal procedures could cause personal injury.

The air bags and pre-tensioner seat belts are designed to activate on a one-time-only basis. As a reminder, unless the SRS air bag warning light is damaged, the SRS air bag warning light remains illuminated after inflation has occurred. The repair and replacement of the SRS should be done only by a NISSAN dealer or qualified workshop.

When maintenance work is required on the vehicle, information about the air bags, pre-tensioner seat belts and related parts should be pointed out to the person performing the maintenance. The ignition switch should always be in the LOCK position when working under the bonnet or inside the vehicle.

2 Instruments and controls

Meters and gauges	2-2	Headlight switch	2-36
Speedometer	2-2	Turn signal switch	2-38
Fuel gauge	2-2	Fog light switch	2-38
Tachometer	2-2	Front fog light (where fitted)	2-38
Engine coolant temperature gauge	2-3	Rear fog light (where fitted)	2-39
Instrument panel brightness control	2-3	Headlight aiming control	2-39
Warning/indicator lights and audible reminders	2-4	Headlight aiming control switch (where fitted)	2-39
Checking bulbs	2-4	Automatic aiming control (LED headlights)	2-40
Warning lights	2-5	Headlight cleaner (where fitted)	2-40
Indicator lights	2-10	Headlight cleaner switch (where fitted)	2-40
Audible reminders	2-12	Horn	2-41
Vehicle information display	2-13	Seat heating (where fitted)	2-41
How to use the Vehicle Information Display	2-14	Power outlet	2-42
Startup display	2-14	Storage	2-42
Settings	2-14	Storage trays	2-42
Vehicle information display warnings and indicators	2-21	Glove box	2-42
Trip computer	2-27	Console box	2-43
[Clock] and [outside air temperature]	2-29	Cup holders	2-44
Traffic sign recognition (where fitted)	2-30	Bottle holder	2-44
Wiper and washer switch	2-32	Coat hooks	2-44
Windscreen	2-32	Map pocket (where fitted)	2-44
Rear window	2-33	Seat pocket (where fitted)	2-44
ThermaClear Heated Windscreen button	2-34	Roof rail (where fitted)	2-45
ThermaClear Heated Windscreen (where fitted)	2-34	Parcel shelf	2-45
Defogger switch	2-35	Luggage compartment/boot floor (where fitted)	2-47
Rear window defogger	2-35	Luggage hooks	2-47
Outside mirror defogger (where fitted)	2-35	Windows	2-48
Headlight and turn signal switch	2-36	Power windows	2-48
		Fixed glass roof (where fitted)	2-49

Sunshade operation.....	2-50	Rear room/reading light (where fitted)	2-51
Interior lights.....	2-50	Luggage compartment light	2-51
Room light control switch.....	2-50	Vanity mirror light (where fitted).....	2-51
Map lights (where fitted)	2-50		

امداد خودرو فارما

تلفن شبانه روزی: ۰۲۱-۸۸۸۶۲۰۸۵

FarmaSOS.com

METERS AND GAUGES

NOTE

For an overview see “Meters and gauges” in the “0. Illustrated table of contents” section and see “Instrument and control layout” in the “0. Illustrated table of contents” section.

SPEEDOMETER

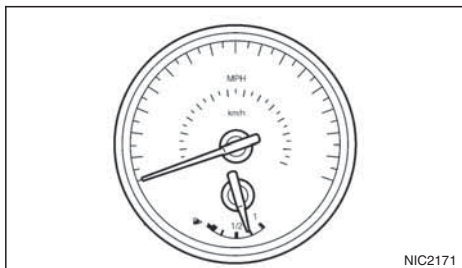

The speedometer indicates the vehicle speed. Scale resolution on the meter varies with models.

Odometer/twin trip odometer

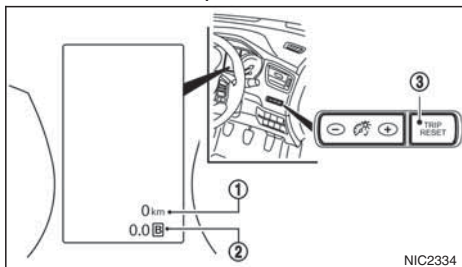

Right-Hand Drive (RHD) (for Left-Hand Drive (LHD) the layout will be opposite)

The odometer/twin trip odometer is displayed in the vehicle information display when the ignition switch is in the ON position.

The odometer ① displays the total distance the vehicle has been driven.

The twin trip odometer ② displays the distance of individual trips.

Changing twin trip odometer display:

Push the TRIP RESET switch ③ on the right or left side of the combination meter panel to change the display as follows:

TRIP A → TRIP B → ODO → TRIP A

Resetting twin trip odometer:

Push the TRIP RESET switch ③ for more than 1 second to reset the trip odometer to zero.

FUEL GAUGE

The fuel gauge is active when the ignition switch is in the ON position.

The gauge may move slightly during braking, turning, acceleration, or when going uphill or downhill.

The  symbol indicates that the fuel filler lid is located on the right side of the vehicle.

NOTE

A low fuel warning comes on in the vehicle information display when the fuel level is getting low. Refuel as soon as it is convenient. There should be a small reserve of fuel in the tank when the fuel gauge needle reaches the empty level.

The available range or distance to empty is permanently shown at the bottom of the vehicle information display, see “3. [Range] (dte — km or mile)” later in this section.

CAUTION

Refill the fuel tank before the range displays “0”, or “---”, and the gauge registers empty.

TACHOMETER

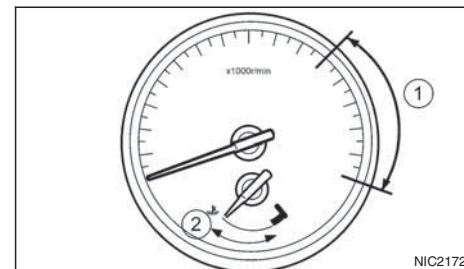

The tachometer indicates the engine speed in revolutions per minute. **Do not rev the engine into the red zone ①.**

Scale resolution on the meter varies with models.

CAUTION

When the engine speed approaches the red zone, shift to a higher gear. Operating the engine in the red zone may cause serious engine damage.

ENGINE COOLANT TEMPERATURE GAUGE

The gauge indicates the engine coolant temperature. The engine coolant temperature should remain within the normal range ②.

The engine coolant temperature varies with the outside air temperature and driving conditions.

CAUTION

If the gauge exceeds the normal range, stop as soon as it is safely possible. If the engine has overheated, continued operation of the vehicle may seriously damage the engine. See “Engine overheat” in the “6. In case of emergency” section for immediate action.



WARNING

Allow the engine to cool down before removing the radiator cap to avoid the danger of being scalded.

INSTRUMENT PANEL BRIGHTNESS CONTROL

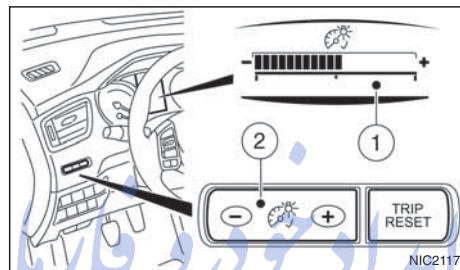

LHD (Left Hand Drive)

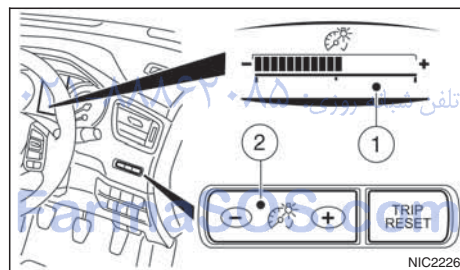

RHD (Right Hand Drive)





























The instrument brightness control switch can be operated when the ignition switch is in the ON position. When the switch is operated, the brightness adjustment mode appears at the bottom of the vehicle information display.

Push the + side of the switch ② to brighten the meter panel lights and instrument panel lights. The bar ① moves to the + side.

Push the - side of the switch ② to dim the lights. The bar ① moves to the - side.

When the instrument brightness control is not operated for a few seconds the brightness adjustment mode no longer appears.

WARNING/INDICATOR LIGHTS AND AUDIBLE REMINDERS

	Anti-lock Braking System (ABS) warning light		Seat belt (driver and front passenger) warning light		Front fog light indicator light
	Brake warning light (red)		Supplemental Restraint System (SRS) air bag warning light		Glow plug indicator light* (Diesel engine)
	Charge warning light		Water in fuel filter warning light*		High beam assist indicator light*
	Forward Emergency Braking system warning light*		Front passenger air bag status light*		High beam indicator light
	Low tyre pressure warning light*		4WD mode indicator light (AUTO)*		Rear fog light indicator light*
	Malfunction warning light (red)*		4WD mode indicator light (LOCK)*		Side light and headlight indicator light
	Malfunction indicator light (orange)		Dipped beam indicator light		Slip indicator light
	Master warning light		Door lock indicator light*		Trailer direction indicator light
	NATS security warning light		Electronic Stability Programme (ESP) OFF indicator light		Turn signal/hazard indicator lights
	Parking brake warning light				
	Power steering warning light				

*: where fitted

CHECKING BULBS

With all doors closed, apply the parking brake, fasten the seat belts and turn the ignition switch to the ON position without starting the engine.

The following lights (where fitted) come on briefly and then go off:



If any light fails to come on, it may indicate a burned-out bulb or an open circuit in the electrical system.

Have the system checked, and repaired promptly by a NISSAN dealer or qualified workshop.

Some indicators and warnings are also displayed in the vehicle informational display between the speedometer and tachometer see "Vehicle information display" later in this section.

WARNING LIGHTS

Also see “Vehicle information display” later in this section.



Anti-lock Braking System (ABS) warning light

When the ignition switch is in the ON position, the Anti-lock Braking System (ABS) warning light illuminates and then turns off. This indicates the ABS is operational.

If the ABS warning light illuminates while the engine is running, or while driving, it may indicate the ABS is not functioning properly. Have the system checked by a NISSAN dealer or qualified workshop.

If an ABS malfunction occurs, the anti-lock function is turned off. The brake system then operates normally, but without anti-lock assistance (see “Brake system” in the “5. Starting and driving” section).



BRAKE warning light (red)

When the ignition switch is placed in the ON position, the light remains illuminated for a few seconds. If the light illuminates at any other time, it may indicate that the brake system is not functioning properly. If the BRAKE warning light illuminates, stop the vehicle immediately and contact a NISSAN dealer or qualified workshop.

Low brake fluid warning light:

When the ignition switch is in the ON position, the light warns of a low brake fluid level. If this warning light illuminates, the Electronic Stability Programme

(ESP) warning light and the brake system warning light (yellow) also illuminate. If the light illuminates while the ignition switch is in the ON position with the parking brake not applied, stop the vehicle and perform the following steps:

1. Check the brake fluid level. If brake fluid level is low, add fluid and have the system checked by a NISSAN dealer or qualified workshop. See “Brake and clutch fluid” in the “8. Maintenance and do-it-yourself” section.
2. If the brake fluid level is correct, have the warning system checked by a NISSAN dealer or qualified workshop.



WARNING

- **Your brake system may not be working properly if the warning light is on. Driving could be dangerous. If you judge the brake system to be safe, drive carefully to the nearest service station for repairs. Otherwise, have your vehicle towed because driving it could be dangerous.**
- **Pressing the brake pedal when the ignition switch is not in the ON position and/or when the brake fluid level is low may increase the stopping distance and braking will require greater pedal effort as well as pedal travel.**
- **If the brake fluid level is below the minimum or MIN mark on the brake fluid reservoir, do not drive until the brake system has been checked at a NISSAN dealer or qualified workshop.**



Charge warning light

When the ignition switch is in the ON position, the charge warning light illuminates. After starting the engine, the charge warning light turns off. This indicates that the charging system is operational.

If the charge warning light illuminates while the engine is running, or while driving, it may indicate that the charging system is not functioning properly and may need servicing.

When the charge warning light illuminates while driving, stop the vehicle safely as soon as possible. Stop the engine and check the alternator belt. If the alternator belt is loose, broken or missing, the charging system needs repair (see “Drive belts” in the “8. Maintenance and do-it-yourself” section).

If the alternator belt appears to be functioning correctly but the charge warning light remains illuminated, have the charging system checked by a NISSAN dealer or qualified workshop promptly.

CAUTION

Do not continue driving if the alternator belt is loose, broken or missing.



Forward Emergency Braking system warning light (where fitted)

This light illuminates when the Forward Emergency Braking system is set to OFF on the lower display.

If the light illuminates when the Forward Emergency Braking system is ON, it may indicate that the sys-

tem is unavailable. See "Forward emergency braking system (where fitted)" in the "5. Starting and driving" section for more details.



Low tyre pressure warning light (where fitted)

Your vehicle is equipped with a Tyre Pressure Monitoring System (TPMS) that monitors the tyre pressure of all tyres except the spare.

The low tyre pressure warning light warns of low tyre pressure or indicates that the TPMS is not functioning properly.

After the ignition switch is placed in the ON position, this light illuminates for about 1 second and turns off.

Low tyre pressure warning:

If the vehicle is being driven with low tyre pressure, the warning light will illuminate. A low tyre pressure warning (e.g., [Low tyre pressure]) also appears in the vehicle information display.

When the low tyre pressure warning light illuminates, you should stop and adjust the tyre pressure of all 4 tyres to the recommended COLD tyre pressure shown on the tyre placard located on the driver side centre pillar see "Tyre placard" in the "9. Technical information" section. The low tyre pressure warning light does not automatically turn off when the tyre pressure is adjusted. After the tyre is inflated to the recommended pressure, the vehicle must be driven at speeds above 25 km/h (16 MPH) to activate the

TPMS and turn off the low tyre pressure warning light. Use a tyre pressure gauge to check the tyre pressure.

The low tyre pressure (e.g., [Low tyre pressure]) warning appears each time the ignition switch is placed in the ON position as long as the low tyre pressure warning light remains illuminated.

For additional information, see "Vehicle information display" later in this section and "Tyre Pressure Monitoring System (TPMS)" later in this section.

TPMS resetting must be also performed after a tyre or a wheel is replaced, or the tyres are rotated.

Depending on a change in the outside temperature, the low tyre pressure warning light may illuminate even if the tyre pressure has been adjusted properly. Adjust the tyre pressure to the recommended COLD tyre pressure again when the tyres are cold, and reset the TPMS.

If the low tyre pressure warning light still continues to illuminate after the resetting operation, it may indicate that the TPMS is not functioning properly. Have the system checked by a NISSAN dealer or qualified workshop.

For additional information, see "Tyre Pressure Monitoring System (TPMS)" in the "5. Starting and driving" section and "Vehicle information display" later in this section.

TPMS malfunction:

If the TPMS is not functioning properly, the low tyre pressure warning light will flash for approximately 1 minute when the ignition switch is placed in the ON

position. The light will remain on after 1 minute. Have the system checked by a NISSAN dealer or qualified workshop. The low tyre pressure warning does not appear if the low tyre pressure warning light illuminates to indicate a TPMS malfunction.

For additional information, see "Tyre Pressure Monitoring System (TPMS)" in the "5. Starting and driving" section.



WARNING

- **Radio waves could adversely affect electric medical equipment.** Those who use a pacemaker should contact the electric medical equipment manufacturer for the possible influences before use.
- **If the light does not illuminate with the ignition switch pushed ON, have the vehicle checked by a NISSAN dealer or qualified workshop as soon as possible.**
- **If the low tyre pressure warning light illuminates while driving, avoid sudden steering manoeuvres or abrupt braking, reduce vehicle speed, pull off the road to a safe location and stop the vehicle as soon as possible. Driving with under-inflated tyres may permanently damage the tyres and increase the likelihood of tyre failure. Serious vehicle damage could occur and may lead to an accident and could result in serious personal injury. Check the tyre pressure for all four tyres. Adjust the tyre pressure to the recommended COLD tyre pressure shown on the tyre placard, located**

on the driver side centre pillar, to turn the low tyre pressure warning light off. If the light still illuminates while driving after adjusting the tyre pressure, a tyre may be flat. If you have a flat tyre, repair it with the emergency tyre puncture repair kit (where fitted) or replace it with a spare tyre (where fitted) as soon as possible.

- After adjusting the tyre pressure, be sure to reset the TPMS. Unless the resetting is performed, the TPMS will not warn of the low tyre pressure correctly.
- When a spare tyre is mounted or a wheel is replaced, the TPMS will not function and the low tyre pressure warning light will flash for approximately 1 minute. The light will remain on after 1 minute. Contact a NISSAN dealer or qualified workshop as soon as possible for tyre replacement and/or system resetting.
- Replacing tyres with those not originally specified by NISSAN could affect the proper operation of the TPMS.

CAUTION

- The TPMS is not a substitute for the regular tyre pressure check. Be sure to check the tyre pressure regularly.
- If the vehicle is being driven at speeds of less than 25 km/h (16 MPH), the TPMS may not operate correctly.
- Be sure to install the specified size of tyres to all four wheels correctly.



Malfunction warning light (red) (where fitted)

When the ignition switch is turned to the ON position, the malfunction warning light illuminates. This means the system is operational.

See “Malfunction Indicator light (orange)” later in this section for details of the orange Malfunction Indicator light.

If the red malfunction warning light comes on steady while the engine is running, it may indicate an engine control system malfunction.

Have your vehicle inspected by a NISSAN dealer or qualified workshop. You do not need to have your vehicle towed to the dealer.

CAUTION

Continued vehicle operation without having the engine control system checked and repaired as necessary could lead to poor driveability, reduced fuel economy and possible damage to the engine control system, which may affect your warranty coverage.

Incorrect setting of the engine control system may lead to non-compliance of local and national emission laws and regulations.



Master warning light

When the ignition switch is in the ON position, the master warning light illuminates if any of the following are displayed in the vehicle information display (see “Vehicle information display” later in this section):

- No key warning
- Key ID incorrect warning
- Low windscreen washer fluid warning
- Parking brake release warning
- Door/boot open warning
- Low tyre pressure warning
- Four-Wheel Drive (4WD) warning (where fitted)
- Intelligent Key system warning

If the driver assist system warnings (where fitted) appear in the vehicle information display, the master warning light also illuminates. See “Blind Spot Warning (BSW) system (where fitted)” in the “5. Starting and driving” section, “Lane Departure Warning (LDW) system (where fitted)” in the “5. Starting and driving” section, and/or “Forward emergency braking system (where fitted)” in the “5. Starting and driving” section.



NATS security warning light

This light blinks when the ignition switch is in the LOCK, "OFF" or Acc position. This function indicates that your vehicle is equipped with the NISSAN Anti-Theft System (NATS)*.

If NATS is malfunctioning, this light will remain on while the ignition switch is in the ON position.

For additional information, see "Security system" later in this section.

* Immobilizer



Parking brake warning light

	Meter				Switch	
	Indicator	Warning light	Master warning light	Display text	Buzzer	LED
Parking brake applied		—	—	—	—	LED
Dynamic parking brake		Warning light ON	—	Release parking brake	Beep	LED
System failure	Depends on status	—		—	—	—
Parking brake switch pressed without brake pedal pressed		—	—	Press brake pedal	—	LED
Parking brake cannot be released automatically		—	—	Release parking brake	—	LED
Parking brake malfunction	 Flashing	—		—	—	LED Flashing

When the ignition switch is placed in the ON position, the indicator light in the meter comes on (red) when the parking brake is applied.

When the parking brake warning, light in the meter, and the LED (Light Emitting Diode), on the switch, flash this may indicate a malfunction.

Low brake fluid warning light:

When the ignition switch is in the ON position, the light warns of a low brake fluid level. If this warning light illuminates, the Electronic Stability Programme (ESP) warning light and the brake system warning light (yellow) also illuminate. If the light illuminates while the ignition switch is in the ON position with the parking brake not applied, stop the vehicle and perform the following steps:

1. Check the brake fluid level. If brake fluid level is low, add fluid and have the system checked by a NISSAN dealer or qualified workshop. See "Brake and clutch fluid" in the "8. Maintenance and do-it-yourself" section.
2. If the brake fluid level is correct, have the warning system checked by a NISSAN dealer or qualified workshop.



WARNING

- Your brake system may not be working properly if the warning light is on. Driving could be dangerous. If you judge the brake system to be safe, drive carefully to the nearest service station for repairs. Otherwise, have your vehicle towed because driving it could be dangerous.
- Pressing the brake pedal when the ignition switch is not in the ON position and/or when the brake fluid level is low may increase the stopping distance and braking will require greater pedal effort as well as pedal travel.

- If the brake fluid level is below the minimum or MIN mark on the brake fluid reservoir, do not drive until the brake system has been checked at a NISSAN dealer or qualified workshop.

For further parking brake operation information see "Parking brake switch" in the "8. Pre-driving checks and adjustments" section.



Power steering warning light



WARNING

- If the engine is not running or is turned off while driving, the power assist for the steering will not work. Steering will be harder to operate.
- When the power steering warning light illuminates with the engine running, there will be no power assist for the steering. You will still have control of the vehicle but the steering will be harder to operate. Have the power steering system checked by a NISSAN dealer or qualified workshop.

When the ignition switch is placed in the ON position, the power steering warning light illuminates. After starting the engine, the power steering warning light turns off. This indicates that the electric power steering system is operational.

If the power steering warning light illuminates while the engine is running, it may indicate the power steering system is not functioning properly and may

need servicing. Have the electric power steering system checked by a NISSAN dealer or qualified workshop. See "Electric power steering system" in the "5. Starting and driving" section.



Seat belt (driver and front passenger) warning light

The seat belt warning light reminds you to fasten your seat belts. The light illuminates whenever the ignition switch is placed in the ON or START position and remains illuminated until the driver's and/or front passenger's seat belt is fastened. At the same time, the chime sounds for about 6 seconds unless the driver's and/or front passenger's seat belt is securely fastened see "Seat belt reminder chime" later in this section. The seat belt warning light may also illuminate if the front passenger's seat belt is not fastened when the front passenger's seat is occupied. For 7 seconds after the ignition switch is placed in the ON position, the system does not activate the warning light for the front passenger. See "Seat belts" in the "1. Safety — Seats, Seat belts and Supplemental Restraint System" section for precautions on seat belt usage.



Supplemental Restraint System (SRS) air bag warning light



WARNING

If the supplemental air bag warning light is on, it could mean that the front air bag, side air bag (where fitted), curtain air bag (where fitted) and/or pre-tensioner systems will not operate in an

accident. To help avoid injury to yourself or others, have your vehicle checked by a NISSAN dealer or qualified workshop as soon as possible.

When the ignition switch is in the ON or START position, the Supplemental Restraint System (SRS) air bag warning light illuminates for approximately 7 seconds and then turns off this indicates the system is operational.

If any of the following conditions occur, the air bag systems and pre-tensioner systems need servicing and the vehicle must be taken to a NISSAN dealer or qualified workshop:

- The supplemental air bag warning light remains on after approximately 7 seconds.
- The supplemental air bag warning light flashes intermittently.
- The supplemental air bag warning light does not come on at all.

Unless checked and repaired, the SRS air bag system and/or the pre-tensioner seat belt system may not function properly.

For additional details see "SRS air bag warning light" in the "1. Safety — Seats, Seat belts and Supplemental Restraint System" section.



Water in fuel filter warning light (where fitted)

If the warning light remains on or flashes irregularly while the engine is running, there may be water in the fuel filter. Should this happen, contact a NISSAN dealer or qualified workshop.

CAUTION

Failure to drain the water from the fuel filter can cause serious damage to the engine. Contact a NISSAN dealer or qualified workshop as soon as possible.



Front passenger air bag status light (where fitted)

The front passenger air bag status light (OFF) located on the centre console above the shift lever will illuminate when the front passenger air bag is turned OFF with the front passenger air bag switch. When the front passenger air bag is turned on, the front passenger air bag status light ON (ON) will illuminate.

For more details, see "Front passenger air bag status light (where fitted)" in the "1. Safety — Seats, Seat belts and Supplemental Restraint System" section.

INDICATOR LIGHTS



Four-Wheel Drive (4WD) AUTO indicator light (4WD models)

When the ignition switch is placed in the ON position, the Four-Wheel Drive (4WD) AUTO indicator light illuminates and then turns off.

When selecting 4WD AUTO mode while the engine is running, the 4WD AUTO indicator light illuminates. See "Four-wheel Drive (4WD) (where fitted)" in the "5. Starting and driving" section.



4WD mode indicator light (LOCK) (4WD models)

When the ignition switch is placed in the "ON" position, the Four-Wheel Drive (4WD) LOCK indicator light illuminates and then turns off. When selecting 4WD LOCK mode while the engine is running, the 4WD LOCK indicator light illuminates together with the 4WD AUTO indicator light.

See "Four-wheel Drive (4WD) (where fitted)" in the "5. Starting and driving" section.



Dipped beam indicator light

This light comes on when the switch is turned to the position:  The headlights will come on and front side, tail, number plate and instrument lights remain on.



Door lock indicator light (where fitted)

The door lock indicator light located on the instrument panel illuminates when all the doors are locked while the ignition switch is in the ON position.

- When the doors are locked with the power door lock switch, the door lock indicator light will illuminate for 30 minutes.
- When the doors are locked by pushing the LOCK button on the Intelligent Key or any request switch (where fitted), the door lock indicator light will illuminate for 1 minute.
- The door lock indicator light turns off when any door is unlocked.

For locking or unlocking doors, see "Door locks" in the "3. Pre-driving checks and adjustments" section.



Electronic Stability Programme (ESP) OFF indicator light (where fitted)

The light comes on when the Electronic Stability Programme (ESP) OFF switch is pushed to the OFF position. This indicates that the ESP system is not operating.

This light also comes on briefly when the ignition switch is turned to the ON position. The light will turn off after approximately 1 second if the ESP system is operational.

When the ESP OFF indicator light and SLIP indica-

tor light (see "SLIP indicator light (where fitted)" later in this section) come on with the ESP system turned on, it alerts the driver to the fact that the system's fail-safe mode is operating. This means that the system may not be functioning properly. Have the system checked by your NISSAN dealer or qualified workshop.

If an abnormality occurs in the system, the ESP system function will be cancelled, but the vehicle is still driveable. For additional information, see "Electronic Stability Programme (ESP) system (where fitted)" in the "5. Starting and driving" section.



Front fog light indicator light

The light comes on when the front fog lights are switched on (see "Fog light switch" later in this section).



Glow plug indicator light (Diesel engines)

This light comes on when the ignition switch is in the ON position and goes out when the glow plugs have been pre-heated. When the engine is cold, the glow plug warm-up time will be longer.



High beam assist indicator light (where fitted)

The indicator light illuminates when the headlights come on while the headlight switch is in the AUTO position with the high beam selected. This indicates that the high beam assist system is operational. (See 2-36.)



High beam indicator light

This light comes on when the headlight high beam is on and goes out when the low beam is selected.



Malfunction Indicator light (orange)

When the ignition switch is turned to the ON position, the orange Malfunction Indicator light illuminates. This means that the system is operational.

If the orange Malfunction Indicator light comes on steady or blinks (where fitted) while the engine is running, it may indicate an engine control system malfunction.

See "Malfunction warning light (red) (where fitted)" earlier in this section for details of the red malfunction warning light (where fitted).

On steady (orange):

An engine malfunction has been detected. Have the vehicle inspected by a NISSAN dealer or qualified workshop. You do not need to have your vehicle towed to the dealer.

Blinking (orange) (where fitted):

An engine misfire has been detected which may damage the engine control system.

To reduce or avoid engine control system damage:

- Do not drive at speeds above 70 km/h (43 MPH).
- Avoid hard acceleration or deceleration.

- Avoid steep uphill grades.
- If possible, reduce the load being carried or towed.

The Malfunction Indicator light may stop blinking and come on steady.

Have the vehicle inspected by a NISSAN dealer or qualified workshop. You do not need to have your vehicle towed to the dealer.

CAUTION

Continued vehicle operation without having the engine control system checked and repaired as necessary could lead to poor driveability, reduced fuel economy and possible damage to the engine control system, which may affect your warranty coverage.



Rear fog light indicator light (where fitted)

The light comes on when the rear fog light is switched on (see “Rear fog light (where fitted)” later in this section).



Side light and headlight indicator light

This light comes on when the side light or headlight position is selected, see “Headlight and turn signal switch” later in this section for further details.



SLIP indicator light (where fitted)

The SLIP indicator blinks when the Electronic Stability Programme (ESP) system is operating, thus alerting the driver to the fact that the road surface is slippery and the vehicle is nearing its traction limits.

You may feel or hear the system working, this is normal.

The light will continue to blink for a few seconds after the ESP system stops limiting wheel spin.

For additional information see “Electronic Stability Programme (ESP) OFF indicator light (where fitted)” earlier in this section and “Electronic Stability Programme (ESP) system (where fitted)” in the “5. Starting and driving” section.



Trailer direction indicator light

The light will light up whenever an additional electrical load is detected by the direction indicator system.

For additional information, see “Trailer towing” in the “5. Starting and driving” section.



Turn signal/hazard indicator lights

The direction indicator lights will flash when the turn signal switch or hazard warning flasher switch is turned on. See “Headlight and turn signal switch” later in this section and see “Hazard warning flasher switch” in the “6. In case of emergency” section for further details.

AUDIBLE REMINDERS

Door open reminder chime

The chime will sound if any door other than the driver’s door is left open and the power door lock switch is held down.

Intelligent Key models: The external buzzer will sound if the vehicle is being locked remotely or using an outside door lock switch and any door is open.

Parking brake reminder buzzer

A buzzer will sound when driving away if the parking brake has not been released. Stop the vehicle and release the parking brake.

Light reminder chime

A chime will sound for 10 seconds if the driver’s door is opened while the external lights are turned on and the ignition switch is in the “OFF” or LOCK position.

See “Headlight and turn signal switch” later in this section for further details on the headlight operation.

Fog light reminder chime

A chime will sound if the ignition switch is in the “OFF” or LOCK position and the headlight switch is in the AUTO position (where fitted) and the fog lights are left on.

See “Fog light switch” later in this section for further details.

Seat belt reminder chime

A chime will sound for approximately 90 seconds if the vehicle's speed exceeds 15 km/h (9 MPH) and the driver's seat belt or front passenger's seat belt, if occupied (where fitted) is not securely fastened. See "Seat belt warnings" in the "1. Safety — Seats, Seat belts and Supplemental Restraint System" section.

Key reminder buzzer (Intelligent Key models)

The external buzzer will beep 3 times if:

- The Intelligent Key is removed from the vehicle while the ignition is not in the LOCK position.
- The vehicle is being locked remotely or using an outside door lock switch and the Intelligent Key has been left inside the vehicle.

Park reminder chime (where fitted)

A chime will sound if the ignition switch is placed in the LOCK position and the shift lever is not in the P (Park) position.

Stop/Start System reminder buzzer (where fitted)

The engine will shift to the normal stopped state if any of the following operations is made during Stop/Start System activation, and the Stop/Start System buzzer will sound if:

- The driver's seat belt is unfastened and the driver's door is open (MT models)

- The vehicle engine bonnet is open.

When any of the above conditions continues for over 3 minutes the Stop/Start System buzzer will sound in 5-minute intervals as a reminder to prevent the possibility of a dead battery. Use the ignition switch to turn off the engine.

Close the bonnet or the driver's door, or fasten the seat belt then restart the engine using the ignition switch.

For more information, see "[Stop/Start]" in the "5. Instruments and controls" section and "Stop/Start System (where fitted)" in the "5. Starting and driving" section.

تلفن شبانه روزی: ۰۲۱-۸۸۶۲۰۸۵

FarmaSOS.com

VEHICLE INFORMATION DISPLAY

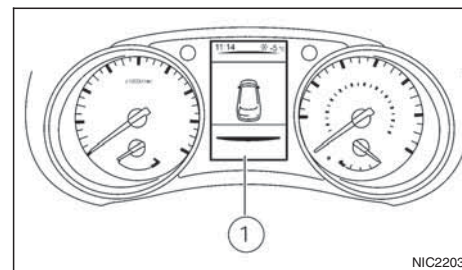

The vehicle information display ① is located between the tachometer and the speedometer, and it displays such items as:

- Vehicle settings
- Trip computer information
- Drive system warnings and settings (where fitted)
- Cruise control system information
- NISSAN Intelligent Key operation information
- Chassis Control
- Indicators and warnings (where fitted)
- Tyre Pressure information

HOW TO USE THE VEHICLE INFORMATION DISPLAY

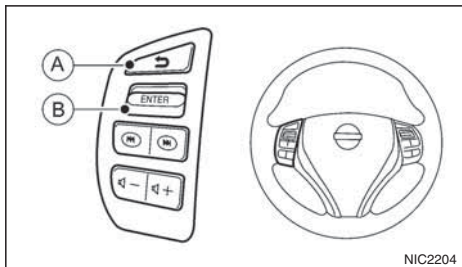





The vehicle information display can be changed using the ENTER and BACK buttons located on the left side of the steering wheel.

Back button

Press the BACK button to return to the previous display screen or menu level, or to cancel the selection if it is not completed.

or Display scrolling switch

Push  or  to scroll through the items in the vehicle information display. Press ENTER to select an item in the display, then push  or  to scroll through the associated menu options.

STARTUP DISPLAY

When the ignition is placed in the ON or ACC position the screens displayed include:

- Active system status (where fitted)
- Trip computer
- Tyre pressure information
- Fuel economy
- Warnings
- Outside air temperature
- Odometer/Twin Trip Odometer

Warnings will only display if there are any present, for more information on warnings and indicators, see “Vehicle information display warnings and indicators” later in this section. To control which items display in the vehicle information display, see “Settings” later in this section.



SETTINGS

The setting mode allows you to change the information displayed in the vehicle information display:

- [Driver Assistance]
- [Clock]
- [Display Settings]
- [Vehicle Settings]
- [Maintenance]
- [Alert]

- [Tyre Pressures]
- [Units]
- [Language]
- [Factory reset]

[Driver assistance]

Use the  or  switches and the ENTER button to change the status, warnings or turn on or off any of the systems/warnings displayed in the [Driver Assistance] menu. The following menu options are available:

- [Driving Aids] (where fitted)
- [Driver Attention] (where fitted)
- [Traffic Sign] (where fitted)
- [Parking Aids]
- [Chassis control]:

this allows you to turn [Trace Control] and [Engine Brake] on or off.

- [Trace Control]:
(For more information, see “Active trace control” in the “5. Starting and driving” section)
- [Engine Brake]:
(For more information, see “Active engine brake (for XTRONIC (CVT) models only)” in the “5. Starting and driving” section)

- [Steering effort]: this can be set to [Normal] or [Sport].

The [Driving Aids] option has a sub-menu, from which you can choose whether or not to have further items displayed. These items are:

- [Lane] (Lane Departure Warning system)
- [Blind Spot] Blind Spot Warning system)
- [Emergency Brake] (Forward Emergency Brake system)

The [Driver Attention] option can be used to activate or deactivate the Driver Attention Support feature (where fitted). This system is able to detect whether the driver is displaying a lack of attention, or is distracted. It does this by monitoring driving style, and steering behaviour, and it notes deviations from the normal pattern. If the system detects that driver attention is decreasing, the system uses an audible and visual warning to suggest that the driver takes a break.

[Clock]

For details of how to set the clock, see “Setting the clock” in the “4. Display screen, heater and air conditioner, and audio system” section or the separate NissanConnect Owner’s manual.

[Display settings]

Use the ▲ or ▼ switches to scroll and the ENTER button to change the status, warnings or turn on or off any of the systems/warnings displayed in the [Display Settings] menu. The following menu options are available:

- [Contents selection]
- [Body Colour]
- [ECO Mode Settings] (where fitted)
- [Stop/Start]
- [ECO Drive Report]
- [Welcome Effect]

[Contents selection]:

The items that display when the ignition switch is placed in the ON position can be enabled/disabled. To change the items that are displayed, use the ▲ or ▼ buttons to scroll and the ENTER button to select a menu item: The following items (where fitted) are available in the [Meter Settings] menu:

- [Home]
- [Average speed]
- [Trip]
- [Fuel economy]
- [Navigation] (where fitted)
- [Traffic Sign] (where fitted)
- [Audio]

- [Driving aids] (where fitted)
- [Tyre pressures]
- [Driver Attention] (where fitted)
- [Chassis control]

The [Driving Aids] option has a sub-menu, from which you can choose whether or not to have further items displayed. These items are:

- [Lane] (Lane Departure Warning system)
- [Blind Spot] Blind Spot Warning system)
- [Emergency Brake] (Forward Emergency Braking system)

[Body Colour]:

The colour of the vehicle that displays in the vehicle information display when the ignition switch is placed in the ON position can be changed.

[ECO mode settings] (where fitted):

You can choose which of the ECO mode features you wish to see displayed. These include the ECO indicator ([ECO glow]), and from the Display sub-menu, the [Pedal Guide] and Instant fuel economy ([Fuel econ.]) display.

[Stop/Start]:

The [Stop/Start] system mode shows the CO₂ savings and the engine stop time. (See “Stop/Start System (where fitted)” in the “5. Starting and driving” section.)

The following options are available in the [Stop/Start] menu:

- [Display]:
You can choose whether on not to display stop/start information.
- [Trip CO2 saving]:
The [Trip CO2 saving] and engine stop time mode shows the CO2 saving and engine stop time since the last reset. The CO2 saving and engine stop time can be reset by pushing ENTER for longer than 1 second.
- [Total CO2 saving]:
The [Total CO2 saving] and engine stop time mode shows:
 - The estimated CO2 exhaust emissions prevented.
 - The engine stop time that the engine has been stopped by the [Stop/Start] System

NOTE

The [Total CO2 saving] and engine stop time values cannot be reset and show accumulated [Stop/Start] System information since the vehicle was built.

[ECO Drive Report]:

You can choose whether or not to display ECO information in the vehicle information display when the ignition switch is placed in the ON position.

From the Main Menu Selection select [ECO Drive Report] to display the information when the ignition switch is placed in the ON position.

Select [Display] then On or Off to display the information when the ignition switch is placed in the ON position. The ECO Drive Report is displayed when the ignition switch is in the OFF position.

You can also view the ECO drive report history.

[Welcome Effect]:

You can choose whether or not to display the welcome screen when the ignition switch is placed in the ACC (where fitted) or ON position. You can also choose the following items to define how the welcome screen looks:

- [Dial and pointer]
- [Display effect]

To enable/disable the welcome screen, and set how it appears:

1. Use the ▲ or ▼ buttons to select [Settings], and press ENTER.
2. Select [Welcome Effects] using the ▲ or ▼ buttons and press ENTER to select this menu. Use the ▲ or ▼ buttons to navigate between the menu options and press ENTER to turn each function ON or OFF.

[Vehicle settings]

Use the ▲ or ▼ switches and the ENTER button to change the status, warnings or turn on or off any of the systems/warnings displayed in the [Vehicle set-

tings] menu. The following menu options, each leading to a further sub-menu, are available:

- [Lighting]
- [Turn indicator]
- [Unlocking]
- [Wipers]

[Lighting]:

The [Lighting] menu has the following options:

- [Welcome light]:
The welcome lighting can be set to be ON or OFF. From the [Lighting] menu, select [Welcome Light]. Use the ENTER button to turn this feature ON or OFF. When set to ON, front and rear lamps will stay on for 30 seconds after unlocking. They will also stay on for 10 seconds after locking.
- [Int. Lamp timer]:
The internal light timer can be set to be ON or OFF. From the [Lighting] menu, select [Int. Lamp timer]. Use the ENTER button to turn this feature ON or OFF.
- [Mood lighting]:
The mood lighting can be dimmed or brightened. From the [Lighting] menu, select [Mood lighting]. Use the ENTER button and the ▲ or ▼ switches to adjust the brightness.

- [Auto lights]:
The sensitivity of the automatic lighting can be adjusted. From the [Lighting] menu, select [Auto Lights]. Use the ▲ or ▼ and ENTER switches to select the required sensitivity. The following options are available:

- On earliest
- On earlier
- Standard
- On later

[Turn indicator]:

The [3 flash on] overtaking feature can be set to be ON or OFF. From the Vehicle Settings menu, select “[3 Flash on]”. Use the ENTER button to turn this feature ON or OFF.

[Unlocking]:

There are two options (where fitted) in the [Unlocking] menu:

- [I-Key Door Lock] (where fitted)
When this item is turned on, the request switch on the door is activated. From the [Unlocking] menu, select [I-Key Door Unlock]. Use the ENTER button to activate or deactivate this function.
- [Selective unlock]
When this item is turned on, and the door handle request switch on the driver's or front passenger's side door is pushed, only the corresponding door is unlocked. All the doors can be unlocked if the door handle request switch is

pushed again within 1 minute. When this item is turned to off, all the doors will be unlocked when the door handle request switch is pushed once. From the [Unlocking] menu, select [Selective Unlock]. Use the ENTER button to activate or deactivate this function.

[Wipers]:

- [Speed dependent] (where fitted)
The Speed dependent wiper feature can be set to be ON or OFF. From the [Wipers] menu, select [Speed Dependent]. Use the ENTER button to turn this feature ON or OFF.
- [Rain Sensor] (where fitted)
The [Rain sensor] feature can be activated or deactivated. From the [Wipers] menu, select [Rain Sensor]. Use the ENTER button to turn this feature ON or OFF.
- [Reverse link]
The [Reverse link] wiper feature can be set to be ON or OFF. From the [Wipers] menu, select [Reverse Link]. Use the ENTER button to turn this feature ON or OFF.
- [Drip wipe]
The [Drip wipe] feature can be set to be ON or OFF. From the [Wipers] menu, select [Drip Wipe]. Use the ENTER button to turn this feature ON or OFF.

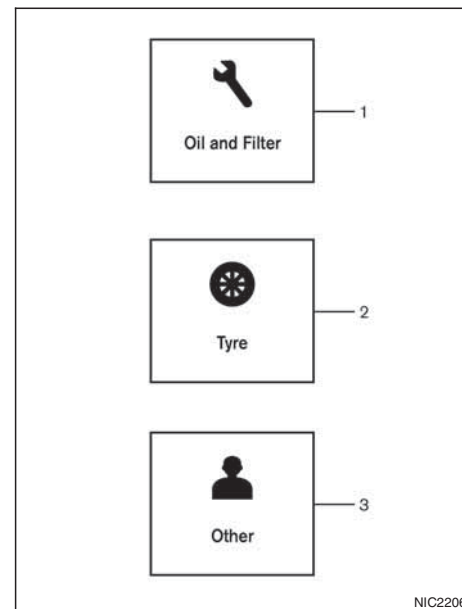

Maintenance

1. Engine oil and filter replacement indicator:

This indicator appears when the customer set time comes for changing the engine oil and filter. You can set or reset the distance for changing the engine oil and filter.

NOTE

Diesel models with diesel engines make use of an Oil Condition Supervisor (OCS) function. Petrol engines have a basic service reminder.

1. Use the ▲ or ▼ buttons to select [Settings], and press ENTER.
2. Select [Maintenance], followed by [Service] using the ▲ or ▼ and ENTER switches. In the [Service] menu, use the ▲ or ▼ buttons to navigate between the menu options and press ENTER to set or reset the distance for changing the engine oil.
3. (Diesel models only) Select [Maintenance], followed by [Filter] using the ▲ or ▼ and ENTER switches. In the [Filter] menu, use the ▲ or ▼ buttons to navigate between the menu options and press ENTER to set or reset the distance for draining the diesel fuel filter.

For scheduled maintenance items and intervals, see your NISSAN Service and Maintenance Guide.

2. Tyre replacement indicator:

This indicator appears when the customer set distance comes for replacing tyres. You can set or reset the distance for replacing tyres.

1. Use the ▲ or ▼ buttons to select [Settings], and press ENTER.
2. Select [Maintenance], followed by [Tyre] using the ▲ or ▼ and ENTER switches. In the [Tyre]

menu, use the ▲ or ▼ buttons to navigate between the menu options and press ENTER to set or reset the distance for replacing tyres.



WARNING

The tyre replacement indicator is not a substitute for regular tyre checks, including tyre pressure checks. See “Wheels and tyres” in the “8. Maintenance and do-it-yourself” section. Many factors including tyre inflation, alignment, driving habits and road conditions affect tyre wear and when tyres should be replaced. Setting the tyre replacement indicator for a certain driving distance does not mean your tyres will last that long. Use the tyre replacement indicator as a guide only and always perform regular tyre checks. Failure to perform regular tyre checks, including tyre pressure checks could result in tyre failure. Serious vehicle damage could occur and may lead to a collision, which could result in serious personal injury or death.

3. Other indicator:

This indicator appears when the customer set time comes for replacing items other than the engine oil, fuel filter and tyres. You can set or reset the distance for replacing the items.

[Alert]

You can specify that an alert occurs to notify the driver that a certain event has occurred. You can set alerts for the following items:

- [Timer]

- [Navigation] (where fitted)
- [Phone]
- [Mail] (where fitted)

To set an alert:

1. Use the ▲ or ▼ buttons to select the item required, and press ENTER.
2. For [Phone], [Navigation] or [Mail] use the ENTER button to toggle between YES and NO. For the [Timer], to change the timer value, use the ▲ or ▼ buttons and the ENTER button to save the selected length of time.

[Tyre pressures]

The settings in the Tyre pressures] menu are all related to the Tyre pressure monitoring system TPMS (see “Tyre Pressure Monitoring System (TPMS)” in the “5. Starting and driving” section).

- [Target front]
- [Target rear]
- [Tyre pressure unit]
- [Calibrate]

[Target front]:

The [target front] tyre pressure is the pressure specified for the front tyres on the tyre placard (see “Tyre placard” in the “9. Technical information” section and “Tyre Pressure Monitoring System (TPMS)” in the “5. Starting and driving” section).

Use the ▲ or ▼ and the ENTER buttons to select and change the value for the [target front] tyre pressure.

[Target rear]:

The [target rear] tyre pressure is the pressure specified for the rear tyres on the tyre placard (see “Tyre placard” in the “9. Technical information” section and “Tyre Pressure Monitoring System (TPMS)” in the “5. Starting and driving” section).

Use the ▲ or ▼ and the ENTER buttons to select and change the value for the [target rear] tyre pressure.

[Tyre pressure unit]:

The unit for tyre pressure that displays in the vehicle information display can be changed to:

- Kgf/cm²
- kPa
- bar
- psi

Use the ▲ or ▼ and the ENTER buttons to select and change the unit.

Pressure units conversion table

kPa	200	210	220	230	240	250	260	270	280	290	300	310	320	330	340
psi	29	30	32	33	35	36	38	39	41	42	44	45	46	48	49
bar	2.0	2.1	2.2	2.3	2.4	2.5	2.6	2.7	2.8	2.9	3.0	3.1	3.2	3.3	3.4
kgf/cm ²	2.0	2.1	2.2	2.3	2.4	2.5	2.6	2.7	2.8	2.9	3.0	3.1	3.2	3.3	3.4

امداد خودرو فارما

تلفن شبانه روزی: ۰۲۱-۸۸۸۶۲۰۸۵

FarmaSOS.com

[Calibrate]:

The tyre pressure is affected by the temperature of the tyre; the tyre temperature increases when the vehicle is driven. The TPMS system uses temperature sensors in the tyres to compensate for changes in temperature in order to prevent false TPMS warnings.

The [CALIBRATE] function resets the previously stored temperature value. It is recommended that this function is performed after the tyre pressures are adjusted.

See "Tyre Pressure Monitoring System (TPMS)" in the "5. Starting and driving" section

Use the ▲ or ▼ and the ENTER buttons to start or cancel the calibration process. While the calibration process is active, the message: [Resetting tyre pressure system] will be displayed.

[Units]

- [Distance/Fuel]
- [Tyre pressures]
- [Temperature]

[Distance/Fuel]:

The unit for the distance and fuel consumption that displays in the vehicle information display can be changed to:

- miles, MPG
- km, km/l
- km, l/100km

Use the ▲ or ▼ and the ENTER buttons to select and change the unit.

[Tyre pressures]:

The unit for tyre pressure that displays in the vehicle information display can be changed to:

- Kgf/cm2
- kPa
- bar
- psi

Use the ▲ or ▼ and the ENTER buttons to select and change the unit.

[Temperature]:

The temperature that displays in the vehicle information display can be changed from:

- °C (Celsius)
- °F (Fahrenheit)

Use the ENTER button to toggle choices.

[Language]

The [language] of the vehicle information display can be changed to:

- [English]
- [French]
- [German]
- [Italian]
- [Portuguese]

- [Dutch]
- [Spanish]
- [Turkish]
- [Russian]



















Use the ▲ or ▼ and the ENTER buttons to select and change the language of the vehicle information display.

[Factory reset]

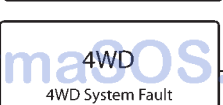
The settings in the vehicle information display can be reset back to the factory default. To reset the vehicle information display:

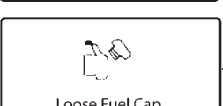
1. Use the ▲ or ▼ buttons to select [Settings], and press the ENTER button
2. Select [Factory Reset] using the ▲ or ▼ buttons and press the ENTER button
3. Select [YES] to return all settings back to default by pressing the ENTER button

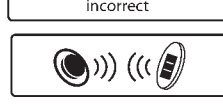
VEHICLE INFORMATION DISPLAY WARNINGS AND INDICATORS

 1	Release Parking Brake 8	Press Brake Pedal 15	4WD Tyre Size Incorrect See Owner's Manual 21	 29
 2	 Range 000 km 9	 Low Tyre Pressure 16	Shipping Mode On Push Storage Fuse 22	 30
No Key Detected 3	 Low washer fluid 10	 Low Oil Pressure Stop Vehicle 17	Power will turn off to save the battery 23	 31
Key System Fault 4	 11	 Oil level low 18	Power turned off to save the battery 24	Tyre pressure system fault 32
Key battery low 5	 Shift to Park 12	 4WD 4WD System Fault See Owner's Manual 19	 Reminder Turn OFF headlights 25	 Parking Sensor System Fault 34
Key ID incorrect 6	 Loose Fuel Cap 13	4WD 4WD High Temp. Stop Vehicle 20	 Time for a driver break? 26	 Vehicle overheating Stop vehicle 35
 7	Battery Charge Low Charge Battery 14		 Low Outside Temperature 27	 CVT CVT System Fault 36
			Chassis Control System Fault 28	Adaptive front-lighting system fault 37
				Headlight system fault 38

NIC2331

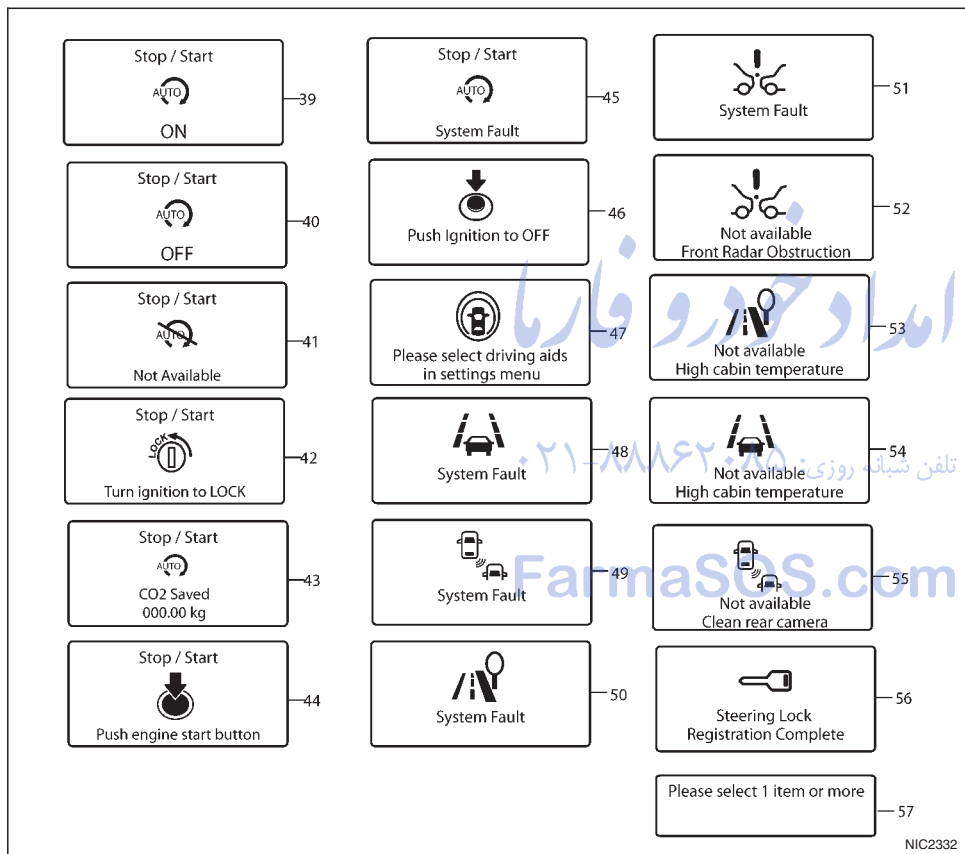

1. Engine start operation indicator (for XTRONIC transmission models)

This indicator appears when the shift lever is in the P (Park) position.

This indicator indicates that the engine will start by pushing the ignition switch with the brake pedal depressed.

2. Engine start operation indicator (for Manual Transmission (MT) models)

This indicator indicates that the engine will start by pushing the ignition switch with the clutch pedal depressed.

You can also start the engine by pushing the ignition switch with the brake pedal depressed when the shift lever is in the N (Neutral) position.

3. [NO KEY Detected] warning

The warning appears when the door is closed with the Intelligent Key left outside the vehicle and the ignition switch in the ACC or ON position. Make sure that the Intelligent Key is inside the vehicle.

See “Intelligent Key system (where fitted)” in the “3. Pre-driving checks and adjustments” section for more details.

4. [Key System Fault] warning

This warning appears if there is a malfunction in the Intelligent Key system.

If this warning appears while the engine is stopped, the engine cannot be started. If this warning appears while the engine is running, the vehicle can be driven. However, contact a NISSAN dealer or qualified workshop for repair as soon as possible.

5. [Key battery low] indicator

This indicator appears when the Intelligent Key battery is running out of power.

If this indicator appears, replace the battery with a new one. (See "Integrated keyfob/Intelligent Key battery replacement" in the "8. Maintenance and do-it-yourself" section.)

6. [Key ID Incorrect] warning

This warning appears when the ignition switch is pushed from the LOCK position and the Intelligent Key cannot be recognised by the system. You cannot start the engine with an unregistered key. Use the registered Intelligent Key. See "Intelligent Key system (where fitted)" in the "3. Pre-driving checks and adjustments" section.

7. Engine start operation for Intelligent Key system indicator

This indicator appears when the Intelligent Key battery is running out of power and the Intelligent Key system and vehicle are not communicating normally.

If this indicator appears, touch the ignition switch with the Intelligent Key while depressing the brake pedal. (See "Push-button ignition switch (where fitted)" in the "5. Starting and driving" section.)

8. [Release parking brake] warning

This warning appears when the vehicle speed is above 7 km/h (4 MPH) and the parking brake is applied. Stop the vehicle and release the parking brake. This warning may occur if the driver has attempted to release the parking brake automatically, but did not succeed.

9. Low fuel ([Range]) warning

This warning appears when the fuel level in the tank is getting low. Refuel as soon as it is convenient, preferably before the fuel gauge reaches the empty (0) position.

There is a small reserve of fuel remaining in the tank when the fuel gauge reaches the empty (0) position.

10. [Low washer fluid] warning تلفن شیشه

This warning appears when the washer tank fluid is at a low level. Add washer fluid as necessary. (See "Window washer fluid/headlight cleaner fluid (where fitted)" in the "8. Maintenance and do-it-yourself" section.)

11. Door/boot open warning

This warning appears if any of the doors and/or the boot lid are open or not closed securely. The vehicle icon indicates which door or whether the boot lid is open on the display.

12. [SHIFT to Park] warning (XTRONIC transmission models)

This warning appears when the ignition switch is pushed to stop the engine with the shift lever in any position except the P (Park) position.

If this warning appears, move the shift lever to the P (Park) position or place the ignition switch in the ON position.

An inside warning chime will also sound. (See "Push-button ignition switch (where fitted)" in the "5. Starting and driving" section.)

13. [Loose Fuel Cap] warning

This warning appears when the fuel-filler cap is not tightened correctly after the vehicle has been refuelled. See "Fuel filler lid" in the "3. Pre-driving checks and adjustments" section of this manual.

14. [Battery Voltage Low Charge Battery] warning

This warning appears when the battery voltage is low and the battery needs to be charged.

15. [Press Brake Pedal] warning

This warning appears to remind you that you must press the brake pedal before you can release the parking brake. This warning may also be displayed if the parking brake is activated, but the vehicle is still rolling back.

16. [Low Tyre Pressure] warning

This warning ([Low Tyre Pressure] and a vehicle icon - where fitted) appears when the low tyre pressure warning light in the meter illuminates and low tyre pressure is detected. The warning appears each time the ignition switch is placed in the ON position as long as the low tyre pressure warning light remains illuminated. If this warning appears, stop the vehicle and adjust the pressure to the recommended COLD tyre pressure shown on the tyre placard. (See "Low tyre pressure warning light (where fitted)" earlier in this section and "Tyre Pressure Monitoring System (TPMS)" in the "5. Starting and driving" section.)

17. [Low oil pressure stop vehicle] warning

This warning appears in message area of the vehicle information display if low oil pressure is detected. This gauge is not designed to indicate low oil level. The low oil pressure warning is not designed to indicate a low oil level. Use the dipstick to check the oil level. See "Engine oil" in the "8. Maintenance and do-it-yourself" section.)

CAUTION

The oil level should be checked regularly using the engine oil dipstick. Operating with an insufficient amount of oil can damage the engine and such damage is not covered by the warranty.

18. [Oil Level Low] warning

This warning appears in message area of the vehicle information display if the oil level is not sufficient for driving. Park the vehicle at a safe location as soon as possible and use the dipstick to check the oil level. See "Engine oil" in the "8. Maintenance and do-it-yourself" section. If the oil level is not sufficient for driving, top up the engine oil with the recommended engine oil. "Engine oil" in the "8. Maintenance and do-it-yourself" section.)

CAUTION

The oil level should be checked regularly using the engine oil dipstick. Operating with an insufficient amount of oil can damage the engine and such damage is not covered by the warranty.

19. [4WD System Fault] warning

This warning appears when the four wheel drive (4WD) system is not functioning properly while the engine is running.

20. [4WD high temp. stop vehicle] warning

This warning may appear while trying to free a stuck vehicle due to increased oil temperature. The driving mode may change to Two-Wheel Drive (2WD). If this warning is displayed, stop the vehicle with the engine idling, as soon as it is safe to do so. Then if the warning turns off, you can continue driving.

21. [4WD tyre size incorrect] warning

This warning may appear if there is a large difference between the diameters of the front and rear wheels and tyres. Pull off the road in a safe area, with the engine idling. Check that all the tyre sizes are the same, that tyre pressures are correct and that the tyres are not excessively worn.

22. [Shipping mode on push storage fuse] warning

This warning may appear if the extended storage fuse switch is not pushed in (switched on). When this warning appears, push in (switch on) the extended storage fuse switch to turn off the warning. For more information, see "Fuses" in the "8. Maintenance and do-it-yourself" section.

23. [Power will turn off to save the battery] warning

This warning appears after a period of time if the shift lever has not moved from the P (Park) position while the ignition is in the ON position for a certain period of time.

24. [Power turned off to save the battery] warning

This warning appears after the ignition switch is automatically turned OFF to save the battery.

25. [Reminder turn off headlights] warning

This warning appears when the driver side door is opened while the headlight switch is left ON and the ignition switch is placed in the ACC, "OFF" or LOCK position. Place the headlight switch in "OFF" or "AUTO" position. For additional information, see "Headlight and turn signal switch" later in this section.

26. [Time for a driver break?] indicator

This indicator appears when the set "TIMER" indicator activates. You can set the time for up to 6 hours.

27. [Low outside temperature] warning

This warning appears if the outside temperature is below 3°C (37°F). The warning can be set not to be displayed. (See "[Clock] and [outside air temperature]" later in this section or the separate NissanConnect Owner's manual.)

28. [Chassis control system fault] warning

This warning appears if the chassis control module detects an error in the Chassis Control System (where fitted). Have the system checked by a NISSAN dealer or qualified workshop. (See "Chassis control" in the "5. Starting and driving" section.)

29. Cruise control indicator

This indicator shows the cruise control system status. The status is shown by the colour.

See "Cruise control (where fitted)" in the "5. Starting and driving" section for details.

30. Speed limiter indicator

This indicator shows the status of the speed limiter system. If the system is turned on and in use, the speed that the speed limiter is set to is also displayed.

See "Speed limiter (where fitted)" in the "5. Starting and driving" section for details.

31. Shift lever position indicator

This indicator shows the shift lever position.

See "Shift lever indicator (where fitted)" in the "5. Starting and driving" section for further details.

32. [Tyre Pressure System Fault] warning

This warning illuminates when there is a problem with the Tyre Pressure Monitoring System (TPMS). If this warning comes on, have the system checked by a NISSAN dealer or qualified workshop. See "Tyre Pressure Monitoring System (TPMS)" in the "5. Starting and driving" section for further details.

33. [Resetting Tyre Pressure System] indicator

This warning illuminates when the TPMS temperature calibration is in progress. See "TPMS temperature calibration" in the "5. Starting and driving" section for further details.

34. [Parking Sensor System Fault] warning (where fitted)

This warning illuminates when there is a problem with the parking sensor system. If this warning comes on, have the system checked by a NISSAN dealer or qualified workshop.

35. [Vehicle Overheating Stop Vehicle] warning

This warning illuminates is the engine coolant temperature is too high, indicating that the engine is overheating. See "Engine overheat" in the "6. In case of emergency" section for further details.

36. [CVT System Fault] warning (where fitted)

This warning illuminates when there is a problem with the XTRONIC transmission (CVT) system. If this warning comes on, have the system checked by a NISSAN dealer or qualified workshop.

37. [Adaptive Front-Lighting System Fault] warning (where fitted)

This warning illuminates when there is a problem with the dynamic high beam assistant system. See “Dynamic high beam assistant (where fitted)” later in this section. If this warning comes on, have the system checked by a NISSAN dealer or qualified workshop.

38. [Headlight System Fault] warning (where fitted)

This warning illuminates when the LED headlights need to be replaced. If this warning comes on, have the system checked by a NISSAN dealer or qualified workshop. See “LED headlight (where fitted)” later in this section

39–45. [Stop/Start] System

These indicators show the Stop/Start System status. See “Stop/Start System (where fitted)” in the “5. Starting and driving” section.

46. [Push Ignition to OFF] warning

This warning will illuminate if the ignition switch is placed in the ACC position when the shift lever is moved to the P (Park) position. To turn off the Push warning, place the ignition switch in the ON position and then in the LOCK position.

47. [Please Select Driving Aids in Settings Menu] warning

This warning is displayed if the Driving Aids items are not available because they are turned off in the Settings menu.

48–51. [System Fault] warning

This warning appears when the Blind Spot Warning, (where fitted), Lane Departure Warning (where fitted), Traffic Sign Recognition (where fitted), or Forward Emergency Braking systems (where fitted) are not functioning properly.

52. [Not Available Front Radar Obstruction] warning (where fitted)

If the sensor area of the front bumper is covered with dirt or obstructed, making it impossible to detect a vehicle ahead, the forward emergency braking system is automatically turned off. The forward emergency braking system warning light (orange) and the forward collision warning light (orange) will illuminate and the [Not Available Front Radar Obstruction] warning message will appear in the vehicle information display. If the [Not Available Front Radar Obstruction] warning message appears, park the vehicle in a safe location and turn the engine off. Check to see if the sensor area of the front bumper is blocked. If the sensor area of the front bumper is blocked, remove the blocking material. Restart the engine. If the warning light continues to illuminate, have the forward emergency braking system checked by a NISSAN dealer or qualified workshop.

53–54. [Not Available High Cabin Temperature] warning (where fitted)

This warning appears if the interior temperature of the vehicle has reached such a high temperature that the sensor for the Traffic Sign Recognition and Lane Departure warning systems can no longer function reliably. Once the interior temperature has reached normal levels, the warning should disappear. If the warning continues to display, have the system checked by a NISSAN dealer or qualified workshop

55. [Not Available Clean Rear Camera] warning (where fitted)

This message is displayed if the rear camera used by the Blind Spot Warning system is dirty or covered with snow or rain. If the message appears, park the vehicle in a safe place, turn off the engine, and clean the camera unit with a soft cloth. Then restart the engine.

56. [Steering lock Registration Complete] indicator

This appears when a new intelligent key is registered to the vehicle.

57. [Please select 1 item or more] indicator

This message appears when you are in the main menu of the vehicle information display to remind you to select at least one item.

TRIP COMPUTER

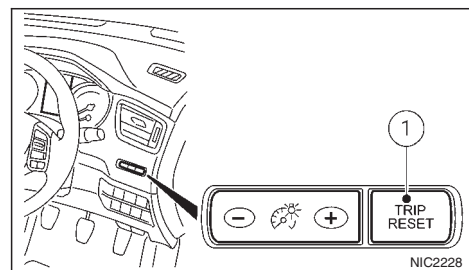
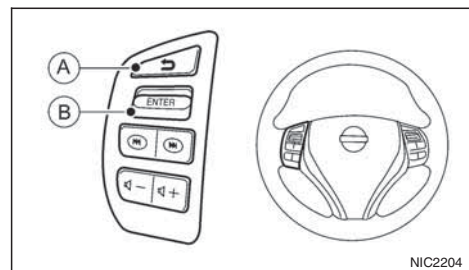
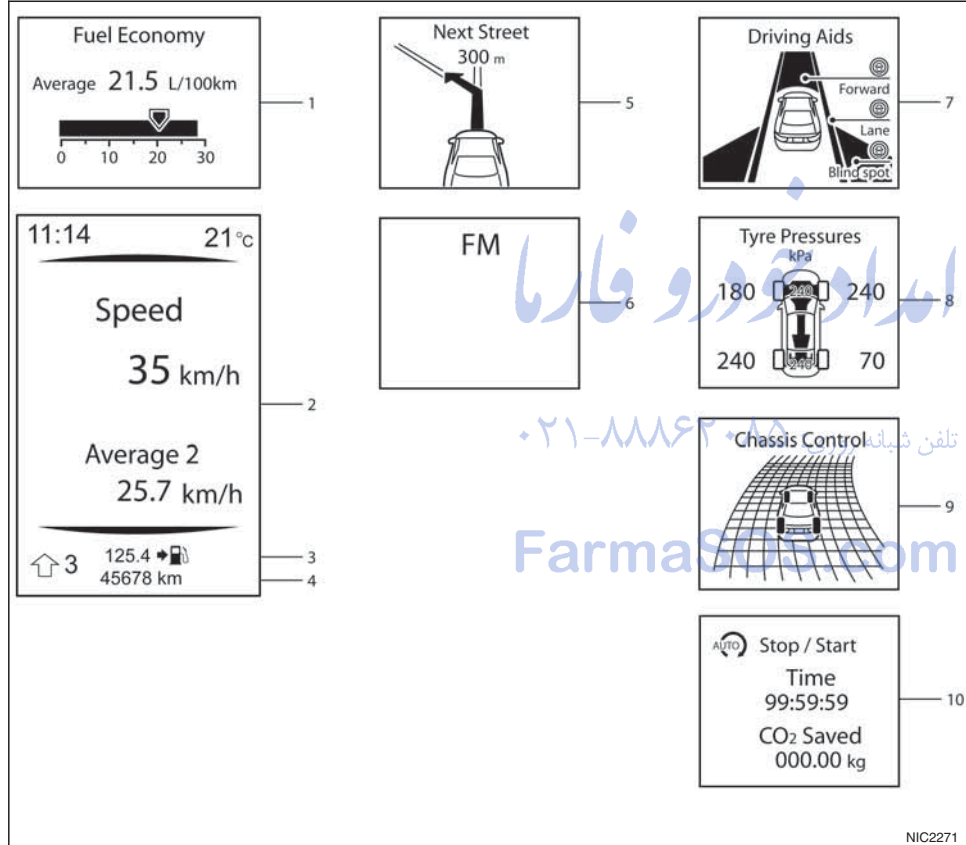

Switches for the trip computer are located on the left side of the steering wheel and on the switch panel ①. To operate the trip computer, push the switches as shown above.

Each time the ▲ or ▼ switch is pushed, the display will change.

1. [Fuel economy] (l (litre)/100 km, km/l(litre) or MPG)

Current fuel consumption:

The current fuel consumption mode shows the current fuel consumption.

Average fuel consumption:

The average fuel consumption mode shows the average fuel consumption since the last reset. Push the ENTER switch for longer than 1 second to enter the Reset menu.

The display is updated every 30 seconds. For about the first 500 m (1/3 mile) after a reset, the display shows “—”.

Push ENTER briefly to show the second Fuel Economy page.

2. [Speed] and [Average speed] (km/h or MPH)

The (digital) speed shows the current speed at which the vehicle is travelling.

The average speed mode shows the average vehicle speed since the last reset. Push the ENTER switch for longer than 1 second to enter the Reset menu.

The display is updated every 30 seconds. The first 30 seconds after a reset, the display shows “—”.

3. [Range] (dte — km or mile)

The distance to empty (dte) mode provides you with an estimation of the distance that can be driven before refuelling. The dte is constantly being calculated, based on the amount of fuel in the fuel tank and the actual fuel consumption.

The display is updated every 30 seconds.

The dte mode includes a low range warning feature. If the fuel level is low, the warning is displayed on the screen.

When the fuel level drops even lower, the dte display will change to “—”.

- If the amount of fuel added is small, the display just before the ignition switch is placed in the “OFF” position may continue to be displayed.
- When driving uphill or rounding curves, the fuel in the tank shifts, which may momentarily change the display.

4. Elapsed [time] and [trip distance] (km or mile)

Elapsed [time]:

The elapsed time mode shows the time since the last reset. Push the ENTER switch for longer than 1 second to enter the Reset menu. (The trip odometer is also reset at the same time.)

[Trip distance]:

The trip odometer mode shows the total distance the vehicle has been driven since the last reset. Push the ENTER switch for longer than 1 second to enter the Reset menu. (The elapsed time is also reset at the same time.)

5. Navigation (where fitted)

When the route guidance is set in the navigation system, this item shows the navigation route information.

For more details, see the separately provided NissanConnect Owner's manual.

6. Audio

The audio mode shows the status of audio information.

For more details, see “FM AM radio with CD player (where fitted)” in the “4. Display screen, heater and air conditioner, and audio system” section or the separately provided NissanConnect Owner's manual.

7. [Driving aids] (where fitted)

The driving aids mode shows the operating condition for the following systems.

- Lane Departure Warning (LDW)
- Blind Spot Warning (BSW)
- Forward Emergency Braking

Push ENTER to access the driving aids setting menu.

For more details, see “Blind Spot Warning (BSW) system (where fitted)” in the “5. Starting and driving” section, “Lane Departure Warning (LDW) system (where fitted)” in the “5. Starting and driving” section, and/or “Forward emergency braking system (where fitted)” in the “5. Starting and driving” section.

8. [Tyre pressures] (where fitted)

The tyre pressure mode shows the pressure of all four tyres. The displayed values are only available while the vehicle is being driven.

When the [Low Tyre Pressure] warning appears, the display can be switched to the tyre pressure mode by pushing the ENTER switch to reveal additional details on the displayed warning.

9. [Chassis control]

When either the Active Trace Control (where fitted), Active Engine Brake (where fitted), Hill start Assist (where fitted) or the Active Ride Control system is operated, it shows the operating condition. See “Chassis control” in the “5. Starting and driving” section and “Hill Start Assist (HSA) system” in the “5. Starting and driving” section for more details.

10. [Stop/Start] system (where fitted)

The Stop/Start system mode shows the CO₂ savings and the engine stop time. (See “Stop/Start System (where fitted)” in the “5. Starting and driving” section.)

[Trip CO₂ saving] and engine stop time:

The trip CO₂ saving and engine stop time mode shows the CO₂ saving and engine stop time since the last reset.

The CO₂ saving and engine stop time can be reset by pushing the ENTER switch for longer than 1 second.

[Total CO₂ saving] and engine stop time:

The total CO₂ saving and engine stop time mode shows:

- The estimated CO₂ exhaust emissions prevented.
- The engine stop time that the engine has been stopped by the Stop/Start System.

NOTE **The Total CO₂ saving and engine stop time values cannot be reset and show accumulated Stop/Start System information since the vehicle was built.**

11. Warning check

The current warnings are displayed. If no warning is present, “No Warnings” is displayed.

[CLOCK] AND [OUTSIDE AIR TEMPERATURE]

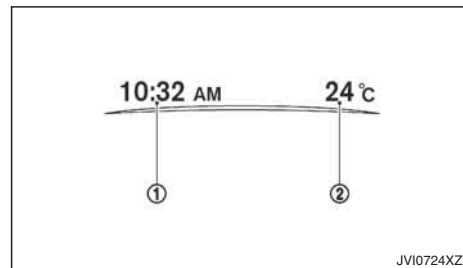

The clock ① and outside air temperature ② are displayed on the upper side of the vehicle information display.

[Clock]

For details of how to set the clock, see “Setting the clock” in the “4. Display screen, heater and air conditioner, and audio system” section or the separately provided NissanConnect Owner’s manual.

[Outside air temperature] (°C or °F)

The [outside air temperature] is displayed in °C or °F in the range of –40 to 60°C (–40 to 140°F).

The outside temperature sensor is located in front of the radiator. The sensor may be affected by road or engine heat, wind directions and other driving conditions. The display may differ from the actual outside temperature or the temperature displayed on various signs or billboards.

TRAFFIC SIGN RECOGNITION (where fitted)

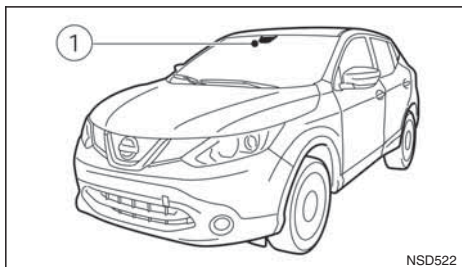

The Traffic Sign Recognition (TSR) system provides the driver with information about the most recently detected speed limit. The system captures the road sign information with the multi-sensing front camera unit ① located in front of the interior rear-view mirror and displays the detected signs in the vehicle information display. For vehicles equipped with NissanConnect, the speed limit displayed is based on a combination of navigation system data and live camera recognition. TSR information is always displayed at the top of the vehicle information display, and optionally in the main central area of the display screen. See “[Contents selection]” earlier in this section for details of how to adapt the display of TSR information.



WARNING

The TSR system is only intended to be a support device to provide the driver with information. It is not a replacement for the driver's attention to traffic conditions or responsibility to drive safely. It cannot prevent accidents due to carelessness. It is the driver's responsibility to stay alert and drive safely at all times.

System operation



FarmaSOS.com

The traffic recognition system displays the following types of road sign:

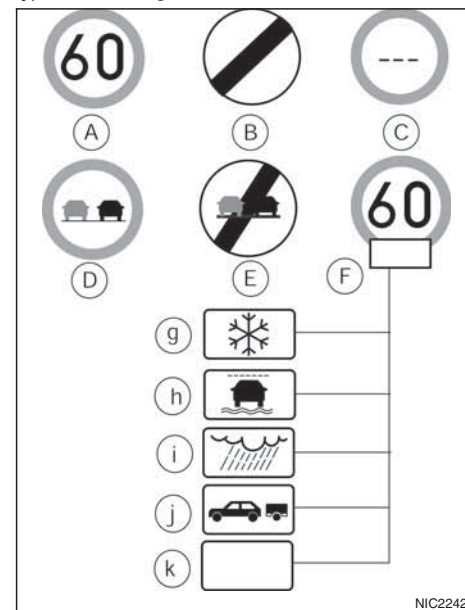

TSR: available road signs

- (A) Latest detected speed limit.
- (B) National speed limit
- (C) No speed limit information.
- (D) No-overtaking zone.
- (E) End of no-overtaking zone.

Ⓕ Conditional speed limit, with the following available conditions:

- Ⓖ Snow
- Ⓕ Slip (rain 1)
- Ⓖ Rain (rain 2)
- Ⓖ Towing
- Ⓖ Generic

CAUTION

- **The Traffic Sign Recognition (TSR) system is intended as an aid to careful driving. It is the driver's responsibility to stay alert, drive safely, and observe all road regulations that currently apply, including looking out for road signs.**
- **The Traffic Sign Recognition (TSR) system may not function properly under the following conditions:**
 - **When rain, snow or dirt adheres to the windscreen in front of the TSR camera unit.**
 - **When the headlights are not bright due to dirt on the lens or if the aiming is not adjusted properly.**
 - **When strong light enters the camera unit. (For example, the light directly shines on the front of the vehicle at sunrise or sunset.)**
 - **When a sudden change in brightness occurs. (For example, when the vehicle enters or exits a tunnel or under a bridge.)**

- **In areas not covered by the navigation system.**
- **If there are deviations in relation to the navigation, for example due to changes in the road routing.**
- **When overtaking buses or trucks with speed stickers.**

Turning the TSR system on and off

Turning the LDW system on or off is done using the [Settings] menu in the vehicle information display. For details, see "Vehicle information display" in the "2. Instruments and controls" section.

Perform the following steps to enable or disable the TSR system:

1. In the [Settings] menu, select the [Driver Assistance] key.
2. Touch [Traffic Sign] to turn the system ON/OFF.

System temporarily unavailable

If the vehicle is parked in direct sunlight under high temperature conditions (over approximately 40 C (104 F) and then started, the TSR system may be deactivated automatically. The [Not available high cabin temperature] warning message will appear in the vehicle information display.

Action to take:

When the interior temperature is reduced, the TSR system will resume operating automatically.

System Malfunction

If the TSR system malfunctions it will be turned off automatically and the system [Malfunction]/[System error] warning message will appear in the vehicle information display.

Action to take:

If the TSR [Malfunction]/[System error] message appears, pull off the road at a safe location and stop the vehicle. Turn the engine off and restart the engine. If the TSR [Malfunction]/[System error] message continues to appear, have the system checked by a NISSAN dealer.

Maintenance

The TSR uses the same multi-sensing front camera unit that is used by the Lane Departure Warning (LDW) system, located in front of the interior rear view mirror. For maintenance of the camera, see "Multi-sensing camera unit maintenance" in the "5. Starting and driving" section.

WIPER AND WASHER SWITCH



WARNING

In freezing temperatures the washer fluid may freeze on the windscreen and obscure your vision. Warm the windscreen with the defogger before you wash it.

CAUTION

- Do not open/release the bonnet when the front wiper arms are raised from their original position.
- Do not operate the washer continuously for more than 15 seconds.
- Do not operate the washer if the reservoir tank is empty or frozen.

WINDSCREEN

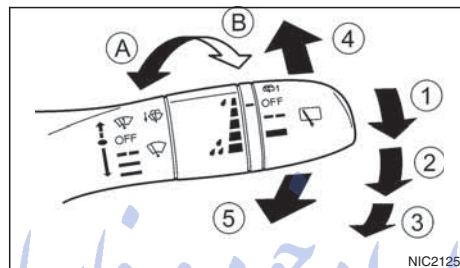

Type A (without AUTO mode)

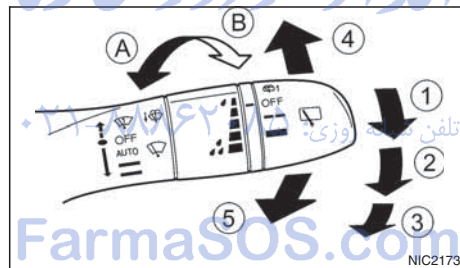

Type B (with AUTO mode)

The windscreen wiper and washer can be operated when the ignition switch is in the ON position.

Wiper operation

Move the lever up or down to operate the wiper at the following speeds:

- ①: **Intermittent** (▬ ▬) – Type A or **AUTO** – Type B (where fitted) operates the rain-sensing auto wiper system. (See “Rain sensor (where fitted)” later in this section).
 - The intermittent operation speed can be adjusted by rotating the ring forward (A) (slower) or backward (B) (faster).
 - The wiper operation speed will vary in accordance with the vehicle speed in the AUTO position. For example, when the vehicle speed is high, the intermittent operation speed will be faster.
- ②: **Low** (▬) – for continuous low speed operation
- ③: **High** (▬) – for continuous high speed operation
- ④: – for a single sweep operation of the wiper.

Washer operation

Pull the lever towards you (5) to operate the washer. For every fifth operation of the wiper and washer, the headlight washing system (where fitted) will be activated to clean the headlights. The headlight washing system is only activated while the headlight switch is in the  position. See “Headlight cleaner (where fitted)” later in this section.

Wiper drip wipe system (where fitted):

The wiper will also operate once about 3 seconds after using the washer. This operation is to wipe washer fluid that has dripped on the windscreen.

Rain sensor (where fitted)

The sensor of the rain-sensing auto wiper system located on the upper part of the windscreen, in front of the rear view mirror, can automatically turn on the wipers and adjust the wiper speed depending on the rainfall intensity and the vehicle speed when the lever in the AUTO position ①.

The sensitivity can be adjusted by rotating the ring of the wiper switch forward (A) — less sensitive, or backward (B) — more sensitive.

NOTE

- Be sure to turn off the rain-sensing auto wiper system when the car is in the car wash.
- Leaving the lever in AUTO position will not harm the rain sensor system, although occasional unexpected activation of the wipers may occur.
- If the switch is left in the AUTO position, the wipers may operate unexpectedly when dirt, fingerprints, oil film or insects are covering the windscreen of the rain sensor location. The wipers may also operate when exhaust gas or moisture affects the rain sensor.
- Do not touch or cover the windscreen where the rain sensor is located. The wipers may operate unexpectedly when the wiper switch

is in the AUTO position and the ignition switch is in the ON position. This can cause an injury or a wiper damage.

REAR WINDOW

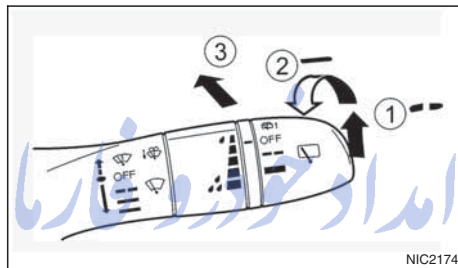

WARNING

In freezing temperatures the washer solution may freeze on the rear window and obscure your vision. Warm the rear window with the rear window defogger before using the rear wipers.

CAUTION

- Do not operate the washer continuously for more than 15 seconds.
- Do not operate the washer if the reservoir tank is empty or frozen.

The rear window wiper and washer operates when the ignition switch is in the ON position.

Wiper operation

Turn the switch clockwise to the intermittent (■, ①) position or continuous (■, ②) position for wiper operation.

To stop the wiper operation, turn the switch back to the OFF position.

Washer operation:

To operate the washer, push the lever towards the front of the vehicle ③ until the desired amount of washer fluid is spread on the rear window. The wiper will automatically operate several times.

Wiper drip wipe system (where fitted):

The wiper will also operate once about 3 seconds after using the washer. This operation is to wipe washer fluid that has dripped on the windscreen.

The mode can be turned off. For details, see “Vehicle information display” later in this section.

Reverse synchronisation function (where fitted)

When the windscreen wiper switch is in either the intermittent or AUTO (where fitted), low or high speed position, placing the shift lever in the R (Reverse) position will operate the rear window wiper.

The mode can be turned off. For details, see “Vehicle information display” later in this section.

THERMACLEAR HEATED WINDSCREEN BUTTON

NOTE

In the AUTO position (where fitted), the rear wiper will not begin to sweep when the shift lever is placed in the R position. It waits until the front wipers have made the first sweep.

THERMACLEAR HEATED WINDSCREEN (where fitted)

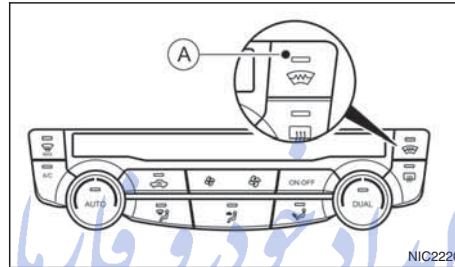

Models with ThermaClear Heated Windscreen (where fitted)

Ⓐ ThermaClear Heated Windscreen On/Off

To defog/defrost the windscreen glass, start the engine and push the ThermaClear button Ⓐ. The indicator light will come on. Push the button again to turn the ThermaClear system off.

The ThermaClear system will turn off automatically after approximately 4 minutes — if the windscreen clears before this time, push the button again to turn the ThermaClear system off.

NOTE

- Before activating the ThermaClear system make sure to remove excess snow/ice from the windscreen
- Electrical conductors embedded in the windscreen provide the heating of the windscreen.

If damage occurs to the windscreen have the ThermaClear system checked by a NISSAN dealer or qualified workshop.

- The ThermaClear Heated Windscreen performance may be reduced or deactivated to preserve the battery.
- NISSAN recommends using the ThermaClear system to support defogging of the windscreen. For more information, see “Heater and air conditioner operation” in the “4. Display screen, heater and air conditioner, and audio system” section.
- During use of the ThermaClear system the Stop/Start System is unavailable.

DEFOGGER SWITCH

REAR WINDOW DEFOGGER

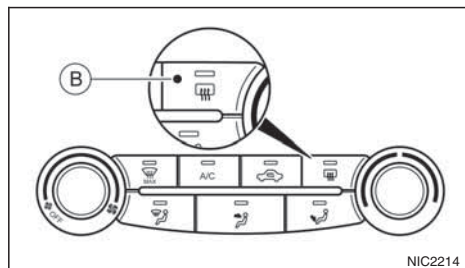

Models with manual air conditioning (where fitted)

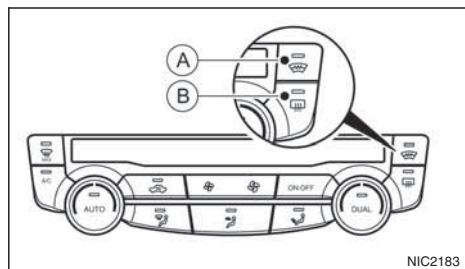

Models with automatic air conditioning and ThermoClear system (where fitted)

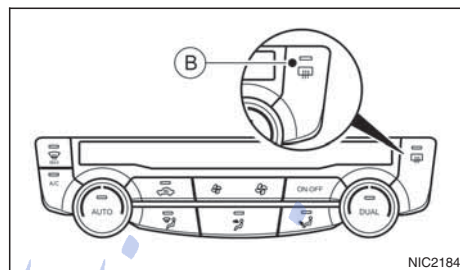

Models with automatic air conditioning and without ThermoClear system

(A) ThermoClear system On/Off. See “ThermoClear Heated Windscreen button” earlier in this section.

(B) Rear window defogger On/Off

To defog/defrost the rear window glass, start the engine and push the rear window defogger switch (B). The indicator light will come on. Push the switch again to turn the defogger off.

The defogger will turn off automatically after approximately 15 minutes — if the rear window clears before this time, push the switch again to turn the defogger off.

For more information, see “Heater and air conditioner operation” in the “4. Display screen, heater and air conditioner, and audio system” section.

CAUTION

When cleaning the inner side of the rear window, be careful not to scratch or damage the electrical conductors.

NOTE

When the ThermoClear system is turned on the Stop/Start System (where fitted) will not be activated.

OUTSIDE MIRROR DEFOGGER (where fitted)

The outside rear-view mirrors will be defogged when the rear defogger switch is activated.

HEADLIGHT AND TURN SIGNAL SWITCH

NISSAN recommends you to consult the local regulations concerning the use of lights.

HEADLIGHT SWITCH

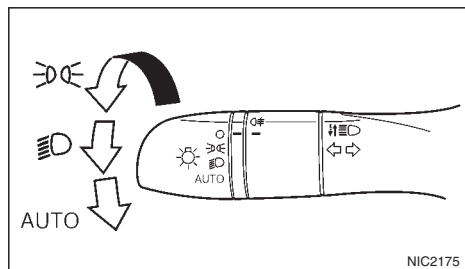

Lighting

Turn the switch to the **OFF** position:

The front side, tail, number plate and instrument lights will come on. The indicator light

in the instrument panel will come on.

Turn the switch to the **INDICATOR** position:

The headlights will come on and all the other lights remain on.

CAUTION

Never leave the light switch on for extended periods of time while the engine is not running.

Daytime light system (where fitted)

Even if the headlight switch is off, the front daytime running lights will come on when the engine is running.

When the light switch is turned to the **OFF** or **INDICATOR** position, the daytime running lights will turn off.

Autolight system (AUTO – where fitted)

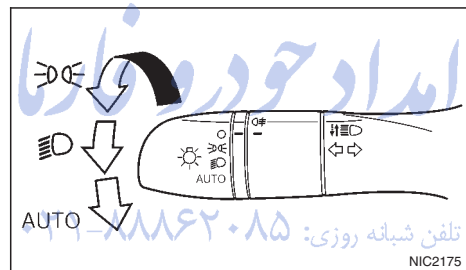

The autolight system allows the headlights to be set so they turn on and off automatically. When active, the autolight system will:

- Turn on the headlights, front side, tail, number plate and instrument panel lights automatically when it gets dark.
- Turn off all the lights when it gets light.

To activate the autolight system:

1. Turn the headlight switch to the AUTO position.
2. Turn the ignition switch to ON.

To disable the autolight system:

Turn the switch to the **OFF**, **OFF** or **INDICATOR** position.

High beam select

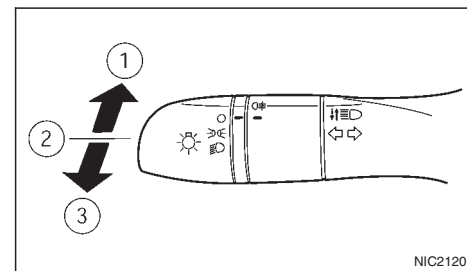

- ① To select the high beam when in the **INDICATOR** position, push the lever forward. The high beam lights come on and the **INDICATOR** indicator light illuminates.
- ② Pull the lever back to select the low beam (**INDICATOR** position).
- ③ Pulling the lever towards you will flash the headlight high beam, even when the headlight switch is off.

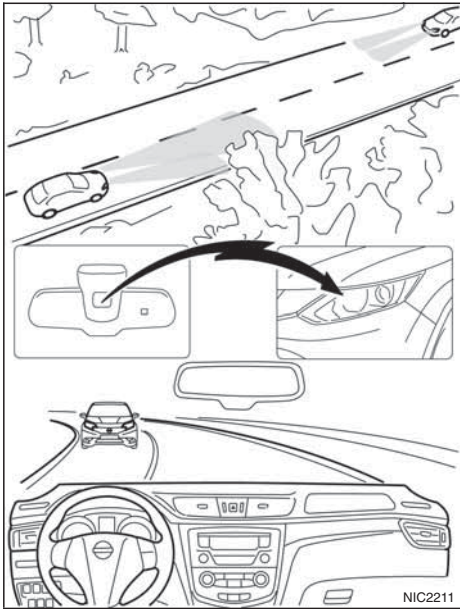

DYNAMIC HIGH BEAM ASSISTANT (where fitted)

A camera-controlled high beam assistant which changes from low beam to high beam automatically.

Precautions:



WARNING

The dynamic high beam assistant cannot compensate for road and weather circumstances while driving. The system saves the driver from having to operate the switch. The driver always remains responsible for choosing the correct light setting.

Specific situations in which to operate the head light switch manually:

- In heavy rain, snowy conditions. (general poor visibility and bad weather conditions).
- When the vehicle sensors are dirty, covered or broken.

Dynamic high beam assistant activated:



When the headlight switch is in the AUTO position, the light sensor detects darkness, and the vehicle speed is over 20 km/h (15 MPH), the dynamic high beam assistant is operational. The dynamic high beam assistant indicator light  in the instrument panel is on.

The system operates as follows:

- High beam comes on automatically in dark conditions:
If the vehicle speed is over 40 km/h (25 MPH) and no other road users are recognised. The  high beam light (blue) comes on additionally.

- High beam turns off automatically:
If the vehicle speed drops below 25 km/h (15 MPH) or other road users are detected.
The  High beam light (blue) turns off.

To disable the dynamic high beam assistant:

To turn the dynamic high beam assistant off turn the head light switch to the OFF, , or  position.

“Friendly Lighting”

The “Friendly Lighting” function is a convenience facility. It allows you to provide lighting from the vehicle after the ignition switch has been turned to the LOCK position and the headlight switch is in the OFF or AUTO (where fitted) position. Pulling the headlight switch toward you once will activate the headlight for approximately 30 seconds. After that period of time, it will automatically switch off.

It is possible to pull the headlight switch up to four times to increase the lighting period up to 2 minutes.

NOTE

The “Friendly Lighting” function can be cancelled by switching the ignition switch to the Acc or ON position again.

Battery save function

The battery save feature prevents your vehicle from discharging the battery after you have left the external lights, map lamps or room lamps on when exiting the vehicle. This occurs when the ignition switch or ignition knob is switched to the “OFF” or LOCK position after the engine has been running.

NOTE

The next time the engine is started the external lights, map lamps or room lamp will come on again

Battery save function for external lights:

If the ignition switch is turned to the "OFF" position after driving but the external lights are accidentally left on, the external lights will automatically be switched off as soon as the driver's door is opened.

It is possible to leave the external lights on permanently by switching them back on using the headlight switch while the ignition switch is still in the LOCK or "OFF" position. In this case, the light reminder chime will sound when the driver's door is opened.

Battery save function for interior light:

The interior light will automatically be switched off after a period of time if it has been accidentally left on.

TURN SIGNAL SWITCH

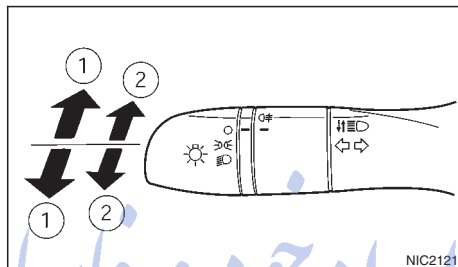

Lane change signal

Move the lever only part of the way up or down ① to signal a lane change (right or left). The indicator lights will flash three times before cancelling automatically. تلفن شبانه روزی: ۰۸۵۰۶۰۸۸۸۸۸۸۸

NOTE

This feature will only work if the 3 flash turn signal setting has been set to ON in the Vehicle Settings menu of the vehicle information display (see "[Vehicle settings]" earlier in this section).

Direction indicator

Move the lever up or down ② to indicate right or left. When the turn is completed, the turn signal is automatically cancelled.

FOG LIGHT SWITCH

FRONT FOG LIGHT (where fitted)

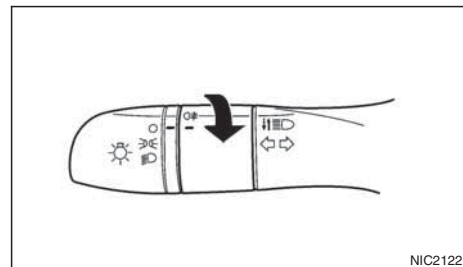



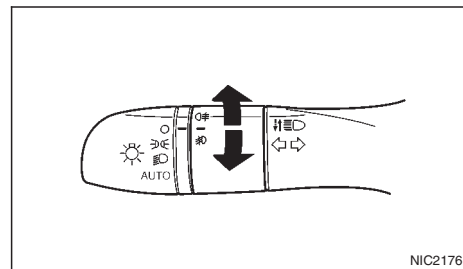

Type A: Rear fog light only



Type B: Front and rear fog lights

The front fog lights should only be used when visibility is seriously reduced – generally, to less than 100 m (328 ft).

To turn the front fog lights on, turn the headlight switch to the  or  or AUTO (where fitted) position and turn the fog light switch to the  position. The front fog lights and indicator light will come on. The fog light switch will return to the "OFF" position (—). For additional information, see "Warning/indicator lights and audible reminders" earlier in this section.



To turn the front fog lights off, turn the fog light switch to the  position again. The front fog lights and indicator light will turn off. The fog light switch will return to the "OFF" position.



NOTE

If the headlight switch is turned to the "OFF" position (—), the front fog light will switch off automatically.

REAR FOG LIGHT (where fitted)

The rear fog light should only be used when visibility is seriously reduced – generally, to less than 100 m (328 ft).

To turn the rear fog light on, turn the headlight switch to the  or  or AUTO (where fitted) position and turn the fog light switch to the  position. The rear fog light and indicator light will come on. The fog light switch will return to the "OFF" position (—). For additional information, see "Warning/indicator lights and audible reminders" earlier in this section.

If the front fog lights (where fitted) are already turned on with the headlight switch in the  position, you can turn on the rear fog light without first turning the headlight switch to the  or AUTO (where fitted) position.

To turn the rear fog light off, turn the fog light switch to the  position again.

NOTE

If the headlight switch is turned to the "OFF" position (—), the rear fog light will switch off automatically.

امداد خودرو فارما

تلفن شبانه روزی: ۰۲۱-۸۸۸۶۲۰۸۵

FarmaSOS.com

HEADLIGHT AIMING CONTROL

HEADLIGHT AIMING CONTROL SWITCH (where fitted)

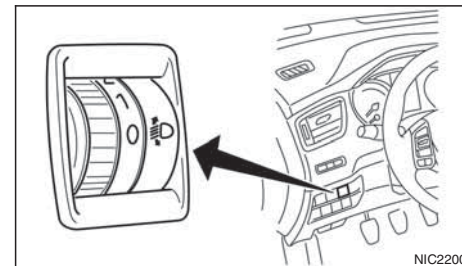

LHD models

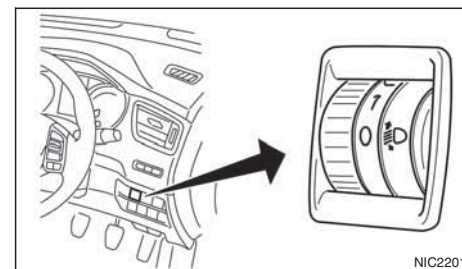

RHD models

Depending on the number of occupants in the vehicle and the load it is carrying, the headlight axis may be higher than desired. If the vehicle is travelling on a hilly road, the headlights may directly hit the rear-view mirror of the vehicle ahead or the wind-screen of an oncoming vehicle. The light axis can be

lowered using the switch located on the driver's side of the instrument panel, next to the steering wheel.

The higher the number designated on the switch, the lower the axis.

When travelling with no heavy load on a flat road, select position 0.

AUTOMATIC AIMING CONTROL (LED headlights)

Vehicles with LED headlights are equipped with an automatic levelling system. The headlight axis is controlled automatically.

NISSAN recommends consulting local regulations on the use of lights.

HEADLIGHT CLEANER (where fitted)

To clean the headlights, pull the windscreen washer switch towards you while the headlight switch is in the  position and the ignition switch is in the ON position.

NOTE

The headlight cleaner will automatically operate every fifth operation of the wiper and washer switch.

HEADLIGHT CLEANER SWITCH (where fitted)

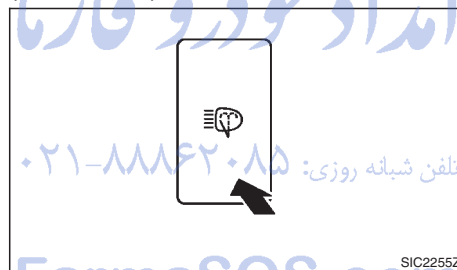

Headlight cleaner switch (where fitted)

The headlight cleaner operates when the headlight and turn signal switch is in the  position and the ignition switch is in the ON position.

To operate the headlight cleaner push the headlight cleaner switch located on the driver's side, lower left side of the instrument panel.

CAUTION

- Do not operate the cleaner continuously for more than 15 seconds.

- Do not operate the cleaner if the washer fluid reservoir is empty or frozen.

See "Window washer fluid/headlight cleaner fluid (where fitted)" in the "8. Maintenance and do-it-yourself" section for details on refilling the reservoir tank.

HORN



To sound the horn, push the centre pad area ① of the steering wheel.

SEAT HEATING (where fitted)

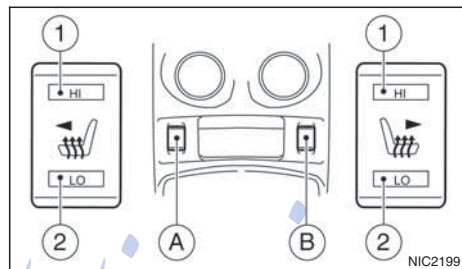

The front seats are warmed by built-in heaters.

The switches are located on the centre console and can be operated independently from each other (A for the left-hand side seat, B for the right-hand side seat).

1. Turn the ignition switch to the ON position.

NOTE

The seat heater can only be activated when the ignition switch is in the ON position.

2. Start the engine.

3. Select the heat range:

- Press the forward part of the switch (HI) ① to activate the "HIGH" heat setting.
- Press the rear part of the switch (LO) ② to activate the "LOW" heat setting.
- For no heat, the switch has a central "OFF" position between "HIGH" and "LOW".

4. The seat heater switches illuminate when either heat setting is selected and will remain on as long as the switch is on.
5. When the vehicle's interior has warmed-up, or before you leave the vehicle, be sure to turn the seat heater system off.

CAUTION

- Do not use the seat heater system for a long period of time when the engine is not running, otherwise the battery could run down.
- Do not put anything on the seat that insulates the heat, such as a blanket, cushion, seat cover, etc. Otherwise, the seat may overheat.
- Do not place anything hard or heavy on the seat or pierce it with a pin or similar object. This may damage the heater.
- Any liquid spilled on a heated seat should be removed immediately with a dry cloth.
- When cleaning the seat, never use benzine, thinner or any similar materials.
- If any abnormalities are found or the heating does not operate, turn off the switch and have the system checked by a NISSAN dealer or qualified workshop.

POWER OUTLET

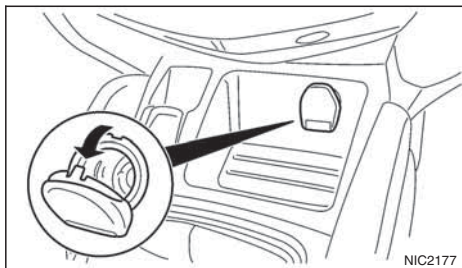

Centre console

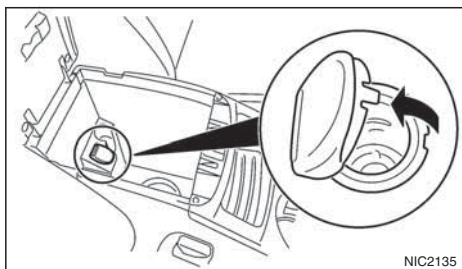

Front armrest

WARNING

Take care as the power outlet and plug may be hot during or immediately after use.

CAUTION

- This power outlet is not designed for use with a cigarette lighter unit.

- Do not use with accessories that exceed a 12 volt, 120 W (10 A) power draw. Do not use double adaptors or more than one electrical accessory.
- Use this power outlet with the engine running (do not use for extended periods of time with the engine stopped or idling).
- Avoid using when the air conditioner, headlights or rear window defogger are on.
- When not in use, be sure that the cap is closed. Do not allow water to come into contact with the outlet.
- Before inserting or disconnecting a plug, be sure to turn off the power switch of the electrical accessory being used or remove the key from the ignition to turn the Acc power of the vehicle off.
- Fully push the plug in sufficiently. If sufficient contact is not made, the plug may overheat or the internal temperature fuse may blow.

FarmasOS.com

STORAGE

STORAGE TRAYS

WARNING

To help prevent injury in an accident or sudden stop, do not place sharp objects in the trays.

GLOVE BOX

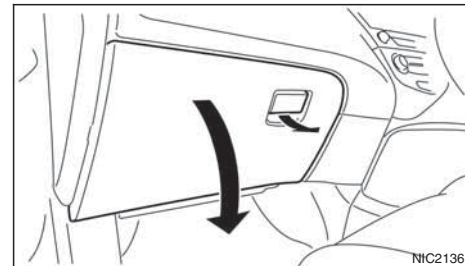

WARNING

Keep the glove box lid closed while driving to help prevent injury in an accident or a sudden stop.

To open the glove box, lift the latch and lower the lid.

Towards the rear of the glove box an elastic strap can be used to hold the Owner's Manual pack.

Sunglasses holder (where fitted)



WARNING

The sunglasses holder should not be used while driving so that full attention may be given to vehicle operation.

The glove box contains a sunglasses storage area, which is accessible when the glove box is open.

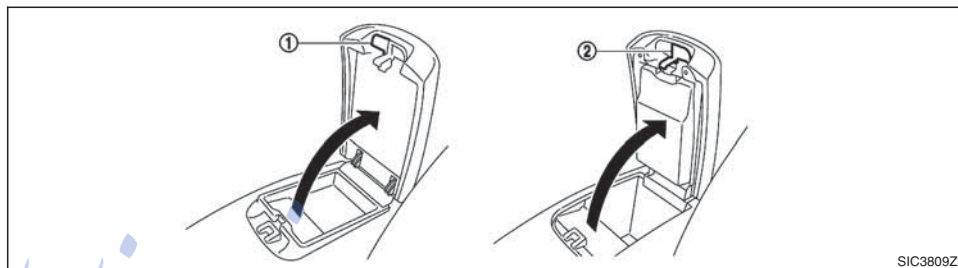

CONSOLE BOX



WARNING

The centre console box should not be used while driving so that full attention may be given to vehicle operation.

To open the console box lid, pull the lever ① or ② and pull up the lid.

When the lever ① on the right side is pulled, the upper case is available for storing some small items. When the lever ② on the left side is pulled, the bottom case is available for storing some larger ones.

To close, push the lid down until the lock latches.

The console box lid contains designated storage areas, for example, for CDs, coins, and business cards.

Cable slots

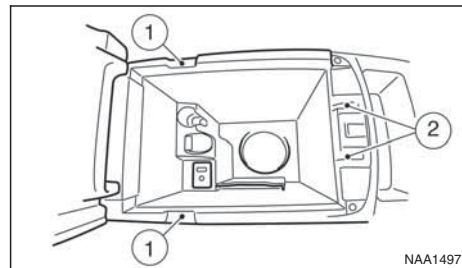

The console box contains openings in the sides ① and front ② to allow cables to be routed through the console box lid. For more information, see "Power outlet" earlier in this section and "AUX socket" later in this section

ROOF RAIL (where fitted)

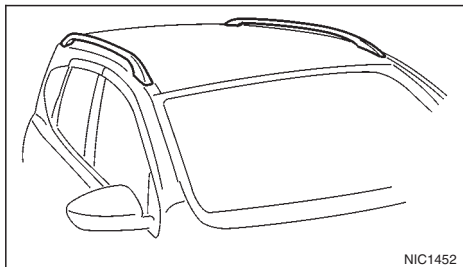

Luggage can be carried on the roof by securing crossbars to the roof rail. Follow all crossbar manufacturers instructions for installing and use of the crossbars. The roof rail is designed to carry loads (luggage plus crossbars) below 75 kg (165 lb). Overloading may cause damage to the vehicle.

PARCEL SHELF

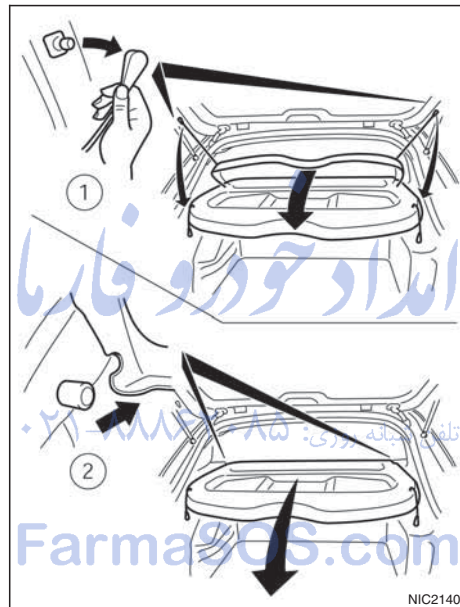

WARNING

- Never put anything on the parcel shelf, no matter how small. Any object on it could cause an injury in case of an accident or if the brakes are applied suddenly.

- Do not leave the parcel shelf in position when it is disengaged from the grooves.
- Properly secure all cargo to help prevent it from sliding or shifting. Do not place cargo higher than the seatbacks. In a sudden stop or collision, unsecured cargo could cause personal injury
- The child restraint top tether strap may be damaged by contact with the parcel shelf or items in the luggage compartment area. Remove the parcel shelf from the vehicle or store it in its storage space. Also, secure any loose items in the luggage compartment. Your child could be seriously injured or killed in a collision if the top tether strap is damaged.

Removal

1. Open the back door (see "Back door lock" in the "2. Pre-driving checks and adjustments" section).
2. Detach both of the ropes (left and right) ① from the inside of the back door.
3. Detach the parcel shelf by simply pulling it rearwards through the back door opening.

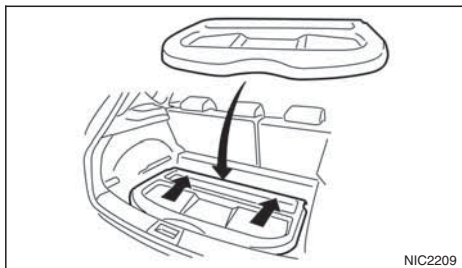

CAUTION

Make sure the parcel shelf is carefully stored when not in use in order to prevent any damage.

NOTE

The parcel shelf can be securely stored under the luggage compartment floor boards (see "Installation" later in this section).

Installation

1. Open the back door.
2. Insert the parcel shelf by pushing it forwards as far as possible through the back door opening.
3. Attach the corresponding ropes to each side ① of the back door.
4. Close the back door (see "Back door lock" in the "2. Pre-driving checks and adjustments" section).

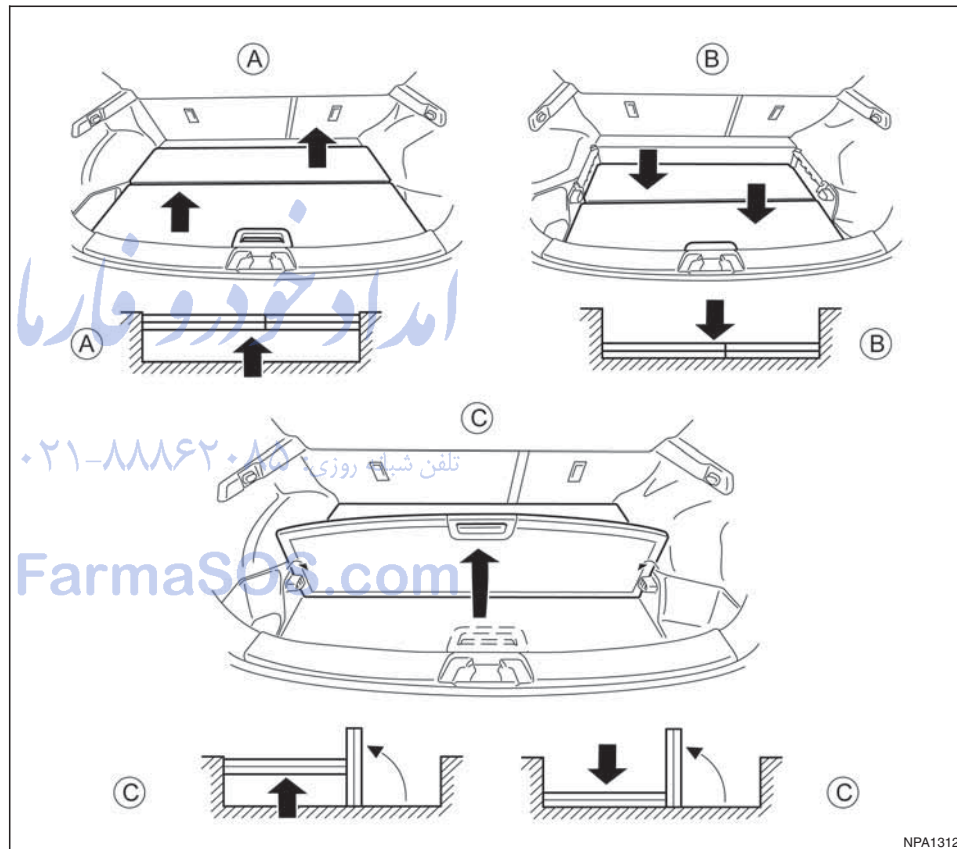

NPA1312

LUGGAGE COMPARTMENT/BOOT FLOOR (where fitted)



WARNING

- Properly secure all cargo with ropes or straps to help prevent it from sliding or shifting. Do not place cargo higher than the seatbacks. In a sudden stop or collision, unsecured cargo could cause personal injury.
- Do not put objects heavier than 50 kg (110 lbs) on the load floor.
- Never allow anyone to ride in the luggage area. It is extremely dangerous to ride in a luggage area inside of a vehicle. In a collision, people riding in these areas are more likely to be seriously injured or killed.
- Only two anchorage points identified by the top tether labels can be used for top tether strap anchorage. Under no circumstances should the luggage hooks be used for top tether strap anchorage.

The luggage (cargo) compartment or boot floor has a dual surface (wet and dry), or dual position system with loose floorboards that allow different luggage compartment arrangements.

CAUTION

- The carpet finish should face up for all dry use applications.
- The smooth surface should be used only when loading wet objects.

- The load should be distributed evenly and should not exceed 50 kg (110 lb) on any of the boards/panels.
- To avoid any damage, the panels/boards should be placed in the lower position (B) for heavy loads and securely held with ropes or straps to prevent any load shift.

Upper position (A)

This position provides a flat load floor when the rear seat backs are folded forward. It also serves as a concealed load area for objects placed below the boards.

NOTE

The parcel shelf can be securely stored under the luggage compartment floor boards.

Move the boards as illustrated by lifting and sliding each board into the upper position (A).

- 1) Remove the larger floorboard as illustrated by lifting it into the upper position (A).
- 2) Repeat the operation with the smaller board.

Lower position (B)

This position maximises the load space in the luggage compartment.

Move both boards as illustrated by lifting and sliding each board into the lower position (B).

Vertical positions (C)

These positions provide further subdivisions of the luggage space by standing either one of the boards vertically in the midway slots provided in the side trim.

LUGGAGE HOOKS

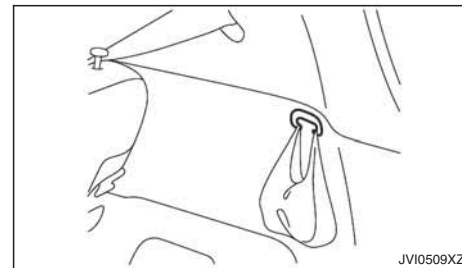

The luggage hooks are for shopping bags, etc.



WARNING

- Do not apply a total load of more than 3 kg (7 lb) to the hook.

WINDOWS

POWER WINDOWS

The power window switches are located on the door panels and will only operate when the ignition switch is in the ON position.



WARNING

- Make sure that all passengers have their hands, etc. inside the vehicle before operating the power windows.
- Never leave children or adults who would normally require the support of others alone in the vehicle. They could unknowingly activate switches or controls and inadvertently become involved in an accident.
- It is recommended to instruct all occupants in the safe operation of power windows with particular emphasis given to the safety and supervision of children.

The power windows only operate when the ignition switch is in the "ON" position.

To open a window, push down the power window switch.

To close a window, pull up the power window switch.

Driver's side main window switch

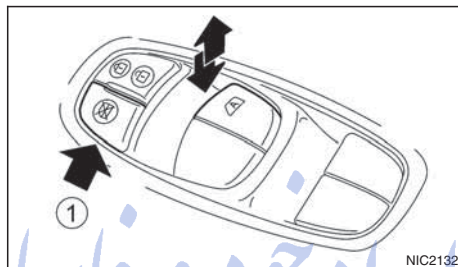

The driver's switch, which is the main switch, can control all of the windows.

Locking passengers' windows:

When the lock button (1) is pushed in, the passengers' windows cannot be operated. تلفن شبانه روز

To cancel the passengers' windows lock, push the lock button (1) again.

FarmaSOS.com

Passenger's window switch

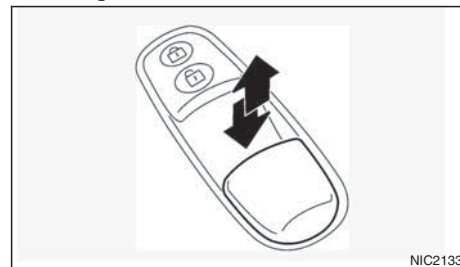

The passenger's switch can control its corresponding window.

When the passenger's window lock button on the driver's side is pushed in, the passenger's switch cannot be operated.

Automatic function

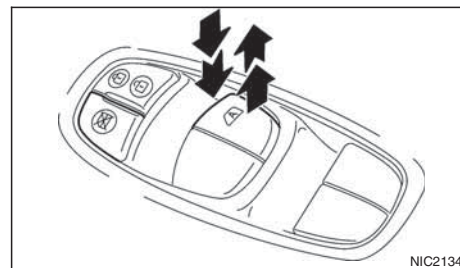

Automatic function is available for the switch that has an **A** mark on its surface.

The automatic function enables a window to fully open or close without holding the switch down or up.

To fully open the window, push the power window switch down to the second detent and release the switch. To fully close the window, pull the power window switch up to the second detent and release the switch. The switch does not have to be held during window operation.

To stop the window open/close operation during the automatic function, push down or pull up the switch in opposite direction.

Auto-reverse function:



WARNING

- There is a small distance just before the closed position which cannot be detected. Make sure that all passengers have their hands, etc. inside the vehicle before closing the windows.
- The auto-reverse function does not work when the window is closed manually (holding the switch in the close position).

The auto-reverse function enables a window to automatically reverse when something is caught in the window as it is closing by the automatic function. When the control unit detects an obstacle, the window will be lowered immediately.

Depending on the environment or driving conditions, the auto-reverse function may activate if an impact or load similar to something being caught in the window occurs.

Reinitialisation procedure after battery reconnection

Some power window functions (automatic close function, auto-reverse function) will not operate as described after the battery cable is disconnected or the electrical supply is interrupted. Perform the following procedure to initialise the power window functions.

1. Place the ignition switch in the "ON" position.
2. If the driver's window is closed, open it completely by operating the driver's window switch.
3. Pull up and hold the driver's window switch to close the driver's window. Hold the switch for approximately 5 seconds after the window has been fully closed, and then release it.
4. Check if the power window functions operate properly.

If you open or close the power window continuously, it may cause the power window not to operate properly. Perform the above procedure.

If the power window functions do not operate properly after performing the above procedure, repeat the steps. See a NISSAN dealer or qualified workshop, if necessary, for checking the power window system.

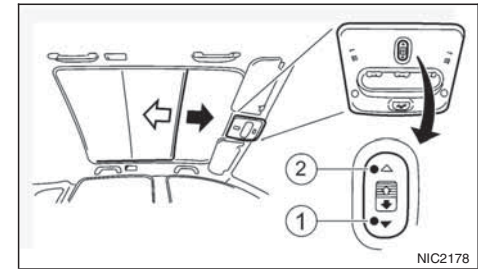

- ① Close
- ② Open

CAUTION

- Do not place heavy objects on the glass roof or surrounding area.
- Do not hang from the sunshade or hang any objects from it. It may cause damage or deformation to the sunshade.
- Close the sunshade when you leave the vehicle for extended periods of time to prevent the inside of the vehicle from reaching high temperatures.

INTERIOR LIGHTS

SUNSHADE OPERATION

The sunshade operates only when the ignition switch is in the ON position.



WARNING

Never allow hands or fingers, or any part of your body within operating range of the sunshade. You could be injured.

Opening and closing

Manual control:

To close the sunshade, press and hold the "CLOSE" side of the switch ① To stop the sunshade from closing fully, release the switch.

To open the sunshade press and hold the "OPEN" side of the switch ② To stop the sunshade from opening fully, release the switch.

Automatic operation:

To fully open or close the sunshade automatically, press briefly on the open or close side of the switch and then release. To stop the sunshade from opening or closing, press either side of the switch.

Auto-reverse function:

When the control unit detects something caught in the sunshade, the sunshade will open automatically.

NOTE

The auto-reverse function remains active whether the sunshade is being closed manually or automatically.

CAUTION

Do not use for extended periods of time with the engine stopped. This could discharge the battery.

NOTE

The interior lights will go off after a period of time unless the ignition switch is in the Acc or ON position.

ROOM LIGHT CONTROL SWITCH

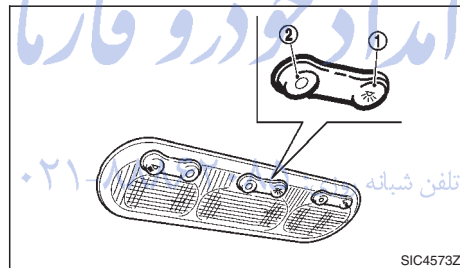

The room light control switch has three positions: ON ①, OFF ② and centre ③.

ON position

When the switch is in the ON position ①, the light will illuminate.

OFF position

When the switch is in the OFF position ②, the light will not illuminate, regardless of the condition.

Centre position

When the switch is in the centre position, the light comes on when a door is opened

ROOM LIGHT TIMER (where fitted)

The room light will stay on for a period of time when:

- The ignition is switched off.
- The doors are unlocked.
- Any door is opened and then closed.

The timer is cancelled, and the interior light will turn off when:

- The doors are locked.
- The ignition switch is turned to the ON position.

MAP LIGHTS (where fitted)

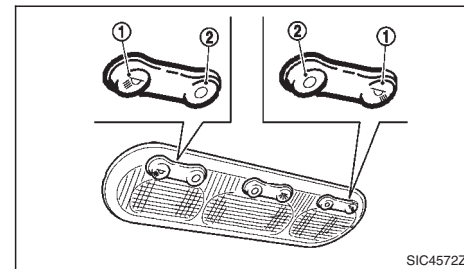

Operate the map light switch to turn the map light on or off.

①: ON position

②: OFF position

REAR ROOM/READING LIGHT (where fitted)

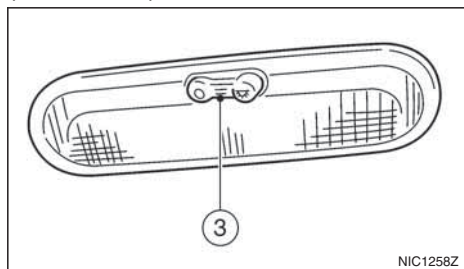

Room light (where fitted)

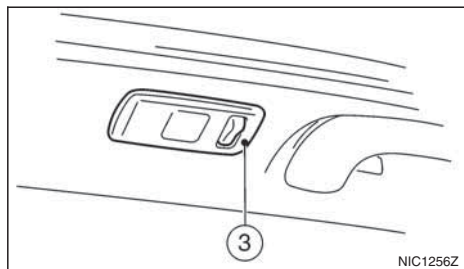

Reading light (where fitted)

The light can be switched on or off by pressing the switch ③.

LUGGAGE COMPARTMENT LIGHT

The light comes on automatically when the back door is opened. When the back door is closed, the light goes off.

VANITY MIRROR LIGHT (where fitted)

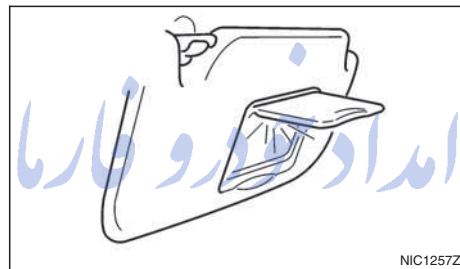

The light on the vanity mirror will turn on when the cover is opened.

FarmaSOS.com

NOTE

امداد خودرو فارما

تلفن شبانه روزی: ۰۲۱-۸۸۸۶۲۰۸۵

FarmaSOS.com

3 Pre-driving checks and adjustments

Keys	3-2	Inside door handle	3-10
NISSAN Anti-Theft System (NATS)* key	3-2	Power door lock switch	3-10
Intelligent Key (where fitted)	3-2	Child safety lock — rear doors.....	3-11
Key number	3-3	Back door lock	3-11
New keys	3-3	Security system	3-12
Emergency/mechanical key (Intelligent Key models)	3-3	Alarm system (where fitted)	3-12
Integrated keyfob/remote control system	3-4	NISSAN Anti-Theft System (NATS).....	3-13
Switching from Convenience mode to		Bonnet release	3-14
Anti-hijack mode (where fitted).....	3-5	Fuel filler lid	3-15
Using the remote keyless entry system.....	3-5	Fuel filler lid opener lever	3-15
Locking the doors.....	3-5	Fuel filler cap.....	3-15
Unlocking the doors.....	3-5	Parking brake switch	3-16
Keyfob operation failure	3-5	Driving away when towing a trailer	3-17
Intelligent Key system (where fitted)	3-6	Steering wheel.....	3-18
Intelligent Key operating range.....	3-6	Sun visors	3-18
Using Intelligent Key system.....	3-6	Mirrors.....	3-18
Locking/unlocking	3-7	Inside rear-view mirror	3-18
Starting the engine with the Intelligent Key	3-8	Automatic anti-dazzling inside mirror (where fitted).....	3-19
Door locks	3-8	Outside rear-view mirrors.....	3-19
Super Lock system (RHD models)	3-8	Vanity mirror	3-20
Locking/unlocking with the key (vehicle dead battery)	3-9		

KEYS

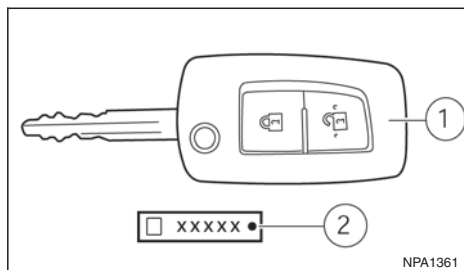

Integrated keyfob and key

NPA1361

1. NATS Key
2. Key number plate

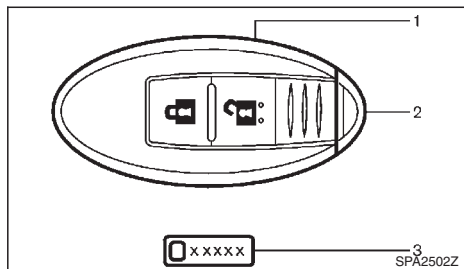

Intelligent Key with emergency/mechanical key

SPA2502Z

1. Intelligent Key
2. Emergency/Mechanical key (inside the Intelligent Key), see “Emergency/mechanical key (Intelligent Key models)” later in this section
3. Key number plate

NISSAN ANTI-THEFT SYSTEM (NATS)* KEY

Your vehicle can only be driven with the keys specific to your vehicle. Only NISSAN Anti-Theft System (NATS)* keys can be used with your vehicle (see “Security system” later in this section).

INTELLIGENT KEY (where fitted)

Your vehicle can only be driven with the Intelligent Keys, which are registered to your vehicle’s Intelligent Key system components and NISSAN Anti-Theft System (NATS*) components. As many as 4 Intelligent Keys can be registered and used with one vehicle. The new keys must be registered by a NISSAN dealer or qualified workshop prior to use with the Intelligent Key system and NATS of your vehicle. Since the registration process requires erasing all memory in the Intelligent Key components when registering new keys, be sure to take all Intelligent Keys that you have to the NISSAN dealer or qualified workshop.

*: Immobilizer

CAUTION

- Be sure to carry the Intelligent Key with you. Do not leave the vehicle with the Intelligent Key inside.
- Be sure to carry the Intelligent Key with you when driving. The Intelligent Key is a precision device with a built-in transmitter. To avoid damaging it, please note the following.

- The Intelligent Key is water resistant; however, wetting may damage the Intelligent Key. If the Intelligent Key gets wet, immediately wipe until it is completely dry.
- Do not allow the Intelligent Key to come into contact with water or salt water this could affect the system function.
- Do not bend, drop or strike it against another object.
- Do not place the Intelligent Key for an extended period in a place where temperatures exceed 60°C (140°F).
- Do not change or modify the Intelligent Key.
- Do not use a magnetic key holder.
- Do not place the Intelligent Key near equipment that produces a magnetic field such as a TV, audio equipment and personal computers.
- If an Intelligent Key is lost or stolen, NISSAN recommends erasing the ID code of that Intelligent Key. This will prevent the Intelligent Key from unauthorised use to unlock the vehicle. For information regarding the erasing procedure, please contact a NISSAN dealer or qualified workshop.

KEY NUMBER

A key number plate ③ is supplied with your key

Record the key number on the "Security Information" page at the end of this manual and keep it in a safe place, but **not in the vehicle**. The key can only be duplicated using an original key or the original key number. The key number is required when you have lost all of the keys and do not have the original key to duplicate from. If the key is lost, or you need extra keys, provide an original key or the key number to a NISSAN dealer or qualified workshop.

NISSAN does not record key numbers, so it is very important that you keep a record of your key number.

NEW KEYS

As many as four NATS keys can be registered to one vehicle at any one time. New keys must be registered to the NATS components of your vehicle by a NISSAN dealer.

When registering a new key at a NISSAN dealer, you are requested to bring all of your NATS keys with you. This is necessary because the registration process will erase and reprogram the memory of your vehicle's NATS components.

NOTE

A key number is only required if you have lost all of your keys and do not have one to duplicate from. If you still have a key, this key can be duplicated by a NISSAN dealer.

EMERGENCY/MECHANICAL KEY (Intelligent Key models)

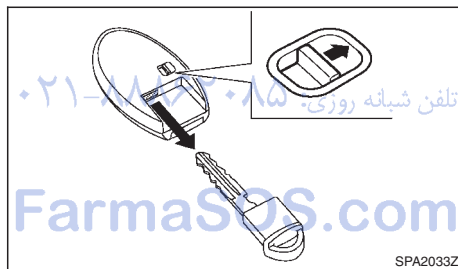
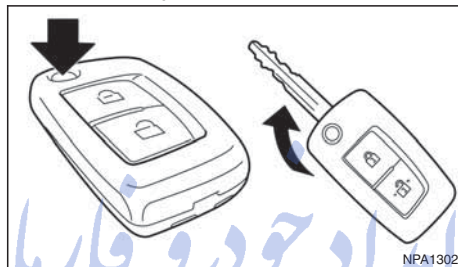

The emergency key can be used to unlock the driver's door and start the engine in emergency situations (e.g. Intelligent Key dead battery).

Integrated keyfob and key:

- To use the mechanical key, push the release button located on top of the key. The key will unfold from its housing until it locks in place.

Intelligent Key:

- To remove the mechanical key, release the lock knob at the back of the Intelligent Key.
- To install the mechanical key, firmly insert it into the Intelligent Key until the lock knob returns to the lock position.

Use the mechanical key to lock or unlock the doors. (See "Door locks" later in this section.)

For further details on accessing and using the emergency key, see "Ignition switch (where fitted)" in the "5. Starting and driving" section.

NOTE

For the driver side door, it is normal for the key not to go all the way into the key cylinder.

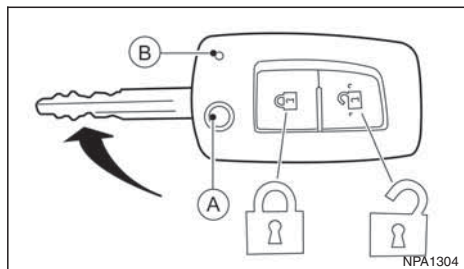

INTEGRATED KEYFOB/REMOTE CONTROL SYSTEM

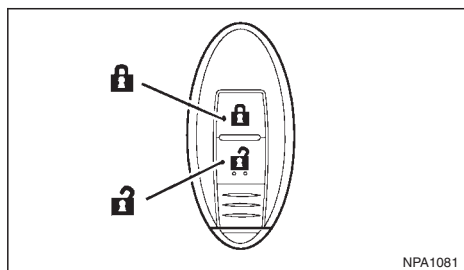

Key with Integrated keyfob



Intelligent Key

- (A) Key release button
- (B) Status indicator LED
-  Lock button
-  Unlock button



The remote keyless entry system can operate all door locks (including the back door) using the integrated keyfob. The integrated keyfob can operate at a distance of approximately 5 m (15 ft) from the

vehicle (the effective distance depends upon the conditions around the vehicle and the state of the keyfob battery).

As many as 5 remote controllers can be used with one vehicle. For information about the purchase and use of additional remote controllers, contact a NISSAN dealer or qualified workshop.

The integrated keyfob will not function under the following conditions:

- When the distance between the integrated keyfob and vehicle is more than approximately 5 m (15 ft).
- When the integrated keyfob battery is discharged.
- When the key is in the ignition switch.

All doors can be locked or unlocked from the outside by pressing the “LOCK”  or “UNLOCK”  button on the integrated keyfob.

For Super Lock system models only:

When the vehicle is occupied, never lock the doors with the integrated keyfob. Doing so will trap the occupants, since the Super Lock system prevents the doors from being opened from the inside.



WARNING

Only operate the integrated keyfob lock button in full and clear view of the vehicle to prevent anybody being trapped inside the vehicle.

CAUTION

- **When locking the doors using the integrated keyfob, be sure not to leave the key in the vehicle.**
- **Always remove the ignition key or Intelligent Key, close all windows before operating the keyfob door lock system.**
- **Ensure that the driver's door is securely closed before operating the integrated keyfob door lock system for correct operation of the system.**
- **Do not allow the integrated keyfob, which contains electrical components, to come into contact with water or salt water. This could affect the system function.**
- **Do not drop the integrated keyfob.**
- **Do not strike the integrated keyfob sharply against another object.**
- **Do not place the integrated keyfob for an extended period in an area where temperatures exceed 60°C (140°F).**

If a integrated keyfob is lost or stolen, NISSAN recommends erasing the ID code of that integrated keyfob from the vehicle. This may prevent the unauthorised use of the integrated keyfob to unlock the vehicle. For information regarding the erasing procedure, contact a NISSAN dealer or qualified workshop.

For information regarding the replacement of a battery, see "Integrated keyfob/Intelligent Key battery replacement" in the "8. Maintenance and do-it-yourself" section.

SWITCHING FROM CONVENIENCE MODE TO ANTI-HIJACK MODE (where fitted)

Selective unlock or "Anti-hijack" mode (where fitted) allows the remote unlocking of only the driver's door to prevent an attacker from entering the vehicle via an unlocked passenger door.

As default, the unlock mode will be set to "Convenience" mode (all doors will unlock). Follow the instructions in "Vehicle information display" later in this section.

USING THE REMOTE KEYLESS ENTRY SYSTEM



WARNING

Super Lock system equipped models:

Failure to follow the precautions below may lead to hazardous situations. Make sure the Super Lock system activation is always conducted safely.

- When the vehicle is occupied, never lock the doors with the integrated keyfob. Doing so will trap the occupants, since the Super Lock system prevents the doors from being opened from the inside of the vehicle.
- Only operate the integrated keyfob "LOCK" button when there is a clear view of the ve-

hicle. This is to prevent anybody from being trapped inside the vehicle through the Super Lock system activation.

For further details on the Super Lock system see "Door locks" later in this section.

LOCKING THE DOORS

CAUTION

Before operating the keyfob remote control:

- Remove the ignition key or Intelligent Key from the vehicle and close all windows.
- Check that the driver's door is securely closed.

Push the "LOCK" button  on the integrated keyfob.

- All the doors lock.
- The direction indicators flash once.

If the "LOCK" button  is pushed with all the doors locked, the direction indicators will flash once to remind you that the doors are already locked.

UNLOCKING THE DOORS

When you first receive the vehicle, the door unlock mode is set to unlock all the doors with one push of the "UNLOCK"  button.

Convenience mode

Unlock all doors, pressing the  button once. Setting the convenience mode is done using the [Settings] menu in the vehicle information display

(Select the [Unlocking] menu key). Also see "Vehicle information display" in the "2. Instruments and controls" section.

ANTI-HIJACK MODE (where fitted)

Unlock the driver's door only, pressing the  button once.

Press the  button twice to open all doors.

Setting the Anti-hijack mode is done using the [Settings] menu in the vehicle information display (Select the [Unlocking] menu key). Set [Selective Unlock] to off.

For more information see "Vehicle information display" in the "2. Instruments and controls" section.

Auto-relock (where fitted):

An auto-relock function will a short period after a full or partial unlock, if no further user action is taken. The auto-relock will be cancelled if any door is opened or the key is inserted into the ignition.

KEYFOB OPERATION FAILURE

The keyfob may not work properly if:

- **The keyfob battery is low.**
See "Integrated keyfob/Intelligent Key battery replacement" in the "8. Maintenance and do-it-yourself" section for keyfob battery replacement instructions and the required battery type.

INTELLIGENT KEY SYSTEM (where fitted)

- **The locking/unlocking system has been used continuously.**
An anti lock-abuse system prevents the lock motors from overheating and disables the keyfob locking operation for a short period of time if the system is used continuously.
- **The door handle is being pulled while the keyfob is being operated.**
- **The vehicle's battery is dead.**

NOTE

See [NO KEY Detected] warning, [Key battery low] indicator, [Key ID Incorrect] warning or Intelligent Key system warning in "Vehicle information display" in the "2. Instruments and controls" section for more information.

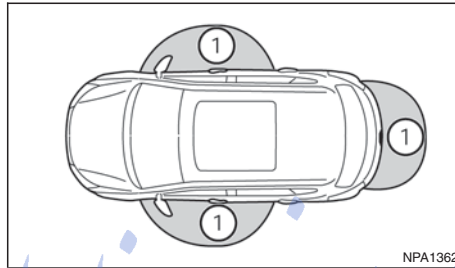

The Intelligent Key system is a convenient keyless entry system that allows you to operate your vehicle without using an actual key.



WARNING

Radio waves could adversely affect electric medical equipment. Those who use a pacemaker should contact the electric medical equipment manufacturer for the possible influences before use.

INTELLIGENT KEY OPERATING RANGE

The Intelligent Key functions can only be used when the Intelligent Key is within the specified operating range from the request (lock/unlock) button ①. When the Intelligent Key battery is discharged or strong radio waves are present near the operating location, the Intelligent Key system's operating range becomes narrower, and the Intelligent Key may not function properly.

The operating range is within 80 cm (31.50 in) from each request button ①.

If the Intelligent Key is too close to the door glass, door handle or rear bumper, the request switches may not function.

When the Intelligent Key is within the operating range, it is possible for anyone, even someone who does not carry the Intelligent Key, to push the request button to lock/unlock the doors including the back door.

USING INTELLIGENT KEY SYSTEM

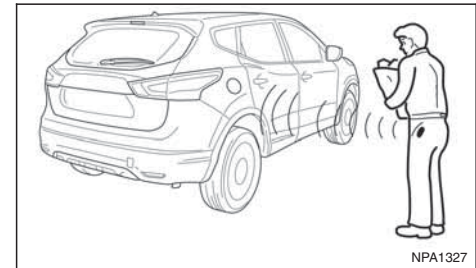

The request button will not function under the following conditions:

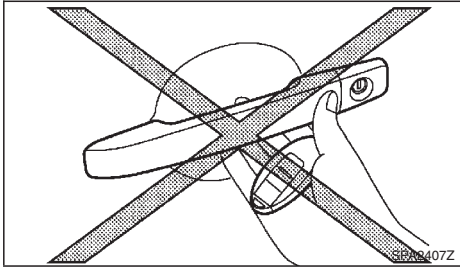

- When the Intelligent Key is left inside the vehicle
- When the Intelligent Key is not within the operational range
- When any door is open or not closed securely
- When the Intelligent Key battery is discharged

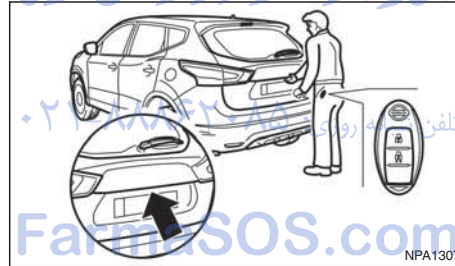
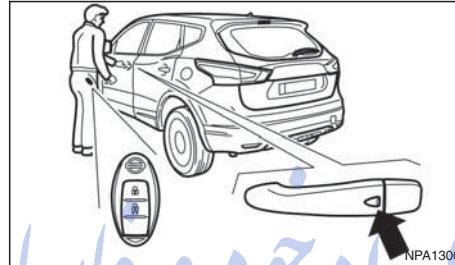

- Do not push the door handle request button with the Intelligent Key held in your hand as illustrated. The close distance to the door handle will cause the Intelligent Key system to have difficulty recognising that the Intelligent Key is outside the vehicle.
- After locking the doors using the door handle request switch, make sure that the doors have been securely locked by operating the door handles.
- To prevent the Intelligent Key from being left inside the vehicle, make sure you carry the key with you and then lock the doors.
- Do not pull the door handle before pushing the door handle request button. The door will be unlocked but will not open. Release the door handle once and pull it again to open the door.

LOCKING/UNLOCKING



The Intelligent Key system allows you to lock and unlock the driver's door, passenger doors, or back door without pressing the  or  button on the Intelligent Key or using the emergency key (driver's door key cylinder). When the Intelligent Key is near the vehicle, the door locks can be locked or unlocked by pressing the driver's door, front passenger's door or back door request button. And the direction indicators will flash as a confirmation.

Locking the doors

1. Make sure you have the Intelligent Key when exiting the vehicle.
2. Close all doors.
3. Press any of the request buttons (front doors or back door).
 - All doors and the back door will be locked.
 - The direction indicators flash once.
 - **Super Lock system equipped models:** The Super Lock system will be activated
4. Pull the door handles to confirm that the doors have been securely locked.

CAUTION

Do not leave the duplicate Intelligent Key inside the vehicle as the locking procedure logic will not work.

NOTE

If the Intelligent Key is left in the vehicle and the door/back door request button is pressed, a buzzer will sound to indicate that the Intelligent Key is still inside the vehicle.

Unlocking the doors

For details about the anti-hijack mode (where fitted) or the convenience mode settings, see "Switching from Convenience mode to Anti-hijack mode (where fitted)" earlier in this section or "[Unlocking]" in the "2. Instruments and controls" section.

Convenience mode:

Push the door/back door request button.

- All doors and the back door will be unlocked.
- The direction indicators flash twice.
- The message [All door unlock] appears in the vehicle information display.

Anti-hijack mode (where fitted):

1. Push the door/back door request button.
 - The corresponding door unlocks.
 - The direction indicators flash twice quickly.
2. Push the request button again within 5 seconds.
 - All the doors and the back door will be unlocked.
 - The direction indicators flash twice.

NOTE

- External interference may impair the Intelligent Key's operation. In this case, use the emergency key located in the Intelligent Key integrated keyfob. See "Door locks" later in this section for further details.
- If the vehicle is unlocked and no doors are opened for 2 minutes the doors will automatically be locked.

CAUTION

- Make sure the Intelligent Key battery is in good condition. Note that battery life may vary depending on condition, amount of use, ambient temperature, etc.

- The Intelligent Key contains a miniature radio transmitter that may be affected when placed near metal objects.
- Keep the Intelligent Key away from mobile phones, laptop computers and other metal objects or electronics.

STARTING THE ENGINE WITH THE INTELLIGENT KEY

See "Push-button ignition switch (where fitted)" in the "5. Starting and driving" section.

CAUTION

- Make sure you carry the Intelligent Key with you when starting and driving the vehicle.
- If the Intelligent Key is too far away from the passenger compartment, the vehicle may not start. See "Intelligent Key operating range" in the "3. Pre-driving checks and adjustments" section

FarmaSOS.com

DOOR LOCKS

SUPER LOCK SYSTEM (RHD models)



WARNING

Super Lock system equipped models:

Failure to follow the precautions below may lead to hazardous situations. Make sure the Super Lock system activation is always conducted safely.

- When the vehicle is occupied, never lock the doors with the integrated keyfob. Doing so will trap the occupants, since the Super Lock system prevents the doors from being opened from the inside of the vehicle.
- Only operate the integrated keyfob "LOCK" button when there is a clear view of the vehicle. This is to prevent anybody from being trapped inside the vehicle through the Super Lock system activation.

Pressing the "LOCK" button  on the integrated keyfob or locking the doors using one of the request buttons (Intelligent Key models) will activate the Super Lock system.

When the Super Lock system is active, none of the doors can be opened from inside the vehicle. This provides additional security in case of theft or break-in.

The Super Lock system will be released when all the doors are unlocked using the integrated keyfob or a request button (Intelligent Key models).

Emergency situations

If the Super Lock system is activated while you are inside the vehicle, for example by a traffic accident or other unexpected circumstances, follow the instructions below.

To release the Super Lock system:

- Insert the key into the ignition switch and turn it to the ON position.

All doors can now be unlocked and opened from inside the vehicle.

- Remove the key from the ignition switch and unlock the doors using the integrated keyfob “UNLOCK” button .

All doors can now be opened from inside the vehicle.

To unlock and open the driver’s door from inside the vehicle while the Super Lock system is active:

1. Open or break the driver’s door window.
2. Insert the key into the outside door key cylinder and turn it towards the rear of the vehicle.
3. The driver’s door will unlock and can now be opened from inside the vehicle.

Locking without activating the Super Lock system



WARNING

Do not leave the key inside the vehicle when leaving the vehicle.

Locking the doors using the door key cylinder or power door lock switch will not activate the Super Lock system. See “Locking/unlocking with the key (vehicle dead battery)” later in this section for further information.

LOCKING/UNLOCKING WITH THE KEY (vehicle dead battery)

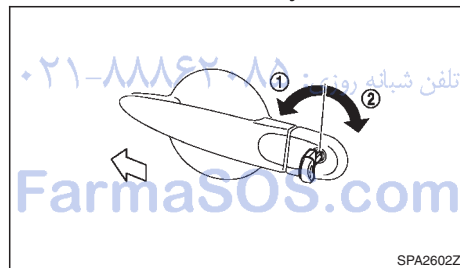

WARNING

- When leaving the vehicle, do not leave the key inside the vehicle.
- Never leave children unattended in a vehicle and always be sure you have your keys with

you when leaving. If an emergency occurs it may be more difficult to help them otherwise.

The driver’s door can be locked/unlocked from outside using the key/emergency key if the vehicle’s battery is dead.

To lock the door, insert the key into the driver’s door key cylinder and turn it towards the front of the vehicle ①.

To unlock the door, turn the key towards the rear of the vehicle ②.

See “Emergency/mechanical key (Intelligent Key models)” in the “5. Pre-driving checks and adjustments” section for instructions on accessing the Intelligent Key system Emergency key.

CAUTION

The alarm system will be triggered when the door is opened using the key (NISSAN alarm equipped models). To stop the alarm, turn the ignition key to the ON position or press the unlock button  on the integrated keyfob.

Initialising the system after vehicle battery loading or replacement

After recharging or replacing the battery, you should release (initialise) the system by:

- Inserting the key into the ignition switch and then turning it to the ON position.
- Unlocking the vehicle using the integrated keyfob.

INSIDE DOOR HANDLE

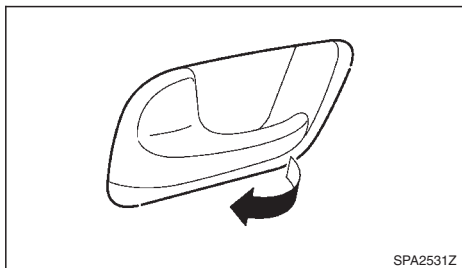

To unlock and open the door, pull the inside door handle as illustrated.

Models with Super Lock system (where fitted)

The door cannot be opened when the Super Lock system is activated.

POWER DOOR LOCK SWITCH



Power door lock light

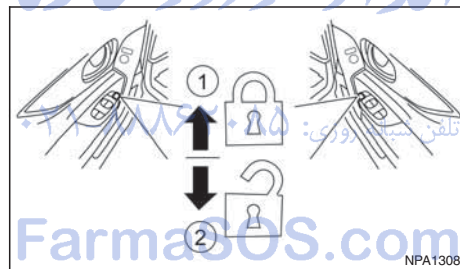

- ① Press to lock
- ② Press to unlock





WARNING

When leaving the vehicle, do not leave the key inside the vehicle.

The power door lock switch, located on the door



trimming, can be used to lock ① or unlock ② all doors simultaneously from inside the vehicle. The door lock indicator light () in the centre console comes on when the doors are locked.

NOTE

Models without the Super Lock system: If a door is manually opened from inside after having pressed the integrated keyfob “LOCK” button (). As a result, the door will unlock and the power door lock indicator light () goes out.

Locking the doors when leaving the vehicle (where fitted)

It is possible to lock all doors using the power door lock switch when leaving the vehicle:

1. Open the driver's door, remove the key from the ignition or the Intelligent Key (where fitted) from the passenger compartment.
2. Press the  side of the power door lock switch ①.
 - All doors except the driver's door lock
3. Close the driver's door.
 - The driver's door locks.
 - The  indicator light in the centre console comes on.
 - **Super Lock system models:** The Super Lock system is not activated.

- **Intelligent Key models:** If the Intelligent Key has been left inside the vehicle, all doors will unlock and an audible warning will sound.

Super Lock equipped models (RHD models)

If the doors are locked using the integrated keyfob lock button (🔒) or a request button (Intelligent Key models), the Super Lock system will be activated. The 🔒 indicator light in the centre console comes on to indicate that all doors are locked, but it will not be possible to use the 🔒 button of the power door lock switch to unlock the doors.

Locking the doors with the power door lock switch will not activate the Super Lock system.

CHILD SAFETY LOCK — REAR DOORS

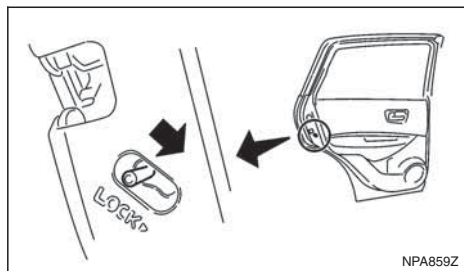

The child safety lock helps prevent doors from being opened accidentally, especially when small children are in the vehicle.

When the switch is in the LOCK position, the rear door can only be opened from the outside.

BACK DOOR LOCK

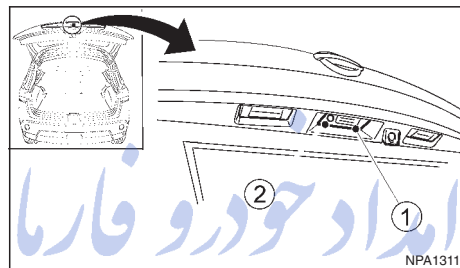

⚠️ WARNING

- Always check that the back door has been properly closed to prevent it from opening while driving.
- Do not drive with the back door opened. This could allow dangerous exhaust gases to be drawn into the vehicle.
- Closely supervise children when they are around the vehicle to prevent them from playing and being locked in the luggage compartment where they could be seriously injured. Keep the vehicle locked, with the back door closed, when not in use, and prevent children's access to the vehicle's keys.

The back door can be manually opened from the outside, and it is not locked by the power door lock system, by pushing the button (1) located above the rear number plate.

To open the back door, unlock it first with one of the following operations, then push the button (1).

- Push the request button (2) of the back door (where fitted). See "Intelligent Key system (where fitted)" earlier in this section.
- Push the 🔒 button on the Intelligent Key (where fitted). See "Intelligent Key system (where fitted)" earlier in this section.
- Push the 🔒 button on the integrated keyfob (where fitted). See "Integrated keyfob/remote control system" earlier in this section.
- Unlock all the doors using the key.
- Push the 🔄 side of the power door lock switch.

To close the back door, pull it down until it securely locks and if necessary, lock it with the power door lock system.

SECURITY SYSTEM

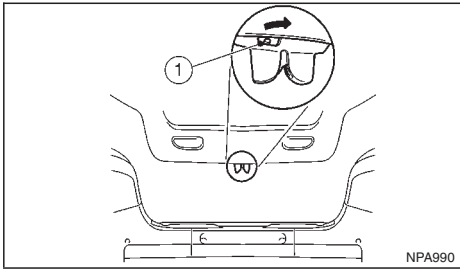

Vehicle dead battery – Back door lock release lever (where fitted)

The vehicle's back door can be unlocked from the inside when the battery is dead. Tilt the seatback down. Remove the cover from the lock and slide the release lever ① as illustrated. See "Rear seats" in the "1. Safety – Seats, Seat belts and Supplemental Restraint System" section for more information regarding the seat operation.

ALARM SYSTEM (where fitted)

The alarm system provides visual and audible alarm signals if parts of the vehicle are disturbed.

How to arm the alarm system

1. Close all doors, windows, back door and bonnet.
2. Lock the vehicle using the keyfob (lock button), for additional information, see "Integrated keyfob/remote control system" in the "3. Pre-driving checks and adjustments" section.

NOTE

If the vehicle is not fully locked, a door/bonnet/back door is open, or the ignition switch is in the ON position (after arming the system), the buzzer will sound. After correctly closing, the buzzer will stop.

Alarm system operation

The system will give the following alarm:

- The siren sounds intermittently and all direction indicators will flash.
- The alarm automatically turns off after 28 seconds.

The alarm is activated when:

- The volumetric sensing system (ultrasonic sensors) is triggered.
- Any door/the back door is opened.
- The bonnet is opened.

- The ignition circuit is turned on without the owner's key being used.

The alarm system will stop when:

- The vehicle is unlocked using the keyfob or intelligent key unlock button.
- The ignition switch or ignition knob is turned to the ON position with a registered NATS key.

If the system does not operate as described above, have it checked by your NISSAN dealer or qualified workshop.

Ultrasonic sensors (where fitted)

The ultrasonic sensors (volumetric sensing) detect movements in the passenger's compartment. When the alarm system is set to the armed position, it will automatically switch on the ultrasonic sensors.

It is possible to exclude the ultrasonic sensors (e.g. when leaving pets inside the car).

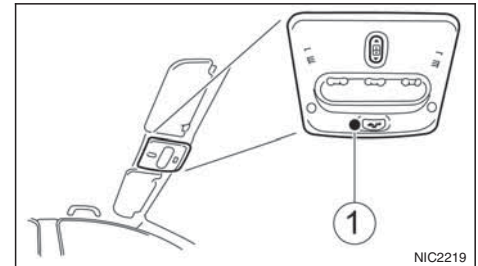

To exclude the ultrasonic sensors:

1. Press the ultrasonic sensor deactivation button ①.
2. Close the door(s)/bonnet/back door and press the lock button ② on the keyfob to lock all doors/back door.

The ultrasonic sensors are now excluded from the alarm system. All other functions of the system remain activated until the alarm system is disarmed again.

NOTE

One or any further number of presses of the ultrasonic sensor deactivation button ① excludes the ultrasonic sensors for the next time the alarm system is armed and only that instance. Pressing the button twice does not reactivate the system.

NISSAN ANTI-THEFT SYSTEM (NATS)

The NISSAN Anti-Theft System (NATS)* will not allow the engine to start without the use of the registered NATS key.

* Immobilizer

If the engine fails to start using the registered NATS key, it may be due to interference from another NATS key, an automated toll road device or an automated payment device on the key ring. Restart the engine using the following procedure:

1. Leave the ignition switch in the ON position for approximately 5 seconds.

2. Turn the ignition switch to the "OFF" or LOCK position and wait approximately 5 seconds.
3. Repeat steps 1 and 2.
4. Restart the engine while holding the device (which may have caused the interference) separated from the registered NATS key or NATS Intelligent Key (where fitted).

If this procedure allows the engine to start, NISSAN recommends placing the registered NATS key or NATS Intelligent Key (where fitted) on a separate key-ring to avoid interference from other devices.

تلفن شبانه روزی: ۰۲۱-۸۸۶۲۰۸۵

FarmaSOS.com

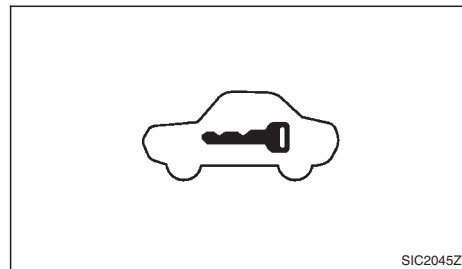

Meters and gauges (Type A)

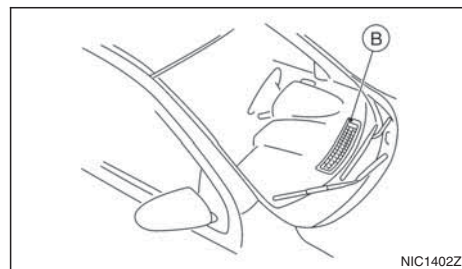

Driver's side (Type B)

NATS security warning/indicator light (where fitted)

One of the following functions (depending on the vehicle specifications) indicates that the vehicle is equipped with NATS:

- The NATS security warning light (Type A) is located in the meter panel and blinks whenever the ignition switch is in the LOCK, "OFF" or Acc position.

BONNET RELEASE

- The NATS security indicator light (Type **Ⓑ**) is located on the Driver's side of the dashboard and blinks whenever the ignition switch is in the LOCK, "OFF" or Acc position.

If the NISSAN Anti-Theft System (NATS) is malfunctioning, this light will remain on while the ignition switch is in the ON position.

If the light remains on and/or the engine will not start, see your NISSAN dealer for NATS service as soon as possible. Please bring all NATS keys or NATS Intelligent Keys when visiting your NISSAN dealer for service.

Additional information for RHD models

If the NATS is malfunctioning, this light will turn on after flashing six times while the ignition switch is in the ON position.

However, if the NATS security warning light turns off after the light has remained on for 15 minutes, there is a 10 second time slot to start the engine after the ignition is turned off. See your NISSAN dealer for NATS service as soon as possible.

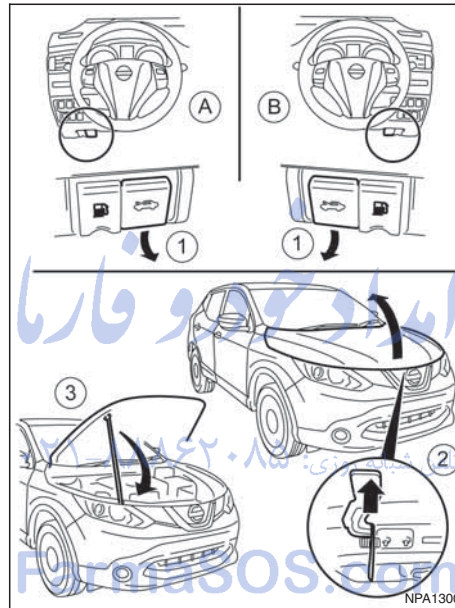

2. Pull the lever **Ⓐ**, at the front of the bonnet, with your fingertips and raise the bonnet.
3. Insert the support rod **Ⓒ** into the slot on the frame behind the headlight unit.
4. When closing the bonnet, replace the support rod in its original position, then slowly close the bonnet and make sure it locks into place.



WARNING

Always check whether the bonnet is closed and locked securely to prevent it from opening while driving. The vehicle should only be operated with the bonnet securely closed.

Ⓐ LHD models

Ⓑ RHD models

1. Pull the bonnet lock release lever **Ⓐ**, located below the instrument panel on the driver's side; the bonnet will spring up slightly.

FUEL FILLER LID

FUEL FILLER LID OPENER LEVER

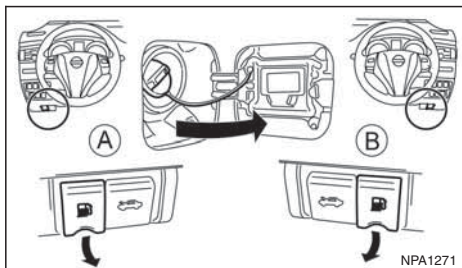

Ⓐ LHD models

Ⓑ RHD models

To open the fuel filler lid, pull up the opener lever, located below the instrument panel on the driver's side. To lock, close the fuel filler lid securely.

FUEL FILLER CAP

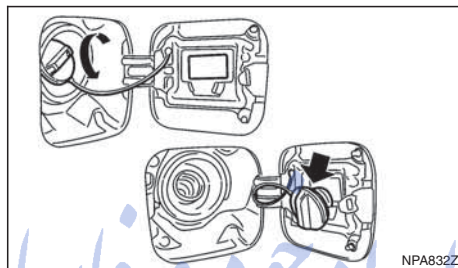

The fuel filler cap is a ratcheting type. Tighten the cap clockwise until ratcheting clicks are heard.

Put the fuel filler cap on the cap holder as illustrated while refuelling.



WARNING

- Fuel is extremely flammable and highly explosive under certain conditions. Always stop the engine and do not smoke or allow open flames or sparks near the vehicle when refuelling.
- Fuel may be under pressure. Turn the cap half a turn and wait for any hissing sound to stop, in order to prevent fuel from spraying out and causing possible personal injury.
- Use only a NISSAN fuel filler cap or exact equivalent as a replacement. It has a built-in safety valve needed for proper operation of

the fuel system and emission control system. An incorrect cap can result in a serious malfunction and possible injury.

CAUTION

If fuel is spilled on the vehicle body, flush it away with water to avoid paint damage.

PARKING BRAKE SWITCH

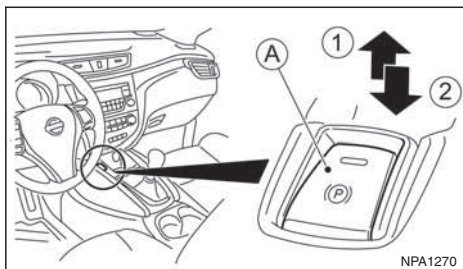

The electric parking brake can be applied or released by operating the parking brake switch (A).

To apply: Pull the switch (A) up ① the indicator light will illuminate.

To release: With the ignition switch in the ON position, depress the brake pedal and push the switch (A) down ②. The indicator light will turn off.

Before driving, check that the brake warning light (P) goes out. For additional information, see “Warning/indicator lights and audible reminders” in the “2. Instruments and controls” section.

The electric parking brake also has an auto apply and auto release function.

Manual transmission vehicles:

- Vehicle with key ignition switch:

The parking brake will automatically release when you drive away using the accelerator, and will automatically apply when the ignition switch is placed in the OFF position.

- Vehicle with push-button ignition switch:

The parking brake will automatically release when you drive away using the accelerator, and will automatically apply when you switch the engine off.

XTRONIC transmission vehicles:

The parking brake does not apply automatically. If applied manually, the parking brake will automatically release when you press the accelerator with the shift lever in Drive (D) or Reverse (R), provided:

- The driver is wearing a seat belt, or
- The driver accelerates away within 5 seconds of shifting from Park (P) or Neutral (N) to Drive (D) or Reverse (R).

If you have tried to start driving the vehicle while not wearing a seat belt, you will need to put on your seat belt and place the shift lever in Drive (D) or Reverse (R) again before the parking brake will release automatically.

If you have a vehicle with XTRONIC Transmission, and you require automatic parking brake application, please contact a NISSAN dealer.

To keep the electric parking brake released after turning off the ignition:

- Vehicle with key ignition switch:

While the ignition switch is in the ON position, press the brake pedal and push the parking brake switch (A), while turning the ignition switch OFF.

- Vehicle with push-button ignition switch:

While the engine is running, press the brake pedal and push the parking brake switch (A), while switching the ignition switch OFF.

The parking brake can also be released when the ignition switch is in the OFF position, provided the key is in the ignition switch; or for vehicles with push-button ignition switch before a door is opened. Press the brake pedal and push the parking brake switch (A).



WARNING

- Be sure the electric parking brake is released before driving. Failure to do so could cause brake failure and lead to an accident.
- Do not release the parking brake from outside the vehicle.
- Do not leave children unattended in a vehicle. They could release the parking brake and cause an accident.
- Before leaving the vehicle, confirm that the vehicle is held by the parking brake or transmission.

NOTE

- Do not start driving while the parking brake is applied this may cause the parking brake to overheat or reduce its effectiveness, which could result in an accident.

- A buzzer will sound if the vehicle is driven without releasing the parking brake. See “Audible reminders” in the “2. Instruments and controls” section.
- While the electric parking brake is applied or released, an operating sound is heard from the lower side of the rear seat. This is normal and does not indicate a malfunction.
- When the electric parking brake is frequently applied and released in a short period of time, the parking brake may not operate in order to prevent the parking brake system from overheating. If this occurs, operate the electric parking brake switch again after waiting approximately 1 minute.
- The electric parking brake can only be released with the ignition switch in the ON position.
- If the electric parking brake must be applied while driving in an emergency, pull up and hold the parking brake switch. When you release the parking brake switch, the parking brake will be released.
- While pulling up the electric parking brake switch while driving, the parking brake is applied and a chime sounds. The parking brake indicator light in the meter and in the parking brake switch illuminate. This does not indicate a malfunction. The electric parking brake indicator lights in the meter and in the parking brake switch turn off when the parking brake is released.

- Pull up the electric parking brake switch twice so that the maximum electric parking brake force is applied to the vehicle.
- When pulling the electric parking brake switch up with the ignition switch in the OFF or ACC position, the parking brake switch indicator light will continue to illuminate for a short period of time.

CAUTION

To park the vehicle in cold climates place the shift lever in 1st (1) or Reverse (R) (or in Park (P) for automatic (AT) vehicles), and place suitable chocks at both the front and back of a wheel with the electric parking brake released. If the electric parking brake is applied in cold climates, the brake may become frozen and cannot be released.

DRIVING AWAY WHEN TOWING A TRAILER

Please note the following points to prevent the vehicle from rolling back unintentionally on a gradient.

- Pull and hold the parking brake switch and press the accelerator. The parking brake will remain engaged and prevent any tendency to roll back down the slope.
- You can release the parking brake switch as soon as the engine is delivering enough power to the wheels.

Depending on the weight of the vehicle and trailer and the steepness of the slope, there may be a ten-

dency to roll back downhill when driving away from a standstill. You can prevent this by pulling up the parking brake switch as you press the accelerator (in the same way as with a conventional handbrake).

STEERING WHEEL

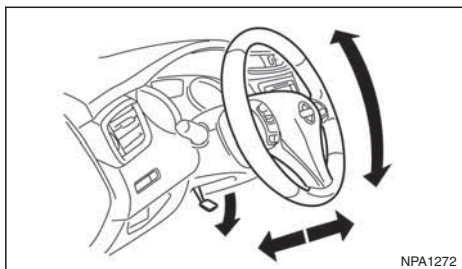

WARNING

Do not adjust the steering wheel while driving. You could lose control of your vehicle and cause an accident.

Release the lock lever as illustrated and adjust the steering wheel to the desired position (up or down, forwards or backwards). Firmly push the lock lever back into position to lock the steering wheel in place.

SUN VISORS

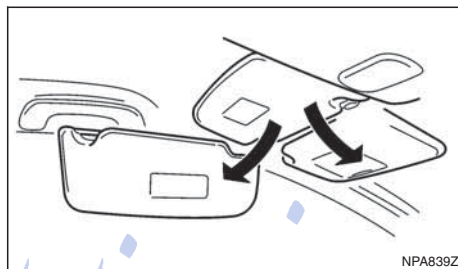

CAUTION

Do not store the sun visor before returning it to its original position.

1. To block out glare from the front, move the main sun visor downwards.
2. To block glare from the side, remove the main sun visor from the centre mount and move it to the side.

MIRRORS

INSIDE REAR-VIEW MIRROR

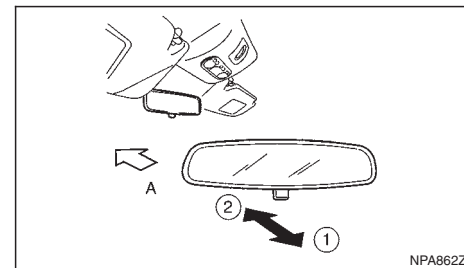

- ① Night position
- ② Day position
- (A) Front of the vehicle

The night position ① will reduce glare from the headlights of vehicles behind you at night.

WARNING

Only use the night position ① when necessary, as it reduces rear-view clarity.

AUTOMATIC ANTI-DAZZLING INSIDE MIRROR (where fitted)

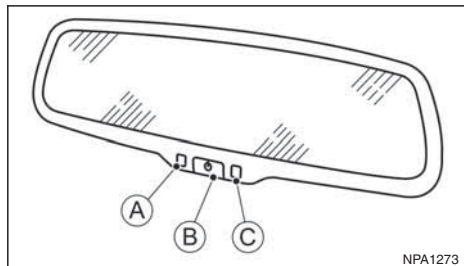

The inside mirror is designed so that it automatically adjusts the reflection according to the intensity of the following vehicle's headlights on the sensor (C).

The automatic anti-dazzling inside mirror will operate when the ignition switch is in the Acc or ON position. The light (A) shows the system is activated.

The automatic anti-dazzling inside mirror can be deactivated by pressing the power button (B). The light (A) will turn off to show system deactivation.

CAUTION

Do not cover the sensor, hang any object on the mirror or spray glass cleaner directly on the mirror. Doing so will reduce the sensitivity of the sensor, resulting in improper operation.

OUTSIDE REAR-VIEW MIRRORS



- Check the position of all mirrors before driving. Altering their position while driving could distract your attention from the driving operation.
- Objects viewed in the outside mirrors are closer than they appear.
- Never touch the outside rear-view mirrors while they are in motion. Doing so may pinch your fingers or damage the mirror.
- Never drive the vehicle with the outside rear-view mirrors folded. This reduces rear view visibility and may lead to an accident.

تلفن شبانه روزی: ۰۲۱-۸۸۶۲۰۸۵

FarmaSOS.com

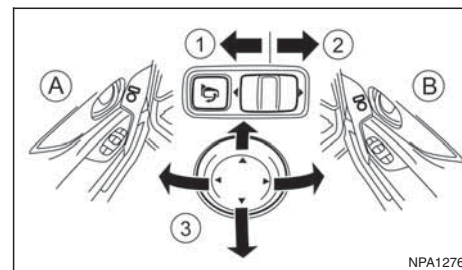

Adjusting — Remote control

(A) LHD models

(B) RHD models

Slide the control to the left (1) or to the right (2) to select the left or right outside rear-view mirror, then adjust the mirror to the desired position by pushing the control as illustrated (3).

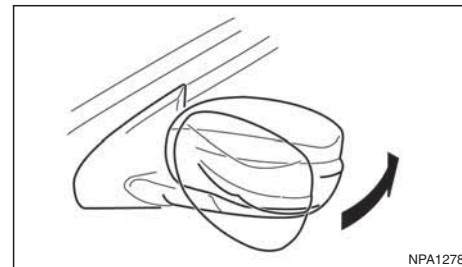

Folding — Manual control

Fold the outside rear-view mirror by pushing it towards the rear of the vehicle.

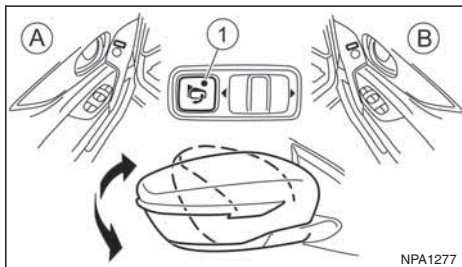

(A) LHD models

(B) RHD models

Folding — Remote control (where fitted)

The outside rear-view mirrors automatically fold when the outside rear-view mirror folding button ① is pressed. To unfold, push the button again.

NOTE

If the mirror becomes displaced from its adjusted position, use the following procedure to return it to the correct geared position:

1. Fold the mirrors electronically using the outside rear-view mirror folding button.
2. Wait until the mirror emits a strong noise, this confirms that the mirror has correctly engaged.

3. Fold out the mirrors electronically using the outside rear-view mirror folding button.

4. Adjust the mirror to the correct driving angle using the remote control, see -19.

VANITY MIRROR

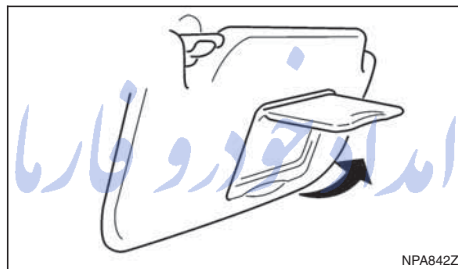

Left hand drive

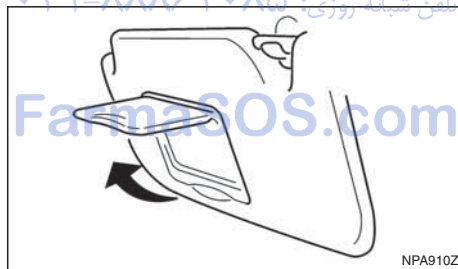

Right hand drive

To use the front vanity mirror, pull down the sun visor and lift up the cover.

4 Display screen, heater and air conditioner, and audio system

Safety precautions	4-2	Audio operation precautions	4-23
Rear-view monitor (where fitted).....	4-2	Antenna.....	4-23
How to read the displayed lines	4-3	FM AM radio with CD player (where fitted)	4-24
Rear-view monitor setting.....	4-3	Audio main operation	4-25
Operating tips.....	4-3	Radio operation	4-25
Around View Monitor (where fitted)	4-4	SETUP button	4-26
Operation	4-7	Compact Disc (CD) operation	4-28
Guide lines	4-7	AUX socket	4-30
Difference between predictive and actual distances.....	4-9	USB Memory operation (where fitted)	4-30
Moving object detection (MOD)	4-12	iPod® player operation (where fitted)	4-31
How to adjust the screen view	4-13	Bluetooth® operation.....	4-32
Around View Monitor settings	4-13	NissanConnect (where fitted).....	4-38
Operating tips.....	4-13	Steering wheel switch for audio control (where fitted).....	4-38
Vents.....	4-14	Main operation.....	4-38
Side and centre vents	4-14	Mobile phone integration for FM AM radio with CD player (where fitted).....	4-39
Heater and air conditioner operation	4-15	Bluetooth® mobile phone feature.....	4-39
Manual air conditioner.....	4-16	Hands-free telephone control	4-42
Automatic dual zone air conditioner (where fitted).....	4-20	Steering wheel switches (where fitted).....	4-44
Audio system	4-23	Car phone or CB radio	4-45

SAFETY PRECAUTIONS



WARNING

- Do not adjust the heater and air conditioner controls or audio controls while driving so that full attention may be given to vehicle operation.
- If you noticed any foreign objects entering the system hardware, spilled liquid on the system, or noticed smoke or fumes coming out from the system, or any other unusual operation is observed, stop using the system immediately and contact the nearest NISSAN dealer or qualified workshop. Ignoring such conditions may lead to an accident, fire or electric shock.
- Do not disassemble or modify this system. If you do, it may lead to an accident, fire, or electric shock.

CAUTION

Do not use the system when the engine is not running for extended periods of time to prevent battery discharge.

REAR-VIEW MONITOR (where fitted)

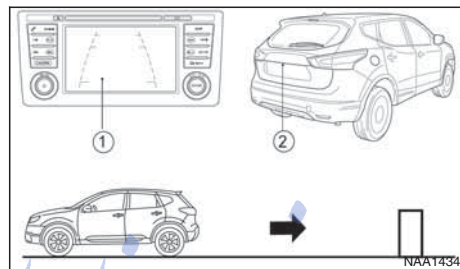

- ① Display
- ② Camera

When the shift lever is moved into the R (Reverse) position, the monitor (NissanConnect display) shows the view from the rear of the vehicle. The system is designed as an aid to the driver in detecting large stationary objects. It is intended to help avoid damaging the vehicle when reversing. However, the system will not detect small objects below the bumper and may not detect objects close to the bumper or on the ground.



WARNING

- The rear-view camera is a convenience but it is not a substitute for proper reversing. Always turn your head and visually check that the manoeuvre is safe to do so before reversing. Always reverse slowly.
- The distance from the objects viewed in the rear-view monitor differs from actual distance

because of the use of wide-angle lens. Objects in the rear-view monitor will appear visually reversed compared to those viewed in the inside and outside mirrors.

- Make sure that the back door is securely closed when reversing.
- The area below the bumper and corner areas of the bumper cannot be viewed on the rear-view monitor because of its monitoring range limitation.
- Do not put anything on the rear-view camera. The rear-view camera is installed above the number plate.
- When washing the vehicle with high pressure water, be sure not to spray it around the camera. Otherwise, water may enter the camera unit causing possibly water condensation on the lens, a malfunction, a fire or an electric shock.
- Do not strike the camera. It is a precision instrument. Otherwise, it may malfunction or cause damage resulting in a fire or an electric shock.

CAUTION

There is a transparent cover over the camera lens. Do not scratch the cover when cleaning dirt or snow from it.

HOW TO READ THE DISPLAYED LINES

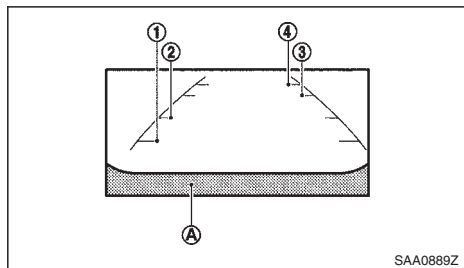

WARNING

- Use the displayed lines as a reference. The lines are highly affected by the number of occupants, fuel level, vehicle position, road condition and road grade. Always check with your eyes directly around the vehicle while reversing.
- The distance guide line and the vehicle width line should be used as a reference only when the vehicle is on a level paved surface. The distance viewed on the monitor is for reference only and may be different than the actual distance between the vehicle and displayed objects.
- When reversing the vehicle up a hill, objects viewed in the monitor are further than they appear. When reversing the vehicle down a hill, objects viewed in the monitor are closer

than they appear. Use the inside mirror or glance over your shoulder to properly judge distances to other objects.

The lines which are displayed on the monitor, indicate the vehicle's clearance and distance between the obstacle and the bumper (A).

Displayed lines indicate the distances between the obstacle and the bumper as follows:

- ① 0.5 m (1.5 ft) – red
- ② 1 m (3 ft) – yellow
- ③ 2 m (7 ft) – green
- ④ 3 m (10 ft) – green

NOTE

- The vehicle clearance lines are wider than the actual clearance.
- The lines are indicated as reference distances to the obstacle.

REAR-VIEW MONITOR SETTING

For details, see the separately provided NissanConnect Owner's Manual.

OPERATING TIPS

- When the shift lever is shifted to R (Reverse), the NissanConnect display automatically changes to the rear-view monitor mode.
- When the shift lever is returned to a position other than R (Reverse), it may take some time

until the screen changes. Objects on the screen may be distorted until they are completely displayed.

- When the temperature is extremely high or low, the screen may not clearly display objects. This is not a malfunction.
- When strong light directly enters the camera lens, objects may not be displayed clearly. This is not a malfunction.
- Vertical lines may be seen in objects on the screen. This is due to strong reflected light from the bumper. This is not a malfunction.
- The screen may flicker under fluorescent light. This is not a malfunction.
- The colours of objects on the rear-view monitor may differ somewhat from those of the actual object.
- Objects on the monitor may not be clear in a dark place or at night.
- If dirt, rain or snow attaches to the transparent camera cover, the rear-view monitor may not clearly display objects. Clean the transparent camera cover.
- Do not use alcohol, benzine or thinner to clean the transparent camera cover. This will cause discoloration. To clean the transparent camera cover, wipe with a cloth dampened with diluted mild cleaning agent and then wipe with a dry cloth.

AROUND VIEW MONITOR (where fitted)

- Do not damage the transparent camera cover as the NissanConnect display may be adversely affected.
- Do not use body wax on the transparent camera cover. Wipe off any wax with a clean cloth dampened with mild detergent diluted with water.

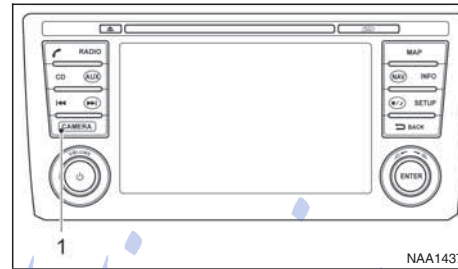

Camera button

NAA1437

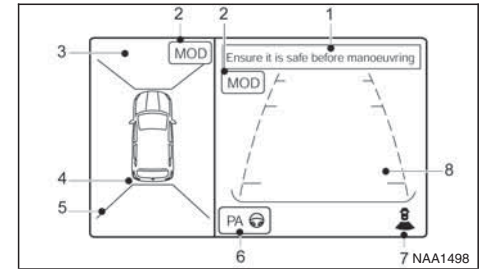

Right Hand Drive

NAA1498

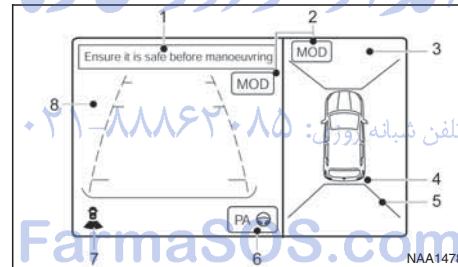

Left Hand Drive

NAA1478

- ① Message area
- ② [MOD] indicator*
- ③ Bird's-eye view or side view
- ④ Parking sensors
- ⑤ Corner indication
- ⑥ [PA] switch**
- ⑦ Front or rear view indicator

Bird's-eye view or front-side view

** For more information, see "Intelligent Parking Assist (IPA) (where fitted)" in the "5. Starting and driving" section.

Designs and items displayed on the screen may vary depending on the country and model.

With the ignition switch in the ON position, push the <CAMERA> button or move the shift lever to the R (Reverse) position to operate the Around View Monitor. The monitor displays various views around the vehicle.

NOTE

At first operation, the corner lines are blinking yellow for about 3 seconds. This is not a malfunction but a reminder to be cautious.

Available views:

- Bird's-eye View

The surrounding view of the vehicle.

- Front-side View

The view around and ahead of the front passenger's side wheel.

- Front view

The view to the front of the vehicle.

- Rear view

The view to the rear of the vehicle.

- Full screen rear view

The view to the rear of the vehicle (which is a little wider than the standard rear view)

The system is designed as an aid to the driver in situations such as slot parking or parallel parking.



There are some areas where the system will not show objects. When in the front or the rear view display, an object below the bumper or on the ground may not be viewed ①. When in the bird-eye view, a tall object near the seam ③ of the camera viewing areas will not appear in the monitor ②.



WARNING

- The Around View Monitor is intended for day time use. Do not use the system in bad light conditions.
- The Around View Monitor is a convenience feature. It is not a substitute for proper vehicle operation because it has areas where objects cannot be viewed. The four corners of the vehicle in particular, are blind spots where objects do not appear in the bird's-eye, front or rear views. Always look out the windows and check to be sure that it is safe to move. The driver is always responsible for safety during parking and other manoeuvres.
- Do not use the Around View Monitor with the outside mirror in the stored position, and make sure that the back door is securely closed when operating the vehicle using the Around View Monitor.
- The distance between objects viewed on the Around View Monitor differs from the actual distance.
- The cameras are installed on the front grille, the outside mirrors and above the rear number plate. Do not put anything on the cameras.
- When washing the vehicle with high-pressure water, be sure not to spray it around the cameras. Otherwise, water may enter the camera unit causing water condensation on the lens, a malfunction, fire or an electric shock.

- Do not strike the cameras. They are precision instruments. Doing so could cause a malfunction or cause damage resulting in a fire or an electric shock.

CAUTION

Do not scratch the lens when cleaning dirt or snow from the front of the camera.

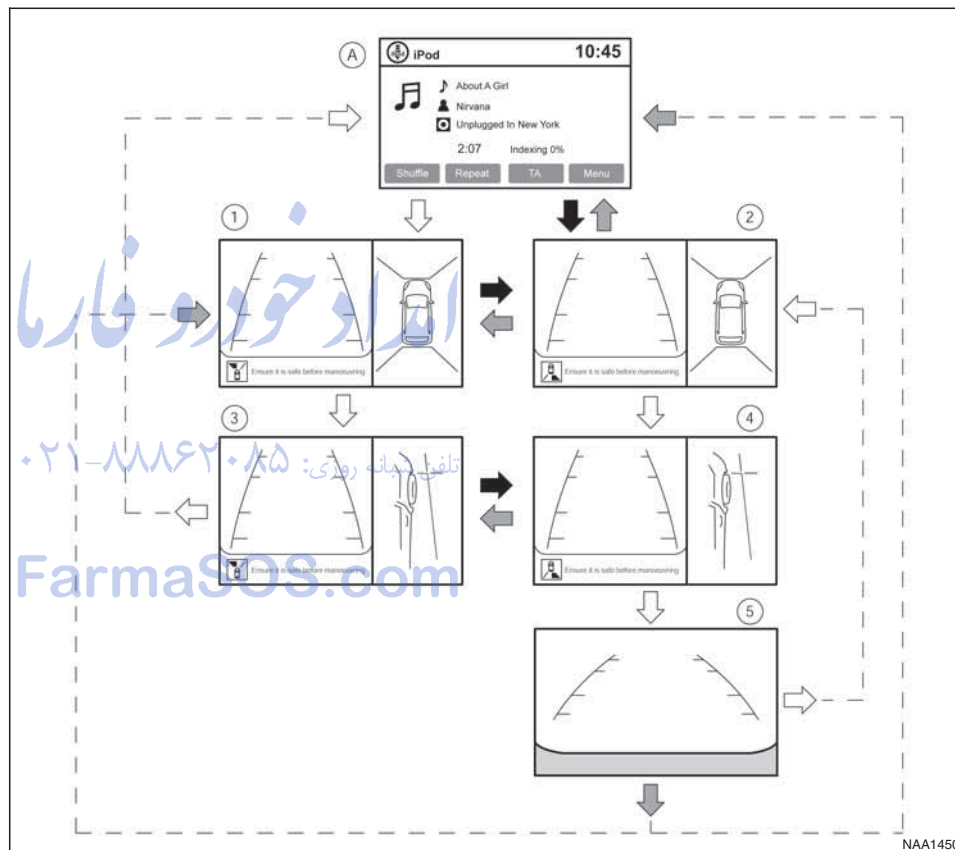

Example for Left-Hand Drive (LHD) models, for the Right-Hand Drive (RHD) models, the screen layout will be opposite.

OPERATION

The Around View Monitor display consists of the front, left, right and rear screens. You can see a combination of different views on the screens as illustrated.

Ⓐ: Audio or navigation screen before the Around View Monitor is operated.

①: Front view and bird's-eye view

②: Rear view and bird's-eye view

③: Front view and front side view

④: Rear view and front side view

⑤: Rear view

➡: Shift lever into R (Reverse)

⏪: Shift lever out of R (Reverse)

⏪: Push the <CAMERA> button

The Around View monitor starts if:

- R (Reverse) gear is selected
- The <CAMERA> button is pushed
- The front parking sensors (where fitted) detect an object.

Starting with the shift lever operation

- When the shift lever is shifted into the R (Reverse) position Around View Monitor starts automatically and the rear view and bird's-eye view are displayed ②.

- When the shift lever is shifted out of the R (Reverse) position Ⓐ, the monitor changes from Around View Monitor screen to the audio or navigation screen.

- In R (Reverse) gear, the rear view and bird's-eye view ② are shown. The passenger's side view on the monitor changes to the front side view ④ when the <CAMERA> button is pushed.

Push the <CAMERA> button again change to Rear View ⑤. When the shift lever is shifted out of the R (Reverse), the screen changes to before reversing screen.

Push the <CAMERA> button from ⑤ to change back to rear view and bird's-eye view ②.

Starting with the CAMERA button operation

- When the <CAMERA> button is pushed, Around View Monitor operates and the front view and bird's-eye view are displayed ①.

- The front view and bird's-eye view are displayed ①. When the <CAMERA> button is pushed again ③, the view on the screen on the passenger's side changes to the front-side view. Pushing the <CAMERA> button again turns the Around View Monitor off.

- To change the driver's side screen between front view and rear view use the shift lever.
- When the shift lever is not in the R (Reverse) position and the vehicle speed increases above

approximately 10 km/h (6 MPH), the monitor changes from Around View Monitor screen to the audio or navigation screen.

GUIDE LINES



WARNING

- The distance guide line and the vehicle width line should be used as a reference only when the vehicle is on a paved, level surface. The distance viewed on the monitor is for reference only and may be different than the actual distance between the vehicle and displayed objects.
- Use the displayed lines and the bird-eye view as a reference. The lines and the bird-eye view are greatly affected by the number of occupants, fuel level, vehicle position, road condition and road grade.
- If the tyres are replaced with different sized tyres, the predictive course line and the bird-eye view may be displayed incorrectly.
- When driving the vehicle up a hill, objects viewed in the monitor are further than they appear. When driving the vehicle down a hill, objects viewed in the monitor are closer than they appear. Use the mirrors or actually look to properly judge distances to other objects.

The vehicle width and predictive course lines are wider than the actual width and course.

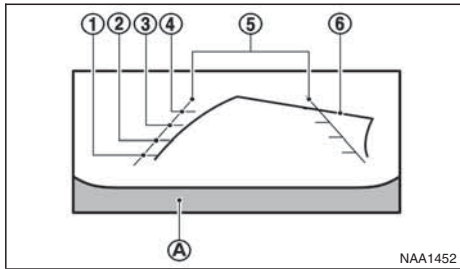

Example

Guiding lines

Guiding lines, which indicate the vehicle width and distances to objects with reference to the vehicle body line (A), are displayed on the monitor.

Distance guide lines:

Indicate distances from the vehicle body.

- Red line ①: approx. 0.5 m (1.5 ft)
- Yellow line ②: approx. 1 m (3 ft)
- Green line ③: approx. 2 m (7 ft)
- Green line ④: approx. 3 m (10 ft)

Vehicle width guide lines and static predictive course lines ⑤:

Indicate the vehicle width when reversing.

Dynamic predictive course lines ⑥:

The dynamic predictive course lines will be displayed on the monitor when the steering wheel is turned. The course lines will move depending on

how much the steering wheel is turned and will not be displayed while the steering wheel is in the straight ahead position.

The front view will not be displayed when the vehicle speed is above approximately 30 km/h (20 MPH).

WARNING

- Objects in the monitor will appear visually opposite than when viewed in the rear view and outside mirrors.
- On a snow-covered or slippery road, there may be a difference between the predictive course line and the actual course line.
- The displayed lines on the rear view will appear slightly off to the right because the rear view camera is not installed in the rear centre of the vehicle.

NOTE

When the monitor displays the front view and the steering wheel turns about 90 degrees or less from the neutral position, both the right and left predictive course lines ⑥ are displayed. When the steering wheel turns about 90 degrees or more, a line is displayed only on the opposite side of the turn.

Bird-eye view

WARNING

- Objects in the bird-eye view will appear further than the actual distance because the

bird-eye view is a pseudo view that is processed by combining the views from the cameras on the outside mirrors, the front and the rear of the vehicle.

- Tall objects, such as a kerb or a vehicle, may be misaligned or not displayed at the seam of the views.
- Objects that are above the camera cannot be displayed.
- The view for the bird-eye view may be misaligned when the camera position alters.
- A line on the ground may be misaligned and is not seen as being straight at the seam of the views. The misalignment will increase as the line proceeds away from the vehicle.

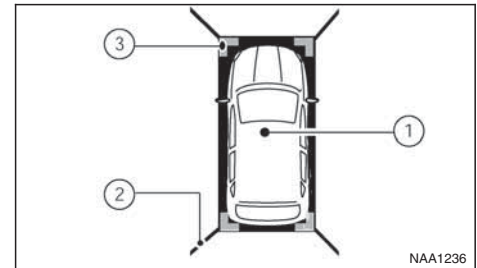

The bird-eye view shows the overhead view of the vehicle, which helps confirm the vehicle position and the predicted course to a parking space.

The vehicle icon ① shows the position of the vehicle.

NOTE

The size of the vehicle icon on the bird-eye view may differ somewhat from the actual vehicle.

At first operation, the blind spot corner lines ② on all four corners of the vehicle icon are blinking yellow for about 3 seconds. The four corners ③ of the vehicle are displayed in red if parking sensor is not fitted, or is turned off.

NOTE

- The areas that the cameras cannot cover are indicated in black.
- Blind spot corner lines ② blink (yellow) on all four corners of the vehicle icon as a reminder to be cautious. This is not a malfunction.

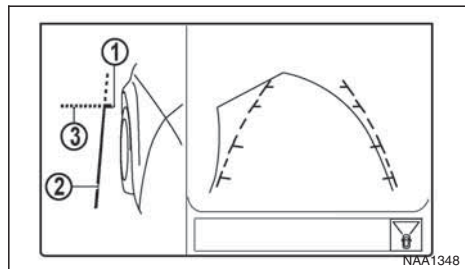

Front-side view, Left-Hand Drive (LHD) models*

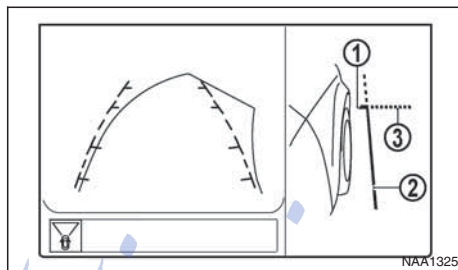

Front-side view, Left-Hand Drive (LHD) models*

Front-side view

*: For the Right-Hand Drive (RHD) models, the screen layout will be shown opposite.

Guiding lines:

CAUTION

The actual distance to objects may differ from the distance shown.

Guiding lines that indicate the width and the front end of the vehicle are displayed on the monitor.

The front-of-vehicle line ① shows the front part of the vehicle.

The side-of-vehicle line ② shows the vehicle width including the outside mirror.

The extensions ③ of both the front ① and side ② lines are shown with a green dotted line.

DIFFERENCE BETWEEN PREDICTIVE AND ACTUAL DISTANCES



WARNING

The distance guide line and the vehicle width guide line on the front and the rear view should be used as a reference only when the vehicle is on a level, paved surface. The distance viewed on the monitor is for reference only and may be different than the actual distance between the vehicle and displayed objects.

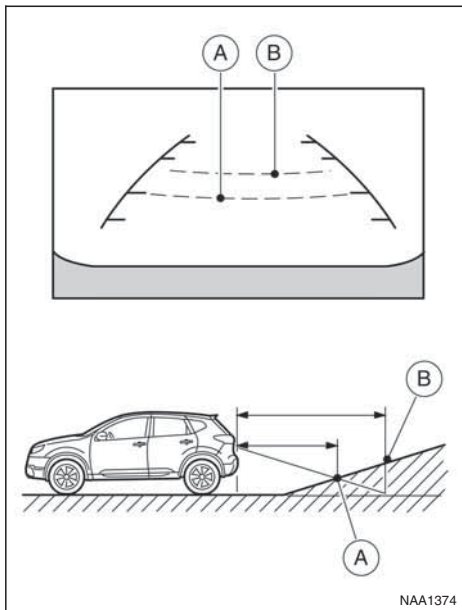

Moving to a steep uphill

When moving the vehicle up a hill, the distance guide lines and the vehicle width guide lines are shown closer than the actual distance. For example, the display shows 1 m (3 ft) to the place (A), but the actual 1 m (3 ft) distance on the hill is the place (B). Note that any object on the hill is viewed in the monitor further than it appears.

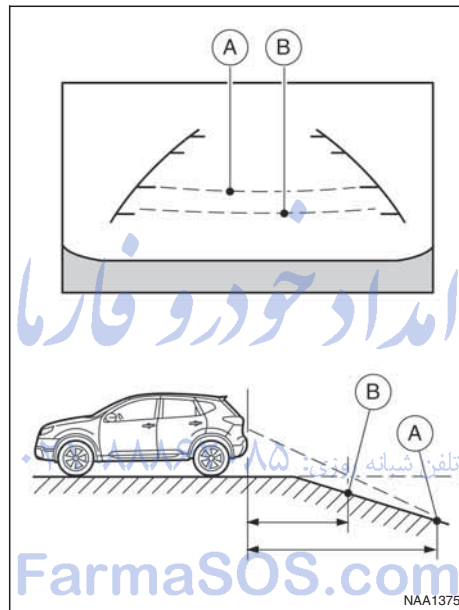

Moving to a steep downhill

When moving the vehicle down a hill, the distance guide lines and the vehicle width guide lines are shown further than the actual distance. For example, the display shows 1 m (3 ft) to the place (A), but the actual 1 m (3 ft) distance on the hill is the place (B). Note that any object on the hill is viewed in the monitor closer than it appears.

Moving near a projecting object

The dynamic predictive course lines (A) may show that the vehicle is not touching the object. However, the vehicle may hit the object if it projects over the actual moving course.



WARNING

The distance viewed on the monitor is for reference only and may be different than the actual distance between the vehicle and displayed objects.

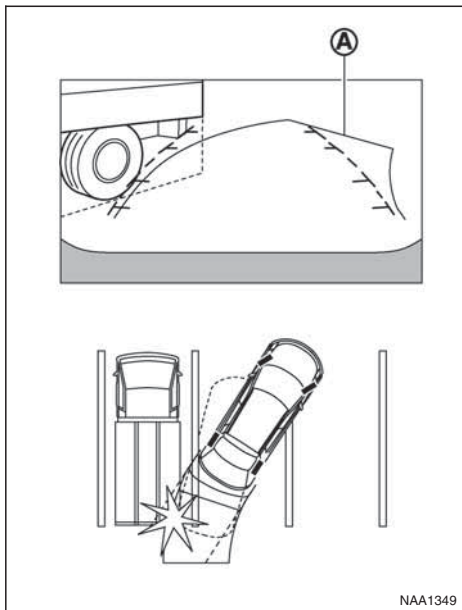

The predictive course lines (A) do not touch the object in the display. However, the vehicle may hit the object if it projects over the actual moving course.



There may be a small visible distance between the vehicle and the object in the bird's-eye view (B) on the monitor.

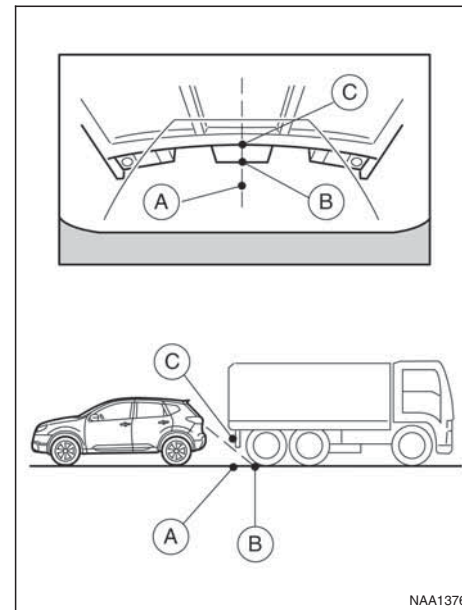

Moving closer to a projecting object

The position (C) is shown further than the position (B) in the display. However, the position (C) is actually at the same distance as the position (A). The vehicle may hit the object when moving toward the position (A) if the object projects over the actual moving course.

MOVING OBJECT DETECTION (MOD)

The Moving Object Detection (MOD) system can inform the driver of the moving objects surrounding the vehicle.

The MOD system detects moving objects by using image processing technology on the image shown on the Around View Monitor display.

The MOD system operates in the following conditions when the camera view is displayed:

- When the shift lever is in the N (Neutral) position (XTRONIC and MT models) or P (Park) position (XTRONIC models) and the vehicle is stopped, the MOD system detects the moving objects in the bird-eye view.
- When the shift lever is in the any position other than R (Reverse) position and the vehicle speed is above 0 km/h and below approximately 8 km/h (5 MPH), the MOD system detects moving objects in the front view.
- When the shift lever is in the R (Reverse) position and the vehicle speed is below approximately 8 km/h (5 MPH), the MOD system detects moving objects in the rear view. The MOD system will not operate correctly if the back door is open.

The MOD icon will change to blue to show which view is currently active.

The MOD system does not detect moving objects in the front-side view. The MOD icon is not displayed on the screen when in this view.

WARNING

- **The MOD system is not a substitute for proper vehicle operation and is not designed to prevent contact with the objects surrounding the vehicle. When manoeuvring, always use the outside mirror and rear view mirror and turn and check the surroundings to ensure it is safe to manoeuvre.**
- **The MOD system does not have the function to detect the surrounding stationary objects.**

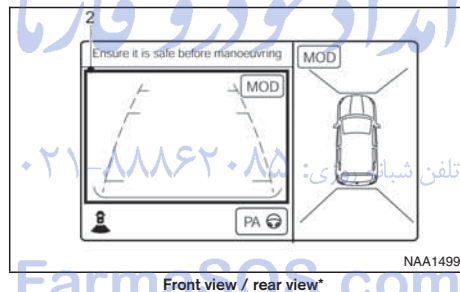

*: For the Right-Hand Drive (RHD) model, the screen layout will be opposite.

When the MOD system detects a moving object surrounding the vehicle, the yellow frame will be displayed on the view where the objects are detected and a chime will sound once. While the MOD system continues to detect moving objects, the yellow frame continues to be displayed.

The yellow frame ② is displayed on each view in the front view, front-wide view, rear view and rear-wide view modes.

A blue MOD icon is displayed in the view where the MOD system is operative. A grey MOD icon is displayed in the view where the MOD system is not operative.

WARNING

- **Do not use the MOD system when towing a trailer (if available). The system may not function properly.**
- **Excessive noise (for example, audio system volume or open vehicle window) will interfere with the chime sound, and it may not be heard.**
- **The MOD system performance will be limited according to environmental conditions and surrounding objects such as:**
 - When there is low contrast between background and the moving objects.
 - When there is blinking source of light.
 - When strong light such as another vehicle's headlight or sunlight is present.
 - When camera orientation is not in its usual position, such as when mirror is folded.
 - When there is dirt, water drops or snow on the camera lens.
 - When the position of the moving objects in the display is not changed.

- The MOD system might detect flowing water droplets on the camera lens, white smoke from the exhaust, moving shadows, etc.
- The MOD system may not function properly depending on the speed, direction, distance or shape of the moving objects.
- If your vehicle sustains damage to the parts where the camera is installed, leaving it misaligned or bent, the sensing zone may be altered and the MOD system may not detect objects properly.
- When the temperature is extremely high or low, the screen may not display objects clearly. This is not a malfunction.

Camera maintenance

If dirt, rain or snow accumulates on the camera, the MOD system may not operate properly. Clean the camera.

HOW TO ADJUST THE SCREEN VIEW

To adjust the display brightness of the Around View Monitor, use the settings described in the separately provided NissanConnect owner's manual.

Do not adjust the settings while the vehicle is moving. Make sure the parking brake is firmly applied.

AROUND VIEW MONITOR SETTINGS

To switch the Moving Object Detection between on or off, proceed as follows:

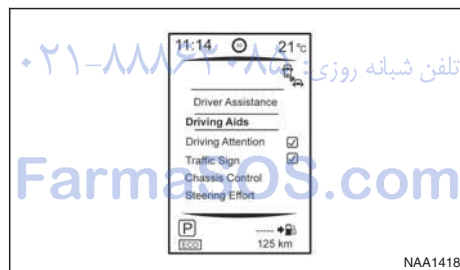
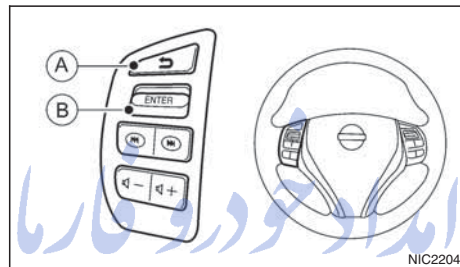

- 1) Press the steering wheel button to enter the vehicle information display, see "Vehicle information display" in the "2. Instruments and controls" section.

- 2) Select the [Settings] key using the steering wheel switch. Scroll by push up or down button (B), select by pressing button (A).
- 3) Select the [Driving Aids] key.
- 4) Select the [Parking Aids] key.
- 5) Select the [Moving Objects Detection] key to switch between on or off. If a marker is shown the item is switched on.

View malfunction

When the [!] icon is displayed on the screen, there will be abnormal conditions in the Around View Monitor. This will not hinder normal driving operation but the system should be inspected by a NISSAN dealer or qualified workshop.

When the [X] icon is displayed on the screen, the camera image may be receiving temporary electronic disturbances from surrounding devices. This will not hinder normal driving operation but the system should be inspected by a NISSAN dealer or qualified workshop if it occurs frequently.

OPERATING TIPS

- When the view is switched, the display images on the screen may be displayed with some delay.
- When the temperature is extremely high or low, the screen may not display objects clearly. This is not a malfunction.

VENTS

- When strong light shines directly on to the camera, objects may not be displayed clearly. This is not a malfunction.
- The screen may flicker under fluorescent light. This is not a malfunction.
- The colours of objects on the Around View Monitor may differ somewhat from the actual colour of objects. This is not a malfunction.
- Objects on the monitor may not be clear and the colour of the object may differ in a dark environment. This is not a malfunction.
- There may be differences in sharpness between each camera view of the bird-eye view.
- If dirt, rain or snow accumulates on the camera, the Around View Monitor may not display objects clearly. Clean the camera.
- Do not use alcohol, benzine or thinner to clean the camera. This will cause discoloration. To clean the camera, wipe with a cloth that has been dampened with a diluted mild cleaning agent and then wipe with a dry cloth.
- Do not damage the camera because the monitor screen may be adversely affected.
- Do not use wax on the camera lens. Wipe off any wax with a clean cloth that has been dampened with a mild detergent diluted with water.

SIDE AND CENTRE VENTS

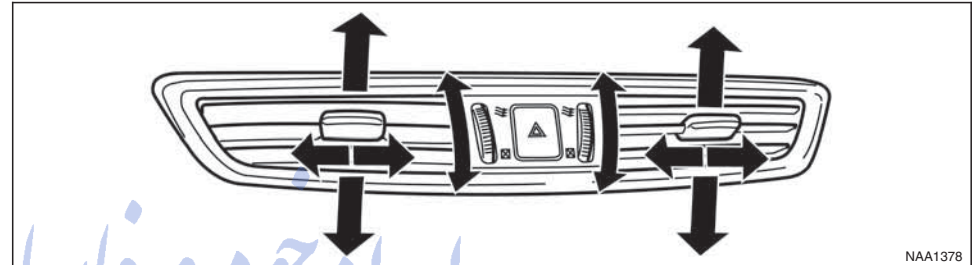

امداد خودرو فارما
این نماد زردی نشان می‌دهد که دریچه‌ها بسته است. حرکت دادن کنترل کناره به این موقعیت دریچه‌ها را می‌بندد.

☒ : This symbol indicates that the vents are closed. Moving the side control to this position will close the vents.

Adjust the air flow direction of the vents by moving the centre knob (up/down, left/right) until the desired position is achieved.

FarmaSOS.com

HEATER AND AIR CONDITIONER OPERATION

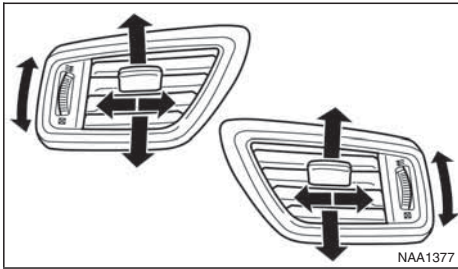

Side vents

☒ : This symbol indicates that the vents are closed. Moving the side control to this position will close the vents.

Adjust the air flow direction of the vents by moving the centre knob (up/down, left/right) until the desired position is achieved.

WARNING

- Do not leave children or adults who would normally require the support of others alone in your vehicle. Pets should not be left alone either. On hot, sunny days, temperatures in a closed vehicle could quickly become high enough to cause severe or possibly fatal injuries to people or animals.
- Do not use the recirculation mode for long periods as it may cause the interior air to become stale and the windows to fog up. It is recommended that you use the outside air mode in cold weather to keep the windows clear.
- Do not adjust the positioning of the heating/ventilation or air conditioning controls while driving.

NOTE

- Condensation forms inside the air conditioning unit when the air conditioner is running, and is safely discharged underneath your vehicle.

Traces of water on the ground are therefore normal.

- Models with Stop/Start System:

Whilst the engine is stopped by the Stop/Start System, selecting airflow to the front defogger will cause the engine to be automatically restarted.

Whilst the engine is running, selecting airflow to the front defogger will prevent the Stop/Start System automatically stopping the engine.

The Stop/Start System will prevent unnecessary fuel consumption and exhaust emissions. When the engine is stopped by the Stop/Start System heater and air conditioner performance may be reduced. To keep full heater and air conditioner performance, restart the engine by pressing the Stop/Start System OFF switch, or by turning the ignition switch.

For more information on the Stop/Start System, see “Stop/Start System (where fitted)” in the “5. Starting and driving” section.

- Odours from inside and outside the vehicle can build up inside the air conditioner unit and it can enter the passenger compartment through the vents.
- When parking, set the air recirculation mode to off to allow fresh air flowing into the passenger compartment. This should help reducing the odours inside the vehicle.

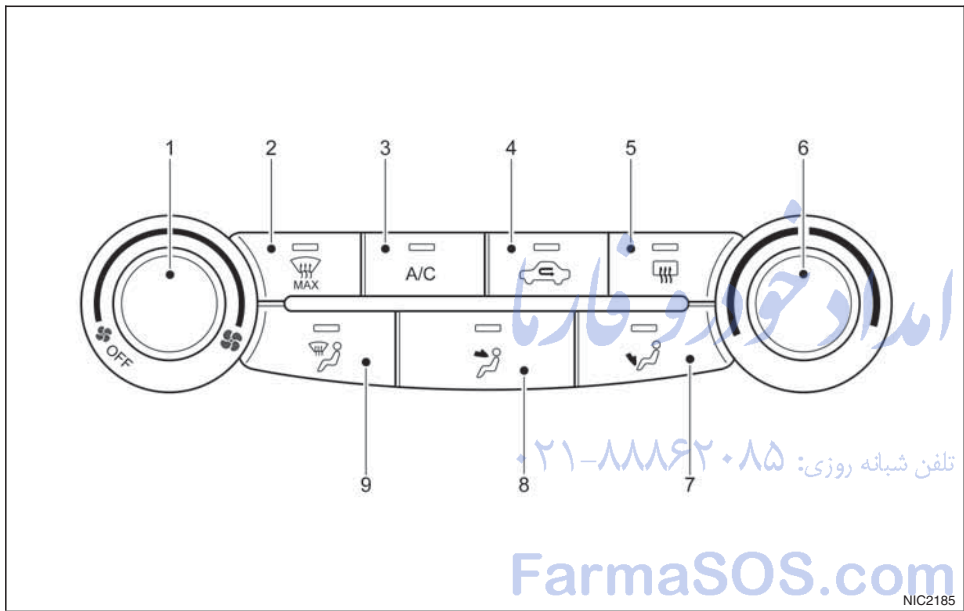

Manual air conditioner

MANUAL AIR CONDITIONER

- | | |
|--|---|
| <ul style="list-style-type: none"> ① Fan speed control dial ② Windscreen defogger MAX button ③ Air conditioner ON/OFF button ④ Air recirculation button ⑤ Rear window defogger button | <p>(For details, see “Defogger switch” in the “2. Instruments and controls” section)</p> <ul style="list-style-type: none"> ⑥ Temperature control dial ⑦ Floor outlets airflow selection button ⑧ Centre and side vent outlets airflow selection button ⑨ Windscreen outlets airflow selection button |
|--|---|

Controls

Fan speed control dial :

To switch the fan on or off and to control the fan speed, turn the fan speed control dial clockwise to increase the fan speed. To decrease the fan speed, turn the fan speed control dial anticlockwise.

Turning the dial completely anticlockwise turns off the fan.

Temperature control dial:

Turn the temperature control dial to set the desired air temperature from the vents and floor outlets.

Air flow control buttons:

Use these buttons to manually select the air flow from the air outlets as described below:

: Air flows mainly from the windscreen defogger outlets.

: Air flows from centre and side vents.

: Air flows mainly from floor outlets.

Air recirculation button :

Outside air circulation

- Press the air recirculation () button to the “OFF” position to draw outside air into the passenger compartment (the indicator light goes off). Use the “OFF” position for normal heating ventilation, or air conditioner (where fitted) operation.

● Air recirculation

Press the air recirculation () button to the "ON" position (the indicator light goes on). Use the "ON" position in situations such as: driving on a dust raised road, avoiding traffic fumes or having maximum cooling from the air conditioner (where fitted).

If the windows fog up, switch on the air conditioning (where fitted).

A/C (Air Conditioner) button (where fitted):





Press the A/C button to turn the air conditioner on or off. When the air conditioner is on, the A/C indicator light illuminates.





Operation

The heater and air conditioner operate when the engine is running. The air blower will operate even if the engine is turned off and the ignition switch is in the ON position.



NOTE

The air conditioner cooling function operates only when the engine is running and the fan is activated.

1. Press the air recirculation () button to the "OFF" position.
2. Use the airflow control buttons for:
 - **Cooling:** select the  or  setting.
 - **Heating:** select the  or  setting.

- **Heating and defogging:** select the  setting.
 - **Ventilation:** select the  or  setting.
 - **Windscreen defogging:** select the  setting.
3. Set the fan speed to the desired position.
 4. Turn the temperature control dial to the desired position.

NOTE

When selecting the  or  setting, turn the temperature control dial to the desired position between the middle and the maximum "HOT" (right) position.

5. Press the A/C button (where fitted) to the "ON" position and the indicator light will come on. Switch this mode on for dehumidified heating or cooling.

NOTE



- The air conditioner mode is used to cool and dehumidify. For quick cooling when the outside temperature is high, select the air recirculation mode position (). Be sure to return to the outside air mode to avoid windows from fogging-up and interior air from becoming stale.

A visible mist may be seen coming from the vents in hot, humid conditions as the air is cooled rapidly this is not a malfunction.

- For quick heating, press the air recirculation () button to the "ON" position. Be sure to return to the "OFF" position for normal heating (no indicator light) in order to avoid window fog and stale interior.

Windscreen defogger (manual mode):

Use this mode for defogging the windscreen as follows:

1. Press the  button.
The system will set the fan speed to maximum. Air circulation is cancelled, the airflow mode  and the air conditioner is activated automatically. Air flows mainly from the defogger outlets.
2. Set the temperature control dial to the maximum (HOT) position.
3. To switch off, press the  button to return to the previous mode.

NOTE

- To quickly defrost/defog the windscreen, set the fan speed to the maximum position.
- As soon as possible after the windscreen has been cleared of ice or fog, press the windscreen defogger button.
- When the windscreen defogging mode is activated, the air conditioner will automatically switch on at outside temperatures above -2°C (28°F) and the air recirculation mode will be switched off.

Operating tips

- In order to improve the heater operation, clear any snow and ice from the wiper blade and air inlet in front of the windscreen.
- After parking in the sun, drive for two or three minutes with the windows open to vent hot air from the passenger compartment. Then close the windows to allow the acceleration of the air conditioner's cooling operation.
- Keep the windows closed while the air conditioner is operating.
- The air conditioning system should be operated for about 10 minutes, at least once a month. This helps prevent damage to the system due to lack of lubrication.
- If the coolant temperature gauge exceeds the "HOT" position, turn the air conditioner off. For additional information, see "Engine overheat" in the "6. In case of emergency" section.
- If the engine coolant reaches an extremely high temperature, the air conditioning system will automatically turn off. This may happen for example if the engine runs at idle speed for a long time on a hot day.

Quick reference charts

The following charts show the button, air intake and dial positions for **MAXIMUM AND QUICK** heating, cooling or defrosting.

NOTE

The air recirculation mode should not be selected for either normal heating or defrosting.

امداد خودرو فارما

تلفن شبانه روزی: ۰۲۱-۸۸۸۶۲۰۸۵

FarmaSOS.com

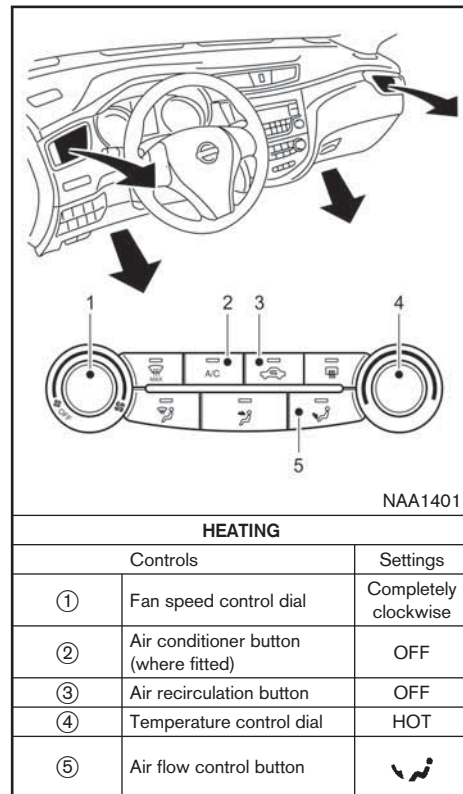

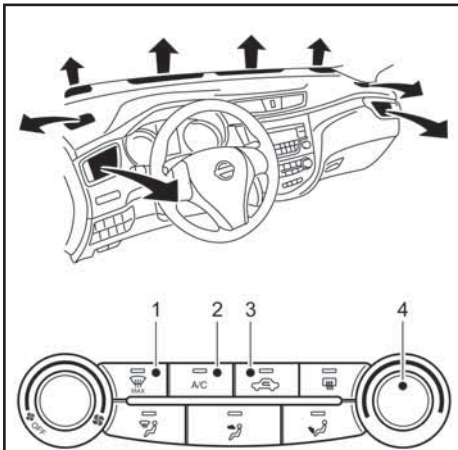

NAA1403

DEFROSTING/DEFOGGING

Controls		Settings
①	Defogger MAX button	ON
②	Air conditioner button	ON
③	Air recirculation button	OFF
④	Temperature control dial	Completely clockwise

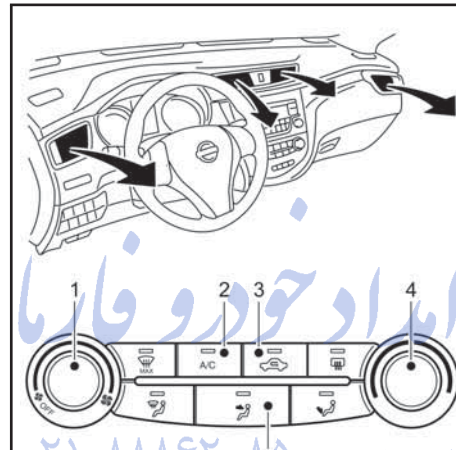

NAA1405

COOLING

Controls		Settings
①	Fan speed control dial	Completely clockwise
②	Air conditioner button (where fitted)	ON
③	Air recirculation button	ON (Max) OFF (Normal)
④	Temperature control dial	COLD
⑤	Air flow control button	

Air conditioner filter (where fitted)

The air conditioning system is equipped with a filter which collects dirt, pollen, dust, etc. To make sure the air conditioner heats, defogs, and ventilates efficiently, replace the filter regularly. For filter replacement, contact a NISSAN dealer or qualified workshop.

The filter should be replaced if the airflow is extremely reduced or when the windows fog up easily during air conditioning system operation.

Servicing air conditioner

The air conditioning system (where fitted) in your NISSAN vehicle is charged with an environmentally friendly refrigerant.



NISSAN Blue Citizenship

This refrigerant will not harm the earth's ozone layer.

Special charging equipment and lubricant are required when servicing your vehicle's air conditioner. Using improper refrigerants or lubricants will cause severe damage to the air conditioning system. See "Capacities and recommended fuel/lubricants" in the "9. Technical information" section of this manual.

A NISSAN dealer or qualified workshop will be able to service the air conditioning system.

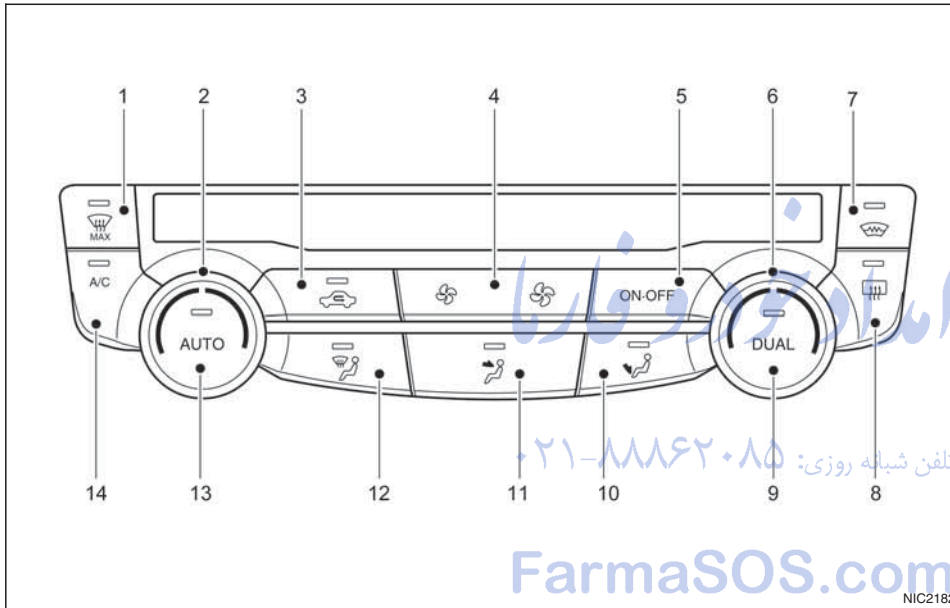

Automatic air conditioner with windscreen defogger (where fitted)

AUTOMATIC DUAL ZONE AIR CONDITIONER (where fitted)

- ① Windscreen defogger MAX button
- ② Temperature control dial (Driver's side (LHD)/ Passenger's side (RHD))
- ③ Air recirculation button

- ④ Fan speed control buttons
- ⑤ ON/OFF button
- ⑥ Temperature control dial (Driver's side (RHD)/ Passenger's side (LHD))
- ⑦ ThermaClear Heated Windscreen button (where fitted)

(For details, see "ThermaClear Heated

Windscreen button" in the "2. Instruments and controls" section)

- ⑧ Rear window defogger button
(For details, see "Defogger switch" in the "2. Instruments and controls" section)
- ⑨ Dual zone control ON/OFF button
- ⑩ Floor outlets airflow selection button
- ⑪ Centre and side vent outlets airflow selection button
- ⑫ Windscreen outlets airflow selection button
- ⑬ Automatic climate control button
- ⑭ Air conditioner ON/OFF button



WARNING

- Do not leave children or adults who would normally require the support of others alone in your vehicle. Pets should not be left alone either. On hot, sunny days, temperatures in a closed vehicle could quickly become high enough to cause severe or possibly fatal injuries to people or animals.
- Do not use the recirculation mode for long periods as it may cause the interior air to become stale and the windows to fog up. It is recommended that you use the outside air mode in cold weather to keep the windows clear.

- Do not adjust the positioning of the heating/ventilation or air conditioning controls while driving.

NOTE

- The air conditioner cooling function operates only when the engine is running, and the ambient temperature is above -2°C (28°F).
- The air conditioner can be used to dehumidify when heating, or to reduce air temperature and dehumidify when cooling. This is possible in both auto or manual control mode as long as the fan speed is at minimum (first bar) or higher.
- When the AUTO mode is selected, the temperature of the passenger compartment will be maintained automatically. Air flow distribution and fan speed will also be controlled automatically.

Controls

NOTE

Before any selection or change is made, press the AUTO button to activate the heater and air conditioner system.

Cooling and/or dehumidified heating (AUTO mode):

This mode may be used all year round. The system works automatically to control the inside temperature, air flow distribution and fan speed after the preferred temperature is set manually.

1. Press the AUTO button (the indicator light will illuminate).
2. Operate the driver's side temperature control dial to set the desired temperature.

Adjust the temperature to about 22°C (72°F) for normal operation.

3. Driver's side and passenger side temperatures can be set independently using the individual temperature control dial. When the passenger side temperature control dial is turned, the DUAL indicator light will come on. To turn off the passenger side temperature control, press the DUAL button.

NOTE

- A visible mist may be seen coming from the vents in hot, humid conditions as the air is cooled rapidly, this is not a malfunction.

Heating (AUTO mode):

Use this mode for heating purposes only.

1. Press the A/C button to turn off the air conditioner cooling function (A/C indicator light goes off).
 2. Select the desired temperature with the temperature control dial.
- Do not set the temperature at a lower level than the one of the outside air temperature. Otherwise the system may not work properly.
 - This mode is not recommended if the windscreen fogs up.

Airflow control buttons:

Use these buttons to manually select the air flow form these outlets as described below:



 : Air flows mainly from the windscreen defogger outlets.

 : Air flows from centre and side vents.

 : Air flows mainly from floor outlets.

Windscreen defogger (manual mode):

Use this mode for defogging the windscreen as follows:

1. Press the  button.
The system will set the fan speed to maximum. Air circulation is cancelled, the airflow mode  and the air conditioner is activated automatically. Air flows mainly from the defogger outlets.
2. To switch off, press the  button to return to the previous mode or the AUTO button for auto climate control mode.

NOTE

- To quickly defrost/defog the windscreen, set the fan speed to the maximum position.
- As soon as possible after the windscreen has been cleared of ice or fog, press either the windscreen defogger button or AUTO button.
- When the windscreen defogging mode is activated, the air conditioner will automatically switch on at outside temperatures above -2°C (28°F) and the air recirculation mode will be switched off.

Heating and defogging (Manual mode):

This mode heats the interior and defogs the windscreen.

Use the airflow control buttons to select the  button is pressed. Switch on the air-conditioning to improve the defogging and adjust the preferred fan speed and temperature.

Fan speed control (Manual mode):

Press the fan speed control buttons to adjust the fan speed.

Press the AUTO button to change the fan speed to automatic mode.

Air recirculation:



Use this mode to recirculate interior air inside the passenger compartment in situations such as driving on a dust raised road, avoiding traffic fumes or having maximum cooling from the air conditioner.

Press the  button to recirculate interior air. The indicator light illuminates and the air conditioner will automatically come on.

When the air recirculation mode is switched off, outside air is drawn into the passenger compartment.

Outside air circulation :

Use this mode to draw outside air into the passenger compartment for normal heating, ventilation or air conditioner operation.

Press the  button to change the air intake from the air recirculation to the outside air mode. The indicator light  turns off.

To turn the system on/off:

Press the "ON/OFF" button to turn the system on or off.

Operating tips

- In order to improve the heater operation, clear the snow and ice from the wiper blade and air inlet in front of the windscreen.
- When the engine coolant temperature and outside air temperature are low, the airflow from the floor outlets may not operate for a maximum of 150 seconds. However, this is not a malfunction. After the coolant temperature has warmed up, the airflow from the floor outlets will operate normally.
- After parking in the sun, drive for two or three minutes with the windows open to vent hot air from the passenger compartment. Then, close the windows. This will allow the acceleration of the air conditioner's cooling operation.
- Keep windows closed while the air conditioner is operating.
- The air conditioning system should be operated for about 10 minutes, at least once a month. This helps prevent damage to the system due to lack of lubrication.
- If the coolant temperature gauge exceeds the "HOT" position, turn the air conditioner off. For additional information, see "Engine overheat" in the "6. In case of emergency" section.

- If the engine coolant reaches an extremely high temperature, the air conditioning system will automatically turn off. This may happen for example if the engine runs at idle speed for a long time on a hot day.

Air conditioner filter

The air conditioning system is equipped with a filter which collects dirt, pollen, dust, etc. To make sure the air conditioner heats, defogs, and ventilates efficiently, replace the filter regularly. To replace the filter, contact a NISSAN dealer or qualified workshop.

The filter should be replaced if the airflow is extremely reduced or when the windows fog up easily while operating the heater or air conditioning system.

Servicing air conditioner

The air conditioning system in your NISSAN vehicle is charged with an environmentally friendly refrigerant.



NISSAN Blue Citizenship

This refrigerant will not harm the earth's ozone layer.

Special charging equipment and lubricant are required when servicing the NISSAN air conditioner. Using improper refrigerants or lubricants will cause severe damage to the air conditioning system. See "Capacities and recommended fuel/lubricants" in the "9. Technical information" section.

A NISSAN dealer or qualified workshop will be able to service the air conditioning system.

AUDIO SYSTEM



WARNING

Do not adjust the audio system while driving.

The audio system operates when the ignition switch is in the Acc or ON position. If you want to listen to the radio or CD while the engine is not running, turn the ignition switch to the Acc position. **Do not use for an extended period of time with the engine stopped.**

AUDIO OPERATION PRECAUTIONS

NOTE

Models with NissanConnect system, see the audio operation precautions in the separately provided NissanConnect Owner's Manual.

Radio

- Radio reception is affected by station signal strength, distance from radio transmitter, buildings, bridges, mountains and other external influences. Intermittent changes in reception quality are normally caused by these external influences.
- Using a mobile phone in or near the vehicle may influence radio reception quality.
- Use the antenna for the best reception.

Compact Disc (CD) player

- **During cold weather or rainy days, the player may malfunction due to the humidity. If this occurs, remove the CD and dehumidify or ventilate the player completely.**

- The player may skip while driving on rough roads.
- Occasionally, the CD player may not function when the compartment temperature is extremely high. **Decrease the temperature before use.**
- Do not expose the CD to direct sunlight.
- CDs that are of poor quality, dirty, scratched, covered with finger prints, or that have pin holes may not work properly.
- The following CDs may not work properly.
 - Copy control compact discs (CCCD)
 - Recordable compact discs (CD-R)
 - Rewritable compact discs (CD-RW)
- **Do not use the following CDs as they may cause the CD player to malfunction.**
 - 8 cm (3.1 in) discs with an adaptor
 - CDs that are not round
 - CDs with a paper label

ANTENNA

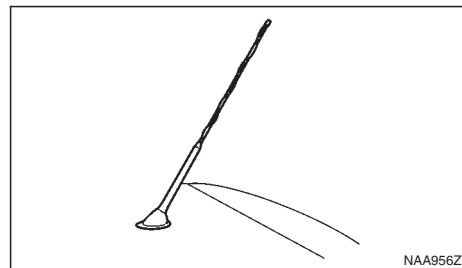

Removing the antenna

To remove the antenna, hold the lower part of the antenna and turn it anticlockwise.

CAUTION

Make sure to remove the antenna before the vehicle enters a garage with a low ceiling or an automatic car wash otherwise the antenna can be damaged.

FM AM RADIO WITH CD PLAYER (where fitted)

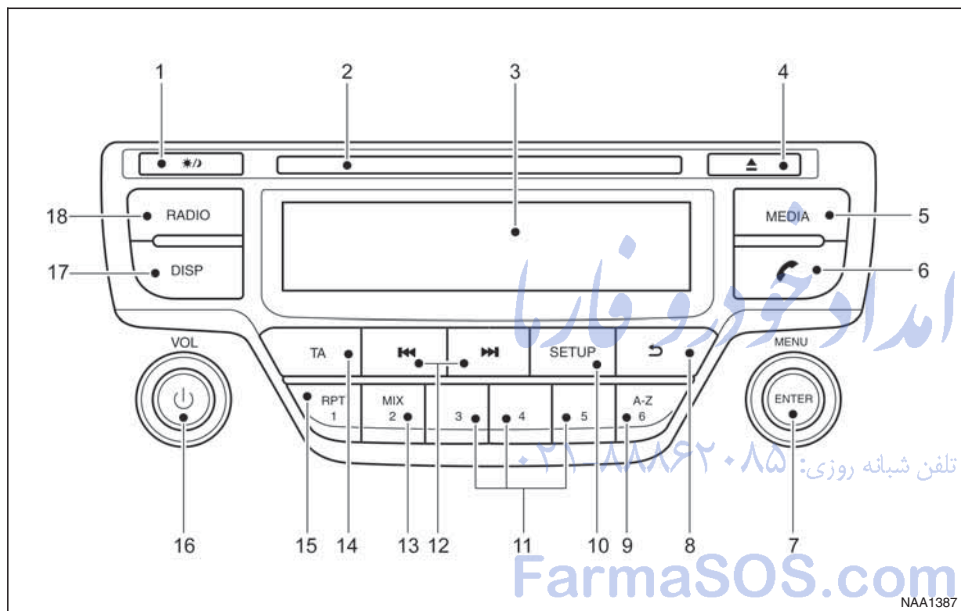

1. ☀/🌙 (Day/Night) button
(Display brightness (Day/Night mode) button)
Turn the MENU button to set the display brightness

The illumination brightness level is linked to the headlight switch. When the headlights are switched "ON" the brightness is dimmed automatically. Press the button to toggle

illumination brightness levels between daytime setting and nighttime setting independent of headlamp status.

2. CD slot
3. Display
4. CD eject button
5. MEDIA button

Switch between the audio sources (CD, USB, AUX, BT Audio)(if connected)

6. Telephone button
7. Radio mode: TUNE dial
Audio unit mode: MENU dial
Confirmation (ENTER) button
8. Back button
9. Radio mode: Preset button
USB/MP3 CD or Phone mode: Quick search button
10. SETUP button
11. Radio mode: Preset buttons
12. Fast Forward (Cue)/Forward Track and Rewind/Previous Track buttons
13. Radio mode: Preset button
CD/iPod/USB/Bluetooth audio mode: MIX button
14. Traffic Announcement (TA) button
15. Radio mode: Preset button
CD/iPod/USB/Bluetooth audio mode: Repeat (RPT) button
16. Power ON-OFF button/Volume control (VOL) knob
17. DISP button
Provides on screen information when available (music tags, RDS, etc.)
18. RADIO button

AUDIO MAIN OPERATION

The audio unit operates when the ignition switch is in Acc or ON position.



Power ON/OFF button

Press the  button to switch on the audio unit. If the audio unit was switched off using the ignition switch, it can also be switched on with the ignition switch. The source that was playing immediately before the unit was switched off will resume playing and the volume will be set to the previous volume level.

The audio unit can be switched off by pressing , or by turning the ignition switch to the "OFF" or LOCK position.

Volume (VOL) level control

Turn the <VOL> dial clockwise or anticlockwise to adjust the volume level.

The audio unit is equipped with a speed control volume function, this means that the audio system automatically adjusts the volume level in relation to vehicle speed. For details, see "[Speed Volume] menu" later in this section.

RADIO OPERATION

When the  (power ON/OFF) button is pressed, the audio unit will switch on with the last received radio station, if the audio unit was previously switched off in radio mode.

The radio is able to receive multiple kinds of audio transmissions:

- FM
- AM

Radio band select buttons

Press the <RADIO> button to change the audio transmission source as follows:

FM1 → FM2 → AM → FM1

When <RADIO> button is pressed, the radio will come on at the last received radio station. If audio is already playing using one of the other input sources (iPod, Bluetooth, CD, USB, AUX-in) pressing the <RADIO> button will switch off the playing source mode and the last received radio station will be selected.

Setting preset stations

Auto populating the [FM List]:

When the <RADIO> button is pressed for more than 1.5 seconds the six stations with the strongest signals are stored in the preset (1 to 6) buttons of the band. During the search, a notification message [Updating FM List] appears in the display and the sound is muted until the operation is complete. Once completed, the radio reverts to the previously selected radio station.



Manual tuning

When adjusting the broadcasting station frequency manually access the [FM List] and turn the <MENU> dial until the desired station is tuned in.

The frequency increases or decreases in steps of 100 kHz on the FM band, and 9 kHz on the AM band.





WARNING

The radio should not be tuned while driving in order for full attention to be given to the driving operation.



SEEK tuning buttons

FM mode:

Pressing the  or  button starts the tuning mode. A short press of the button will increase or decrease the frequency a single step. Pressing the button longer will activate the seek mode. The radio tuner seeks from low to high or high to low frequencies and stops at the next broadcasting station. During seek mode, the audio output is muted. If no broadcasting station can be found within the complete band cycle, it will return to the initial frequency.

Preset station buttons ①②③④⑤⑥

Pressing a preset button for less than 2 seconds will select the stored radio station.

Pressing a preset button for more than 2 seconds while in the [FM list] or radio main screen will cause the station currently being received to be stored against that preset button.

- Twelve stations (if available) can be stored in the FM bands. (Six each for FM1 and FM2)
- Six stations (if available) can be set for the AM band.

If the battery is disconnected, or if the fuse blows, the radio memory will be erased. In that case, reset the desired stations after battery connection or fuse replacement.

Radio Data System (RDS) operation (where fitted)

The RDS is a system through which encoded digital information is transmitted by FM radio stations in addition to the normal FM radio broadcasting. The RDS provides information services such as station name, traffic information, or news.

NOTE

- In some countries or regions, some of these services may not be available.

Alternative Frequency (AF) mode:

The AF mode operates in the FM (radio) mode.

- The AF mode operates in the FM (radio), AUX or CD mode (if FM was previously selected in the radio mode).

- The AF function compares signal strengths and selects the station with the optimum reception conditions for the currently tuned-in station.

RDS functions

Programme Service (PS) function (station name display function):

- FM:
When an RDS station is tuned in with seek or manual tuning, the RDS data is received and the PS name is displayed.

TA Traffic announcement

This function operates in FM (Radio) mode. This function will still operate in the background if any media source is selected (CD, USB or MEDIA mode).

- Pressing the <TA> button selects the TA mode. The TA indicator is displayed while TA mode is on.
- When <TA> is pressed again, The mode will be switched off and the TA indicator will disappear from the display.

Traffic announcement interrupt function:

When a traffic announcement is received, the announcement is tuned in and the display shows a notification message with the radio station name e.g. [TA: Radio 1].

Once the traffic announcement has finished, the unit returns to the source that was active before the traffic announcement started.

If <TA> is pressed during a traffic announcement, the traffic announcement interrupt mode is cancelled. The TA mode returns to the standby mode and the audio unit returns to the previous source.

SETUP BUTTON



To configure [Audio], [Clock], [Radio], and [Language] settings, perform the following procedure:

1. Press the <SETUP> button.
2. Turn the <MENU> dial clockwise or anticlockwise, the display will appear in the following order:

[Audio] ↔ [Clock] ↔ [Radio] ↔ [Language]

After the desired levels have been set, press either the  (Back) button repeatedly, or the <SETUP> button.

Audio adjustments

1. Press the <SETUP> button to enter the setup menu screen then select [Audio].
2. Turn the <MENU> dial clockwise or anticlockwise, the display will appear in the following order:

[Sound] → [AUX in] → [Speed Volume] → [Bass Boost] → [Audio Default]

[Sound] menu:

Submenus in the sound menu:

- [Bass] Use this control to enhance or attenuate bass response sound. Turn the <MENU> dial clockwise or anticlockwise to adjust the bass settings then press <ENTER> to confirm.
- [Treble] Use this control to enhance or attenuate the treble. Turn the <MENU> dial clockwise or anticlockwise to adjust the treble settings then press <ENTER> to confirm.
- [Balance] Use this control to adjust the balance of the volume between the left and right speakers. Turn the <MENU> dial anticlockwise or clockwise to adjust the left/right balance then press <ENTER> to confirm.
- [Fade] Use this control to adjust the balance of the volume between the front and rear speakers. Turn the <MENU> dial anticlockwise or clockwise to adjust the front/rear balance then press <ENTER> to confirm.

[AUX in] menu:

Use this control to adjust the volume output from the auxiliary source.

Turn the <MENU> dial anticlockwise or clockwise to select [Low], [Medium], or [High] mode then press <ENTER> to confirm.

Set the AUX-in volume. Select one of the submenus in the [AUX in] menu:

- [Low]
- [Medium]
- [High]

[Speed Volume] menu:

Set the audio system to automatically adjust the volume level in relation to vehicle speed.

Turn the <MENU> dial anticlockwise or clockwise to adjust the volume, higher (more) bars mean the volume level relatively changes more when the vehicle speed increase or decreases. Press <ENTER> to confirm.

This mode controls the volume output from the speakers automatically in relation to vehicle speed. When [Speed Volume] is displayed, turn the <MENU> dial clockwise or anticlockwise to adjust the volume level.

Adjusting the setting to 0 (zero) turns off the speed volume feature. Increasing the speed volume setting results in the audio volume increasing more rapidly with vehicle speed. Once chosen, press <ENTER> to save the setting.

[Bass Boost] menu:

Switch [Bass boost] [ON] or [OFF]

[Audio default] menu:

The audio unit has a saved preset settings as a factory default. Select [Yes] to change all settings back to the factory preset settings. Select [No] to exit the menu keeping the current settings.

Setting the clock

The clock menu screen set up screen will appear when selecting the [Clock] item from the set up menu.

[Set Time]:

Select [Set Time] then adjust the clock as follows:

1. The hour display will start flashing. Turn the <MENU> dial to adjust the hour.
2. Press the <ENTER> button. The minute display will start flashing.
3. Turn the <MENU> dial to adjust the minute.
4. Press <ENTER> to finish the clock adjustment.

[On/Off]:

Set the clock display between on or off when the audio unit is turned off.

If set in the [ON] position, the clock will be displayed when the audio unit is turned off either by pressing the  button or when the ignition switch is placed in the "OFF" position.

[Format]:

Set the clock display between 24-hour mode and 12-hour clock mode.

[Radio] menu

For activation or deactivation details, see "SETUP button" later in this section.

Language settings

Select the appropriate language and press the <ENTER> button. Upon completion, the screen will automatically adapt the language setting.

- [AUTO]
(Factory preset language connected with the meter language)
- [Chinese]
- [Chinese Simplified]
- [Deutsch]
- [Español]
- [Français]
- [Italiano]
- [Nederlands]
- [Polski]
- [Português]
- [Türkçe]
- [UK English]
- [русский]

COMPACT DISC (CD) OPERATION

The CD player can play a music CD or an encoded MP3/WMA CD and while listening to those CD's music information tags (track and artist information) can be displayed (when CD encoded with text is being used).

Press the <MEDIA> button and the CD (if loaded) will start to play.

When <MEDIA> is pressed and the radio or another source mode is already operating, it will automatically turn off the playing source and the CD play mode will start.

CAUTION

- **Do not force the CD into the slot. This could damage the player.**

- **Do not use 8 cm (3.1 in) discs.** تلفن شبانه روز

CD insert (CD player)

Insert the CD disc into the slot with the label side facing up. The disc will be guided automatically into the slot and will start playing. After loading the disc, track information will be displayed.

NOTE

- **The CD player accepts normal audio CD or CD recorded with MP3/WMA files.**
- **Inserting a CD recorded with MP3/WMA files, the audio unit will automatically detect and [MP3CD] will be indicated.**

- **An error notification message will be displayed when inserting a wrong disc type (e.g. DVD), or the player cannot read the CD disc. Eject the disc and insert another disc.**

MEDIA button

Load a CD disc. After a short loading period the CD starts playing.

If the disc was already loaded:

Press the <MEDIA> button (depending on other connected audio sources if necessary multiple times) to select CD. Playing starts from the track that was being played when the CD play mode was switched off.

Audio main operation



List view:

While the track is being played, either press the <ENTER> button or turn the MENU dial to display the available tracks in a listed view mode. To select a track from the list, or a track to start listening from, turn the <MENU> dial then press <ENTER>.

Press the  button to return to the song.



Fast Forward (Cue), Fast Reverse (Review) buttons:

When the  (Cue) or  (Review) button is pressed continuously, the track will be played at high speed. When the button is released, the track will be played at normal playing speed.



Track up/down buttons:

Pressing the ►► or ◀◀ button once, the track will be skipped forward to the next track or backward to the beginning of the current played track. Press the ►► or ◀◀ button more than once to skip through the tracks.

Folder browsing:

If the recorded media contains folders with music files, pressing the ►► or ◀◀ button will play in sequence the tracks of each folder.

To select a preferred folder:

1. Press the <ENTER> button or turn the <MENU> dial and a list of tracks in the current folder is displayed.
2. Turn the <MENU> dial for the preferred folder.
3. Press <ENTER> to access the folder. Press <ENTER> again to start playing the first track or turn the <MENU> dial, and press <ENTER> to select another track.

If the current selected folder contains sub folders, press <ENTER>, a new screen with a list of sub folders will be displayed. Turn the <MENU> dial for the sub folder then press <ENTER> to select. Select the [Root] folder item when songs are recorded additionally in the root folder.

To return to the previous folder screen, press ↩ .



Repeat button:

Push the RPT ① button and the current track will be played continuously.



button:

Push the MIX ② button and all the tracks in the current folder (MP3 CD/USB) or playlist (iPod) will be played in a random order.

When the entire folder/playlist has been played the system will start playing the next folder/playlist.



button:

While a CD with recorded music information tags (CD-text/ID3-text tags) is being played, the title of the played track is displayed. If the title information is not provided then [Track] is displayed.

When the DISP ⑤ button is pressed repeatedly, further information about the track can be displayed along with the track title as follows:

CD:
Track time → Artist name → Album title → Track time

CD with MP3/WMA:

Track time → Artist name → Album title → Folder name → Track time

The track name is always displayed.

Track details:

A long press on the DISP ⑤ button will turn the display into a detailed overview and after a few seconds it returns to the main display, or press DISP ⑤ briefly.

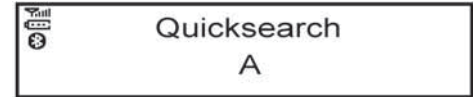

Quick search:

When a MP3 CD with recorded music information tags (ID3-text tags) is being played from list view mode, a quick search can be performed to find a track from the list.

Push the <A-Z> ⑥ button then turn the <MENU> dial for the first alphabetic/numerical letter of the track title then press <ENTER>. When found, a list of the available tracks will be displayed. When there is no match (the display shows [No match]) the next item will be shown. Select, and press <ENTER> to play the preferred track.



CD eject button

CD player:

Press the ▲ (eject) button and the CD will be ejected.

Ejecting CD (with ignition switch in "OFF" or LOCK):

When the ignition switch is in the "OFF" or LOCK position it is possible to eject the currently played CD. However the audio unit will not be activated.

Press the ▲ button and the CD will be ejected.

NOTE

- When the CD is ejected and not removed within 8 seconds, it will automatically retract into the slot to protect it from damage.
- If an error message appears in the display, press ▲ to eject the faulty CD and insert another CD or check if the ejected CD is inserted upside down.

The AUX and USB sockets are located in the centre console underneath the armrest.

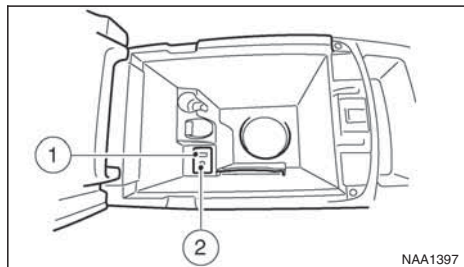

① USB

② AUX

AUX SOCKET

Audio main operation

Open the console lid and connect the AUX jack of a compatible player (e.g. MP3 player) to the socket ②.

Press the <MEDIA> button for the AUX mode. Use the play mode of the device to play the audio.

USB MEMORY OPERATION

(where fitted)

Connecting USB memory

Open the console lid and connect a USB memory stick or another USB device. The display will show the notification message [USB Detected Please Wait...] for a few seconds, while it is reading the data.

If the audio system has been turned off while the USB memory was playing, pressing ⏪ will start the USB device operation.

CAUTION

- Do not force the USB device into the USB port. Inserting the USB device tilted or upside-down into the port may damage the USB device and the port. Make sure that the USB device is connected correctly into the USB port. (Some USB devices come with a ♪ mark as a guide. Make sure that the mark is facing the correct direction before inserting the device.)
- Do not locate objects near the USB device to prevent the objects from leaning on the USB device and the port. Pressure from the objects may damage the USB device and the port.

MEDIA button

To operate the USB device press <MEDIA> once or repeatedly until [USB] is available.

Audio main operation

The following operations are identical to the audio main operation of the Compact Disc (CD) operation. For details, see "Audio main operation" earlier in this section.

- List view
- Quick search
- ⏪, ⏩
- MIX (Random play)
- RPT (Repeat track)
- Folder browsing

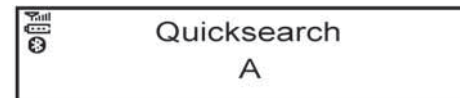

Quick search:

When a USB device with recorded music information tags (ID3-text tags) is being played from list view mode, a quick search can be performed to find a track from the list.

Push the <A-Z> ⑥ button then turn the <MENU> dial for the first alphabetic/numerical letter of the track title then press <ENTER>. When found, a list of the available tracks will be displayed. When there

is no match (the display shows [No match]) the next item will be shown. Select, and press <ENTER> to play the preferred track.

DISP button ⑤

While a track with recorded music information tags (ID3-tags) is being played, the title of the played track is displayed. If the tags are not provided then a notification message is displayed.

When the **DISP** ⑤ button is pressed repeatedly, further information about the track can be displayed along with the track title as follows:

Track time → Artist name → Album title → Track time

Track details:

A long press on the **DISP** ⑤ button will turn the display into a detailed overview and after a few seconds it returns to the main display, or press **DISP** ⑤ briefly.

iPod® PLAYER OPERATION (where fitted)

Connecting iPod®

Open the console lid and connect the iPod cable to the USB connector. The battery of the iPod® will be charged during the connection to the vehicle. The display will show the notification message [iPod <Name> Detected...] for a few seconds, while it is reading the data.

If the audio system has been turned off while the iPod® was playing, pressing  will start the iPod®

operation. During the connection, the iPod® can only be operated with the audio controls.

* iPod® and iPhone® are trademarks of Apple Inc., registered in the U.S. and other countries.

CAUTION

- Do not force the iPod cable into the USB port. Inserting the iPod cable tilted or upside-down into the port may damage the iPod cable and the port. Make sure that the iPod cable is connected correctly into the USB port. (Some iPod cables come with a mark as a guide. Make sure that the mark is facing the correct direction before inserting the iPod cable.)
- Do not locate objects near the iPod cable to prevent the objects from leaning on the iPod cable and the port. Pressure from the objects may damage the iPod cable and the port.

Compatibility:

NOTE

- At the time of publication, this audio system was tested with the latest iPod® players/iPhone® available. Due to the frequent update of consumer devices like MP3 players, NISSAN cannot guarantee that all new iPod® players/iPhone® launched will be compatible with this audio system.
- Some iPod® operations may not be available with this system.

- Make sure that the iPod®/iPhone® is updated with the latest firmware.
- iPod® Shuffle and iPod® mini cannot be used with this system.
- Full functionality of iPhone USB and Bluetooth Audio may not be available to the user if the same device is connected by USB and Bluetooth simultaneously.

MEDIA button

To operate the iPod press <MEDIA> once or repeatedly until [iPod <Name>] is shown.



Audio main operation

Interface:

The interface for iPod® operation shown on the audio system display is similar to the iPod® interface. Use the <MENU> dial and the <ENTER> button to play a track on the iPod®.

The following items can be chosen from the menu list screen.

- [Playlists]
- [Artist]
- [Albums]
- [Tracks]

- [Composers]
- [Genre]
- [Podcasts]

For further information about each item, see the iPod® owner's manual.

The following operations are identical to the audio main operation of the Compact Disc (CD) operation. For details, see "Audio main operation" earlier in this section.

- List view
- 
- MIX (Random play)
- RPT (Repeat track)
- Folder browsing

DISP button ⑤

While a track with recorded music information tags (ID3-tags) is being played, the title of the played track is displayed. If the tags are not provided then a notification message is displayed.

When the DISP⑤ button is pressed repeatedly, further information about the track can be displayed along with the track title as follows:

Track time → Artist name → Album title → Track time

Track details:

A long press on the DISP⑤ button, the screen displays the song title, artist name, and album title. After a few seconds it returns to the main display or press DISP⑤ briefly.

BLUETOOTH® OPERATION

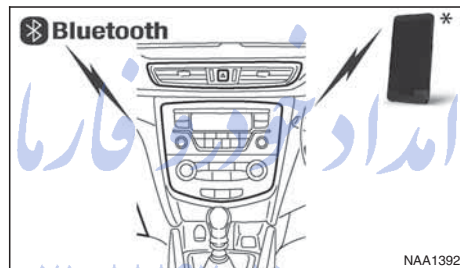

*: a device with bluetooth capabilities

Regulatory information



Bluetooth® is a trademark owned by Bluetooth SIG, Inc.

CE statement

Hereby Yanfeng Visteon Automotive Electronics Co., Ltd. declares that this system is in compliance with the essential requirements and other relevant provisions of Directive 1999/5/EC.



NOTE

The audio system only supports Bluetooth® devices with AVRCP (Audio Video Remote Control Profile) version 1.4 or earlier.

BLUETOOTH® settings

To pair a device, make sure the Bluetooth is switched on and use the [Scan device] key or the [Pair device] key. For details, see "[Scan devices]" later in this section.

Up to 5 different Bluetooth devices can be connected. However, only one device can be used at a time. If 5 different Bluetooth registered devices are registered, a new device can only replace one of the 5 existing paired devices. Use [Del. device] key to delete one of the existing paired devices. For details, see "[Del. device]" later in this section.

When successfully paired a notification message will be displayed, then the audio system display will return to the current audio source display. During connection the following status icons will be displayed (top left of the display): Signal strength (📶), Battery status* (🔋) and Bluetooth "ON" (📶).

*: If the low battery message comes on, the Bluetooth® device must be recharged soon.

The pairing procedure and operation may vary according to device type and compatibility. See the Bluetooth® owner's manual for further details.

NOTE

- For device details, see your audio/mobile phone Owner's Manual.
- For assistance with the Bluetooth® audio/mobile phone integration, please visit your local NISSAN dealer.

To set up the Bluetooth system with a device the following items are available:



- [Scan devices]
Bluetooth devices can be paired with the system. A maximum of 5 Bluetooth devices can be registered.
- [Pair device]
Bluetooth devices can be paired with the system. A maximum of 5 Bluetooth devices can be registered.
- [Sel. device]
Paired Bluetooth devices are listed and can be selected for connection.

- [Del. device]
A registered Bluetooth device can be deleted.
- [Bluetooth]

If this setting is turned off, the connection between the Bluetooth devices and the in-vehicle Bluetooth module will be cancelled.

[Scan devices]:

- 1) Press the button. Select [Scan device]
The audio unit searches bluetooth devices and shows all visible devices.
Make sure your Bluetooth device is visible at this time.
- 2) Select the device to be paired.
Use the <MENU> dial and press to select.
- 3) The pairing procedure may depend on the device to be connected:

- 1) Device without PIN code:

The Bluetooth connection will be automatically connected without any further input.

- 2) Device with PIN code:
Two different ways of pairing are possible depending on the device:

- Type A:
The message [To pair] [Enter Pin] 0000 will be displayed.
Confirm the PIN code on the device.
The Bluetooth connection will be made.

- Type B:
The message [Pairing request] [Confirm password] together with a 6 digit code will be displayed. The unique and identical code should be displayed on the device. If the code is identical confirm on the device.
The Bluetooth connection will be made.

[Pair device]:

- Turn the audio unit Bluetooth® on. See [Bluetooth] description.
- Use the audio unit to pair:
Press the button. Select the [Pair Device] key.
The pairing procedure depends on the Bluetooth® device to be connected:
 - 1) Device without PIN code:
The Bluetooth® connection will be automatically connected without any further input.
 - 2) Device with PIN code:
Two different ways of pairing are possible depending on the device, for the correct procedure details, see "[Scan devices]" earlier in this section.
- Use the Bluetooth® audio/mobile phone device to pair:
 - 1) Follow the instructions in the owner's manual for the Bluetooth® enabled device to search for the audio unit.
If the search mode finds the audio unit it will be shown on the device display.

- 2) Select the audio unit shown as [My Car].
- 3) Follow the instructions in the owner's manual for the Bluetooth® enabled device to establish a connection with the audio unit.
- 4) Enter the PIN code shown on the relevant device with the device's own keypad, and press the confirmation key on the device itself.
Refer to the relevant Bluetooth® device owner's manual for further details.

[Sel. device]:

The paired device list shows which Bluetooth® audio or mobile phone devices have been paired or registered with the Bluetooth® audio system. If the list contains devices then select the appropriate device to connect to the Bluetooth® audio system.

The following symbols (where fitted) indicate the capability of the registered device:

- 📶 : Mobile phone integration
- 🎵 : Audio streaming (A2DP – Advanced Audio Distribution Profile)

[Del. device]:

A registered device can be removed from the Bluetooth audio system. Select a registered device then press <ENTER> to confirm to deletion.

[Bluetooth]:

If Bluetooth® has been switched off a notification message [ON/OFF] appears when you select [Bluetooth] from the phone menu (press 📶). To switch

the Bluetooth® signal on, press <ENTER> and a follow up screen will appear. Then select [ON] and press <ENTER> to display the Bluetooth® settings menu screen.

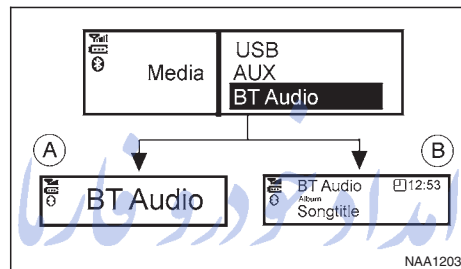

Bluetooth® audio streaming main operation

Turn the ignition switch to the Acc or ON position. If the audio system was turned off while the Bluetooth® audio was playing, pressing the <📶> button will start the Bluetooth® audio streaming.

MEDIA button:

To operate the Bluetooth® audio streaming use the following method:

- Press <MEDIA> repeatedly until [BT Audio] is shown.

The type of display, (A) or (B), shown on the audio system can vary depending on the Bluetooth® version of the device.



Fast Forward (Cue), Fast Reverse (Review) buttons:

When the ►► (Cue) or ◀◀ (Review) button is pressed continuously, the track will be played at high speed. When the button is released, the track will be played at normal playing speed.



Track up/down buttons:

Pressing the ►► or ◀◀ button once, the track will be skipped forward to the next track or backward to the beginning of the current played track. Press the ►► or ◀◀ button more than once to skip through the tracks.

DISP button

If the song contains music information tags (ID3-tags), the title of the played song will be displayed. If tags are not provided then the display will not show any messages.

When the DISP button is pressed repeatedly further information about the song can be displayed along with the song title.

A long press on DISP will turn the display into a detailed overview which after a few seconds returns to the main display; or press DISP briefly.

Bluetooth® mobile phone feature

This system offers a hands-free facility for your mobile telephone with Bluetooth® to enhance driving safety, and comfort.

For details, see "Mobile phone integration for FM AM radio with CD player (where fitted)" later in this section.

امداد خودرو فارما

تلفن شبانه روزی: ۰۲۱-۸۸۸۶۲۰۸۵

FarmaSOS.com

Specification chart

Supported media		CD-R, CD-ROM, CD-RW, USB 2.0 MSC	
CD Size		12 cm diameter. up to 1.9 mm thickness	
Supported file systems for CD		ISO9660 LEVEL1, ISO9660 LEVEL2, Romeo, Joliet * ISO9660 Level 3 (packet writing) is not supported. * Files saved using the Live File System Component (on a Windows Vista-based computer) are not supported.	
Supported file systems for USB		FAT-16, FAT-32	
Supported versions *1	MP3	Version	MPEG1, Layer 3
		Sampling frequency	32 KHz - 44.1 KHz - 48 kHz
		Bit rate	32, 40, 48, 56, 64, 80, 96, 112, 128, 144, 160, 192, 224, 256, 288, 320, Kbps, VBR *4
	WMA *3	Version	WMA7, WMA8, WMA9
		Sampling frequency	16 KHz, 22.05 KHz, 32 KHz, 44.1KHz, 48 kHz
		Bit rate	48, 64, 80, 96, 128, 160, 192, 256, 320 Kbps, VBR *4
	AAC	Version	MPEG-4, AAC
		Sampling frequency	8, 11.025, 16, 22.05, 32, 44.1, 48 kHz
		Bit rate	32, 48, 64, 80, 96, 128, 160, 192 Kbps, VBR *4
Tag information (Song title and Artist and Album name)	CD	CDDA	
	MP3	ID3 tag ver. 1.0, 1.1, 2.2, 2.4	
	WMA	WMA tag	
	AAC	AAC tag	
Tracks/Files support		CDDA — 99 tracks MP3/WMA/AAC in CD — 999 files USB — 30000 files	

Folders support		100 folders in CD 2500 folders in USB Depth — Till 8, Deeper folders shall be under 8, subject to the maximum.
Playlists support in USB		M3U, WPL, PLS — 1000 playlists.
Text character support	Adjustable character length, depending upon content of media.	File Name: Min 11 Characters (Max 30 Characters) ID3 TAG : Min 24 Characters. (Max 60 Characters) *5
Displayable character codes *2	Unicode, ISO8859-15(French), ISO8859-5(Russian Cyrillic), GB18030-2000(Chinese), BIG-5(Taiwanese), KSX1001-2002(Korean)	01:ASCII, 02: ISO-8859-1, ISO8859-15(French), ISO8859-5(Russian Cyrillic), 03: UNICODE(UTF-16 BOM Big Endian), 04: UNICODE (UTF-16 Ncn-BOM Big Endian), 05: UNICODE(UTF-8), 06:UNICODE(Non-UTF-16 BOM Little Endian), 07: SHIFT-JIS, GB18030-2000(Chinese), BIG-5(Taiwanese), KSX1001-2002(Korean)
Browsing		File/Folder browsing for CD/MP3, USB

*1 Files created with a combination of 48 kHz sampling frequency and 64 Kbps bit rate cannot be played.

*2 Available codes depend on what kind of media, versions and information are going to be displayed.

*3 Protected WMA files (DRM) cannot be played.

*4 When VBR files are played, the playback time may not be displayed correctly. WMA7 and WMA8 are not applied to VBR.

*5 Support 128 Bytes but it depends on display width and character type.

FarmaSOS.com

NISSANCONNECT (where fitted)

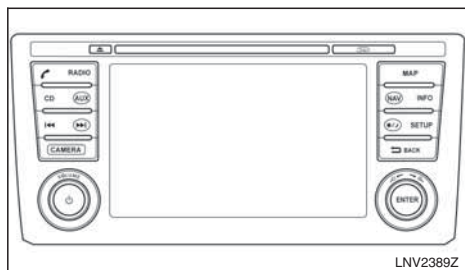

For details, see the separately provided NissanConnect Owner's Manual.

STEERING WHEEL SWITCH FOR AUDIO CONTROL (where fitted)

MAIN OPERATION

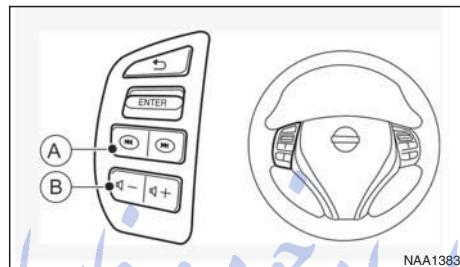

The audio unit can be operated by using the controls on the steering wheel.

(A) Seek up/Seek down buttons

(B) Volume control buttons

To use the steering wheel audio switch, push the power "ON" button of the audio unit with the ignition switch in either the Acc or ON position.

▶▶ or ◀◀ Seek up/Seek down button

– Preset station change (radio mode)

Push the ▶▶ or ◀◀ button to select one of the preset radio stations.

– Seek tuning (radio mode)

Push and hold the ▶▶ or ◀◀ button to start the tuning mode. The radio tuner seeks from low to high or high to low frequencies and stops at the next broadcasting station.

– Track up/down (in CD/USB/iPod/BT Audio modes)

Push the ▶▶ or ◀◀ button to select the next track or to return to the beginning of the present track. Push several times to skip forward or skip back through the tracks.

🔊 Volume control buttons

Push the 🔊 – or 🔊 + button to adjust the volume level.

MOBILE PHONE INTEGRATION FOR FM AM RADIO WITH CD PLAYER (where fitted)

Not for models with NissanConnect system, see the separately provided Owner's Manual.

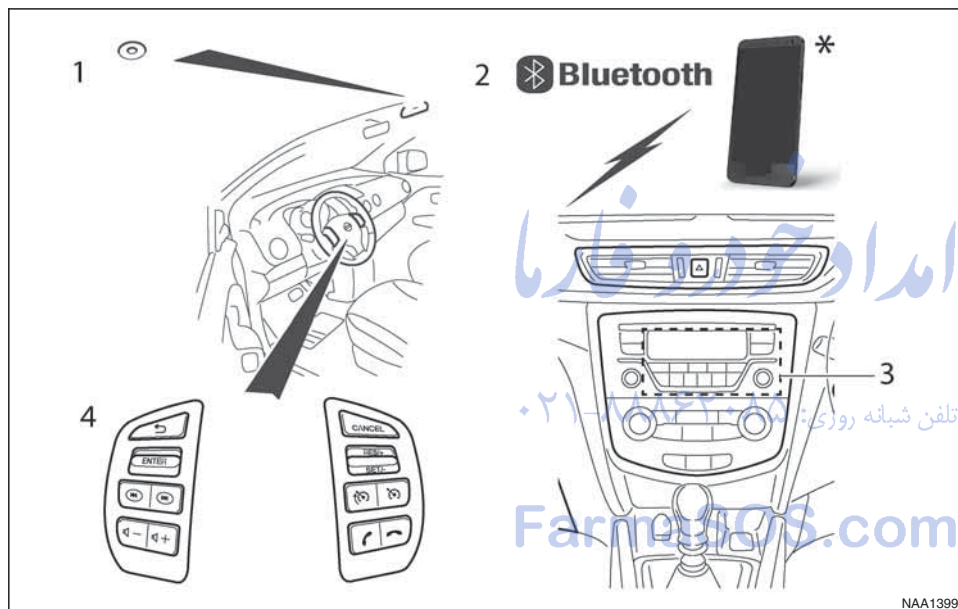

- 1 Microphone location (Located in roof console)
- 2 Supported mobile phone with bluetooth capabilities
- 3 Audio unit with switches for phone control
- 4 Steering wheel switches for phone control

BLUETOOTH® MOBILE PHONE FEATURE

WARNING

Whilst driving, using the mobile phone is extremely dangerous because it significantly impairs your concentration and diminishes your reaction capabilities to sudden changes on the road, and it may lead to a fatal accident. This applies to all phone call situations such as when receiving an incoming call, during a phone conversation, when calling through the phone book search, etc.

CAUTION

Certain country jurisdictions prohibit the use of the mobile phone in the car without hands-free support.

This chapter provides information about the NISSAN hands-free phone system using a Bluetooth® connection.

Bluetooth® is a wireless radio communication standard. This system offers a hands-free facility for your mobile telephone to enhance driving comfort.

In order to use your mobile phone with the Bluetooth® of the audio system, the mobile phone must first be setup. For details, see “BLUETOOTH® settings” later in this section. Once it has been setup, the hands-free mode is automatically activated on the registered mobile phone (via Bluetooth®) when it comes into range.

A notification message appears on the audio display when the phone is connected, when an incoming call is being received, as well as when a call is initiated.

When a call is active, the audio system, microphone (located in the ceiling in front of the rear view mirror), and steering wheel switches enable hands-free communication.

If the audio system is in use at the time, the radio, CD, iPod, USB audio, Bluetooth audio or AUX source mode will be muted and will stay muted until the active call has ended.

The Bluetooth® system may not be able to connect with your mobile phone for the following reasons:

- The mobile phone is too far away from the vehicle.
- The Bluetooth® mode on your mobile phone has not been activated.
- Your mobile phone has not been paired with the Bluetooth® system of the audio unit.
- The mobile phone does not support Bluetooth® technology (BT Core v2.0).

NOTE

- For models with NissanConnect (Audio with Navigation system) see the separately provided Owner’s Manual.
- For details, see your mobile phone’s Owner’s Manual.
- For assistance with your mobile phone integration, please visit your local NISSAN dealer.

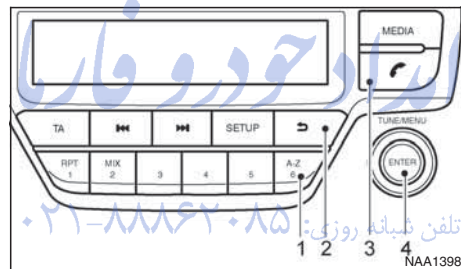

- ① Phone book quick search button A-Z
- ② (Back) button
- ③ Phone button
- ④ <MENU> or <ENTER> button (rotate and push to select)

BLUETOOTH® settings

Enter the phone setup menu via the (phone) button, select the [Bluetooth] key, and then check if the bluetooth is set to on (default setting is on, push the <ENTER> button if not).

To setup the Bluetooth system to pair (connect or register) your preferred mobile phone, follow the following procedure.

To pair a device, use the [Scan device] key or the [Pair device] key.

Up to 5 different Bluetooth devices can be connected. However, only one device can be used at a time. If 5 different Bluetooth registered devices are registered, a new device can only replace one of the 5 existing paired devices. Use [Del. device] key to delete one of the existing paired devices. For details, see “BLUETOOTH® settings” later in this section.

When successfully paired a notification message will be displayed, then the audio system display will return to the current audio source display. During connection the following status icons will be displayed (top left of the display): Signal strength (), Battery status* () and Bluetooth “ON” ().

*: If the low battery message comes on, the Bluetooth® device must be recharged soon.

The pairing procedure and operation may vary according to device type and compatibility. See the Bluetooth® owner’s manual for further details.

NOTE

- For device details, see your audio/mobile phone Owner’s Manual.
- For assistance with the Bluetooth® audio/mobile phone integration, please visit your local NISSAN dealer.

- A maximum of 5 Bluetooth devices can be paired with the system.

To set up the Bluetooth system with a device the following items are available:



- [Scan device]
Shows all available visible Bluetooth devices and initializes Bluetooth connection from the audio unit.
- [Pair device]
Initializes Bluetooth connection from the mobile device.
- [Sel. device]
Paired Bluetooth devices are listed and can be selected for connection.
- [Del. device]
A registered Bluetooth device can be deleted.
- [Bluetooth]
If this setting is turned off, the connection between the Bluetooth devices and the in-vehicle Bluetooth module will be cancelled.

[Scan devices]:

- 1) Press the  button. Select [Scan device]
The audio unit searches bluetooth devices and shows all visible devices.

Pressing the  button cancels the search.

- 2) Select the device to be paired.
Use the <MENU> dial and press to select.
- 3) The pairing procedure depends on the device to be connected:

- 1) Device without PIN code:
The Bluetooth connection will be automatically connected without any further input.

- 2) Device with PIN code:
Two different ways of pairing are possible depending on the device:

- Type A:
The message [To pair] [Enter Pin] 0000 and a count down timer will be displayed. Confirm the PIN code on the device. The Bluetooth connection will be made.

If the count down timer reaches 0 the attempt to pair the devices will be cancelled.

- Type B:
The message [Pairing request] [Confirm password] together with a 6 digit code will be displayed. The unique and identical code should be displayed on the device. If the code is identical confirm on the device.
The Bluetooth connection will be made.



[Pair device]:

- Turn the audio unit Bluetooth on. See [Bluetooth] description.
- Use the audio unit to pair:
Press the  button. Select the [Pair device] key. The Audio unit will wait for a connection request from the mobile device. The pairing procedure depends on the Bluetooth device:
 - 1) Device without PIN code:
The Bluetooth connection will be automatically connected without any further input.
 - 2) Device with PIN code:
Two different ways of pairing are possible depending on the device, see under [Scan device] for a description.
- Use the Bluetooth® audio/mobile phone device to pair:
 - 1) Switch **ON** the Bluetooth® devices search mode on the mobile device.
If the search mode finds the audio unit it will be shown on the device display.
 - 2) Select the audio unit shown as [My Car].
 - 3) Enter the number code shown on the relevant device with the device's own keypad, and press the confirmation key on the device itself.
Refer to the relevant Bluetooth® device owner's manual for further details.

[Sel. device]:

The paired device list shows which Bluetooth® audio or mobile phone devices have been paired or registered with the Bluetooth® audio system. If the list contains devices then select the appropriate device to connect to the Bluetooth® audio system.

The following symbols (where fitted) indicate the capability of the registered device:

-  : Mobile phone integration
-  : Audio streaming (A2DP – Advanced Audio Distribution Profile)



[Del. device]:

A registered device can be removed from the Bluetooth audio system. Select a registered device then press <ENTER> to confirm the deletion.

[Bluetooth]:

If Bluetooth® has been switched off a notification message [ON/OFF] appears when you select [Bluetooth] from the phone menu (press ). To switch the Bluetooth® signal on, press <ENTER> and a follow up screen will appear. Then select [ON] and press <ENTER> to display the Bluetooth® settings menu screen.

HANDS-FREE TELEPHONE CONTROL

The hands-free mode can be operated using the telephone  button on the audio system, or the  and (where fitted) on the steering wheel.







Receiving a call

When receiving an incoming call, the display will show the caller's phone number (or a notification message that the caller's phone number cannot be shown) and three operation icons.

1. Answering and during a call:

Answer the call by pressing <ENTER> (the  is highlighted).

By pressing <ENTER>, you can select the following options:

- Ending the call by selecting  and press <ENTER>.
 - Put the call on hold by selecting  and press <ENTER>.
 - []
- Use this item (the transfer handset command) to transfer the call from the audio system to your mobile phone.
To transfer the call back to hands-free via the audio system select [].

• [#123]

Use this item to enter numbers during a call. For example, if directed by an automated phone system to dial an extension number the system will send the tone associated with the selected number.

2. Put a call on hold:

Rotate the <MENU> dial until  is highlighted, press <ENTER>. The call is on hold. Pressing <ENTER> accepts the call, rotate the <MENU> dial clockwise and press <ENTER> to reject.

3. Rejecting a call:

Rotate the <MENU> dial until  is highlighted, press <ENTER>. The call is rejected.



Initiating a call

A call can be initiated using one of the following methods:

- Making a call from the phone book
- Manually dialing a phone number
- Redialing

– Using call history (Call List menu)

- Dialed
- Received
- Missed



Making a call from the phone book:

Once the Bluetooth® connection has been made, between the registered mobile phone and the audio system, phone book data will be transferred automatically to the audio system. The transfer may take a while before completion.

NOTE

Phone book data will be erased when:

- Switching to another registered mobile phone.
 - Mobile phone is disconnected.
 - The registered mobile phone is deleted from the audio system.
1. Press  >.
 2. Turn the <MENU> dial and scroll down to [Phone Book] then press <ENTER>.
 3. Scroll down through the list, select the appropriate contact name (highlighted), and press <ENTER>.
 4. A following screen will show the number to be dialed. If correct, press <ENTER> again to dial the number.

If the contact has more numbers assigned for  (home),  (mobile), or  (office), scroll, and select the appropriate number to dial.

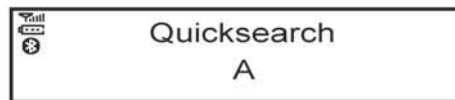

Alternatively, the quick search mode can be used as follows:

1. While in the phonebook screen press <A-Z/>  >.
2. Turn the <MENU> dial for the first alphabetic or numerical letter of the contact name. Once highlighted, press <ENTER> to select the letter.
3. The display will show the corresponding contact name(s). Where necessary, use the <MENU> dial again to scroll further for the appropriate contact name to call.
4. A following screen will show the number to be dialed. If correct, press <ENTER> again to dial the number.





Manually dialing a phone number:



Park the vehicle in a safe location, and apply the parking brake before making a call.

To dial a phone number manually use the audio system display (virtual keyboard pad) as follows:

1. Press  , and turn the <MENU> dial to highlight [Call Number].
2. Press <ENTER> to select [Call Number].
3. Turn the <MENU> dial to scroll along, and select each number of the phone number. Once highlighted, press <ENTER> after each number selection.

To delete the last number entered scroll to the [<-] (Backspace) symbol, and once highlighted press <ENTER>. The last number will be deleted. Pressing <ENTER> repeatedly will delete each subsequent number.

4. After entering the last number, scroll to the  symbol, and press <ENTER> to dial the number.

Redial:

To redial or call the last number dialed, press  for more than 2 seconds.



Using call history (Call List menu):

A number from the dialed, received, or missed call lists can also be used to make a call.

- [Dialed]



Use the dialed call mode to make a call which is based on the list of outgoing (dialed) calls.

- [Received]

Use the received call mode to make a call which is based on the list of received calls.

- [Missed]

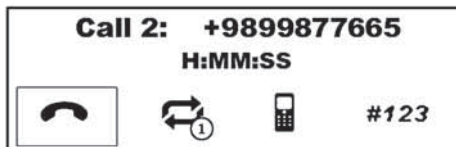

Use the missed call mode to make a call which is based on the list of missed calls.

1. Press , and select [Call List].
2. Turn the <MENU> dial to scroll to an item, and press <ENTER> to select it.
3. Scroll to the preferred phone number then press <ENTER>, or press  to dial the number.



Second incoming call

Whenever there is a second incoming call is shown in the display. By selecting the  icon the call is accepted and the current call is put on hold.

Selecting  by rotating <MENU> and pressing <ENTER> rejects the second incoming call. When this is done during the conversation it ends the call. Selecting the  key using the <MENU> dial and pressing <ENTER> switches between the phone conversations.

(For the other selections, see Making a call from the phone book earlier)



General settings

From the phone menu select [Settings]

Volume settings and manually downloading the phonebook can be done using this menu.

Menu operation:

Press <ENTER> to select, rotate the <MENU> dial to increase or decrease the volume.

Press <ENTER> to confirm.

Menu items:

- [Volume]
 - [Ring]
 - Set the phone ringing volume
 - [Call]
 - Set the volume of the conversation during a call.
- [Ringtone]
 - [Car]
 - Choose the in car ringtone.
 - [Phone]
 - Choose the phone ringtone.
- [PB download]
 - Download the phonebook of the mobile device to the audio unit manually.

STEERING WHEEL SWITCHES (where fitted)

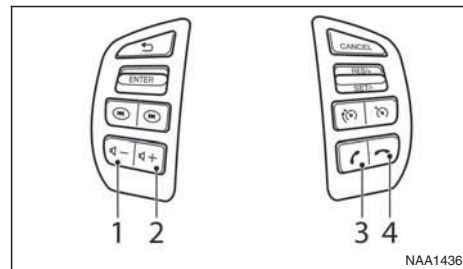

- ① Volume down button
- ② Volume up button

CAR PHONE OR CB RADIO

- ③ Phone button
- ④ Phone end/reject button

The hands-free mode can be operated using the steering wheel switches.

Volume down button

Press the volume down button to decrease the volume of the speakers.

Volume up button



Press the volume up button to increase the volume of the speakers.

Phone button

The phone  button allows you to:

- Accept an incoming call by pressing once.
- Redial the last outgoing call by pressing the for more than 2 seconds.

Phone END button

- Reject an incoming call by pressing  during an incoming call.
- End an active call by pressing  once.

When installing large capacity wireless equipment or a car phone in your NISSAN, be sure to observe the following as it may adversely affect the Engine control system and other electronic parts depending on its installation location.

CAUTION

- **Keep the antenna as far as possible away from the Electric Control Module.**
- **Also keep the antenna wire more than 20 cm (8 inches) away from the Electro Injection harness. Do not route the antenna wire next to any harness.**
- **Adjust the antenna standing-wave ratio as recommended by the manufacturer.**
- **Connect the ground wire from the radio chassis to the body.**

NOTE

For further information, visit the NISSAN web site: www.nissan-europe.com. Select your country from the list and go to the "SERVICES" menu. If not available on the web site, contact a NISSAN dealer or qualified workshop.

5 Starting and driving

Running-in schedule	5-2	Precautions on push-button ignition switch operation	5-12
Before starting the engine	5-2	Intelligent Key system	5-12
Precautions when starting and driving	5-3	Ignition switch positions	5-13
Exhaust gas (Carbon Monoxide)	5-3	Emergency engine shut off	5-14
Tyre Pressure Monitoring System (TPMS)	5-4	Steering lock	5-14
Meter information	5-7	Intelligent Key battery discharge	5-14
Activation	5-7	Starting engine	5-15
TPMS sensor ID and position recognition	5-7	Models with Intelligent Key system	5-15
Adjusting TPMS target pressure	5-8	Models without Intelligent Key system	5-16
Tyre pressure units	5-8	Driving the vehicle	5-17
[Check cold tyre] message	5-8	Driving with manual transmission	5-17
TPMS temperature calibration	5-8	Driving with XTRONIC Transmission (CVT)	5-18
On-pavement and off-road driving precautions	5-9	Stop/Start System (where fitted)	5-22
Three-way catalyst (Petrol engine models)	5-9	Normal operation	5-22
To help prevent damage	5-9	Precautions	5-24
Turbocharger system (Diesel engine models)	5-10	Stop/Start System OFF switch	5-25
Care when driving	5-10	Environmental savings	5-25
Engine cold start period	5-10	Four-wheel Drive (4WD) (where fitted)	5-26
Loading luggage	5-10	4WD mode operations	5-27
Driving on wet roads	5-10	4WD shift tips	5-27
Driving under winter conditions	5-10	4WD Mode indicator lights	5-28
Ignition switch (where fitted)	5-11	Driving four-wheel drive (4WD) safely	5-28
Manual transmission	5-11	Blind Spot Warning (BSW) system (where fitted)	5-30
XTRONIC transmission (CVT)	5-11	BSW system operation	5-30
Steering lock	5-11	BSW driving situations	5-32
Key positions	5-11	BSW temporary disabled status	5-32
NISSAN Anti-Theft System (NATS) (where fitted)	5-12	BSW automatic deactivation	5-33
Push-button ignition switch (where fitted)	5-12	BSW malfunction	5-33
		BSW camera unit maintenance	5-33

Lane Departure Warning (LDW) system (where fitted)	5-33	Installation of coupling device (except for Australia)	5-56
LDW system operation	5-34	Vehicle security.....	5-57
LDW temporary disabled status	5-35	Electric power steering system	5-57
LDW automatic deactivation	5-35	Brake system.....	5-58
LDW malfunction.....	5-35	Brake precautions	5-58
Multi-sensing camera unit maintenance	5-35	Anti-lock Braking System (ABS).....	5-59
Cruise control (where fitted)	5-36	Using system.....	5-59
Precautions on cruise control.....	5-36	Self-test feature	5-59
Cruise control system operations	5-37	Normal operation	5-60
Speed limiter (where fitted)	5-38	Electronic Stability Programme (ESP) system (where fitted)	5-60
Speed limiter operations	5-39	Electronic Stability Programme (ESP) OFF switch.....	5-61
Forward emergency braking system (where fitted) ...	5-40	Chassis control.....	5-62
System operation.....	5-41	Active trace control	5-62
Parking.....	5-43	Active engine brake (for XTRONIC (CVT) models only)	5-63
Ultrasonic Parking Sensors (where fitted).....	5-45	Active ride control.....	5-64
Operation	5-45	Hill Start Assist (HSA) system.....	5-64
Intelligent Parking Assist (IPA) (where fitted)	5-46	ECO mode system (where fitted)	5-65
Deactivation of the IPA system.....	5-47	Cold weather driving.....	5-66
Parking procedure using the IPA system.....	5-48	Battery	5-66
Operating tips.....	5-52	Engine coolant.....	5-66
Trailer towing.....	5-54	Tyre equipment.....	5-66
Operating precautions	5-54	Special winter equipment.....	5-67
Maximum load limits (for Australia)	5-55	Corrosion protection.....	5-67
Tyre pressure	5-55		
Safety chains.....	5-55		
Trailer brakes.....	5-55		
Trailer detection (where fitted)	5-56		

RUNNING-IN SCHEDULE

During the first 1,600 km (1,000 miles), follow these recommendations for the future reliability and economy of your new vehicle. Failure to follow the recommendations may result in shortened engine life and reduced engine performance.

- Avoid driving for long periods at a constant speed, either fast or slow.
- Do not accelerate at full throttle in any gear.
- Avoid quick starts.
- Avoid hard braking as much as possible.
- Do not tow a trailer during the first 800 km (500 miles).

NOTE

Models with K9K diesel engine will achieve top performance only after approximately 5,000 km (3,000 miles).

BEFORE STARTING THE ENGINE



WARNING

The driving characteristics of your vehicle can be changed remarkably by any additional load and its distribution as well as by adding optional equipment (trailer couplings, roof racks, etc.). Your driving style and speed have to be adjusted accordingly. Especially when carrying heavy loads, your speed must be reduced adequately.

- Make sure the area around the vehicle is free of obstacles.
- Check fluid levels such as engine oil, coolant, brake and clutch fluid, and window washer fluid as frequently as possible, at least whenever you refuel.
- Visually inspect tyres for their appearance and condition. Also check the tyre pressure for proper inflation.
- Maintenance items in the "8. Maintenance and do-it-yourself" section should be checked periodically.
- Check that all windows and light lenses are clean.
- Check that all doors are closed.
- Position the seat and adjust the head restraints.
- Adjust the inside and outside mirrors.
- Fasten your seat belt and ask all passengers to do likewise.

- Check the operation of the warning/indicator lights when the ignition switch is turned to the ON position.
- Do not place hard or heavy objects on the dashboard or rear parcel shelf in order to prevent injury in the event of a sudden stop.

PRECAUTIONS WHEN STARTING AND DRIVING



WARNING

- Do not leave children or adults who would normally require the support of others alone in your vehicle. Pets should also not be left alone. They could accidentally injure themselves or others through inadvertent operation of the vehicle. Also, on hot, sunny days, temperatures in a closed vehicle could quickly become high enough to cause severe or possibly fatal injuries to people or animals.
- To prevent luggage or packages from sliding forward during braking, do not stack anything in the cargo area higher than the seatbacks.
- Secure all cargo with ropes or straps to prevent it from sliding or shifting.
- Failure to follow proper seating instructions see “Seats” in the “1. Safety — Seats, Seat belts and Supplemental Restraint System” section, could result in serious personal injury in an accident or sudden stop.

EXHAUST GAS (Carbon Monoxide)



WARNING

- Do not breathe exhaust gases; they contain colourless and odourless carbon monoxide. Carbon monoxide is a dangerous gas and can cause unconsciousness or death.

- If you suspect that exhaust fumes are entering the vehicle, drive with all windows fully open and have the vehicle inspected immediately.
- Do not run the engine in closed spaces, such as a garage, for any longer than is absolutely necessary.
- Do not park the vehicle with the engine running for any extended length of time.
- Keep the back door closed while driving, otherwise exhaust gases could be drawn into the passenger compartment. If you must drive in this way for some reason, take the following steps:
 - 1) Open all the windows.
 - 2) Set the air recirculation mode (OFF) to the “OFF” position.
 - 3) Set the fan speed control to the maximum position to circulate the air.
- If electrical wiring or other cable connections must pass to a trailer through the seal of the body, follow the manufacturer’s recommendations to prevent carbon monoxide entry into the vehicle.
- When a vehicle has been stopped in an open area with its engine running for any significant length of time, turn the fan on to force outside air into the vehicle.
- The exhaust system and body should be inspected by a NISSAN dealer or qualified workshop whenever:
 - the vehicle is raised for service.
 - you suspect that exhaust fumes are entering into the passenger compartment.
 - you notice a change in the sound of the exhaust system.
 - you have had an accident involving damage to the exhaust system, underbody, or rear of the vehicle.

TYRE PRESSURE MONITORING SYSTEM (TPMS)

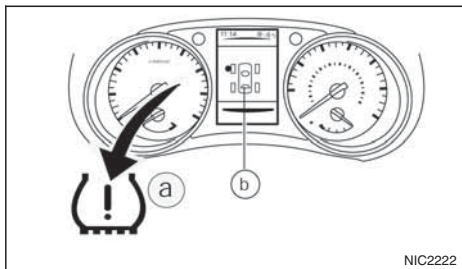

- (a) TPMS indicator light
- (b) TPMS tyre location indicator

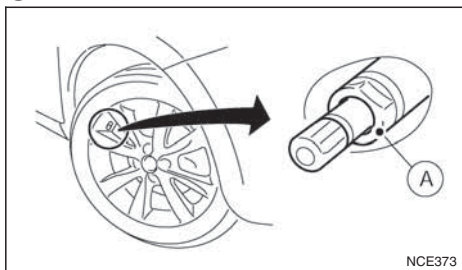

- (A) Tyre valve with sensor

The tyre pressure monitoring system monitors the tyre pressure of the four wheels while the vehicle is in motion. Following a loss in pressure, the system will warn the driver using a visual warning. Each

TPMS sensor (A) has a registered wheel location and sends pressure and temperature data via radio to a receiver inside the vehicle.

Each tyre, including the spare (where fitted), should be checked monthly when cold and inflated to the inflation pressure recommended by the vehicle manufacturer on the vehicle placard or tyre inflation pressure label. (If your vehicle has tyres of a different size than the size indicated on the vehicle placard or tyre inflation pressure label, you should determine the proper tyre inflation pressure for those tyres.)

The Tyre Pressure Monitoring System (TPMS) controls the TPMS indicator light (a), which will illuminate when one or more tyres are significantly under-inflated. A warning and tyre location indicator (b) will also appear in the vehicle information display to identify the tyre or tyres with low pressure. تلفن شه

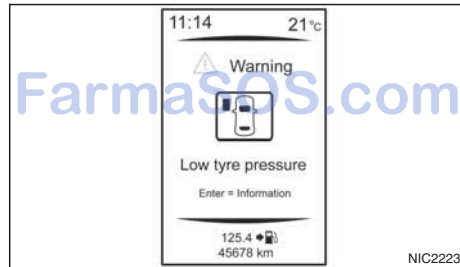

If you now press the <ENTER> switch on the steering wheel, a further screen is displayed to tell you the tyre pressure of all four tyres.

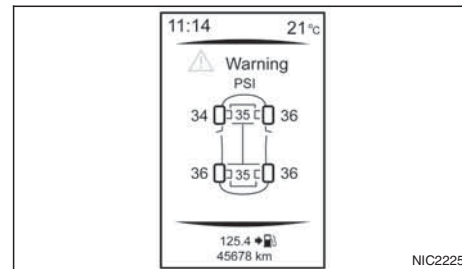

Accordingly, when the TPMS indicator light illuminates, safely stop the vehicle to check the tyres as soon as possible and inflate the tyres to the proper pressure. Driving on a significantly under-inflated tyre causes the tyre to overheat and can lead to tyre failure. Under-inflation also reduces fuel efficiency and tyre tread life which may affect the vehicle's handling and stopping ability.

NOTE

The TPMS is not a substitute for proper tyre maintenance. It is the driver's responsibility to maintain correct tyre pressure, even if under-inflation has not reached the level to trigger the illumination of the TPMS indicator light (a).

The TPMS indicator light flashes for a short period and then turns on continuously if the system is not operating properly. This sequence will continue upon subsequent vehicle start-ups as long as the malfunction exists (missing or faulty TPMS sensor or TPMS system malfunction). When the malfunction warning light is illuminated, the system may not

be able to detect or signal low tyre pressure as intended. TPMS malfunctions may occur for a variety of reasons including the installation of replacement or alternate tyres or wheels on the vehicle that prevent the TPMS from functioning properly. Always check the TPMS indicator light after replacing one or more tyres or wheels on your vehicle to ensure that the replacement or alternate tyres and wheels allow the TPMS to continue to function properly.

- The TPMS does not monitor the tyre pressure of the spare tyre.
- The TPMS will activate only when the vehicle is driven at speeds above 25 km/h (16 MPH). Also, this system may not detect a sudden drop in tyre pressure (for example a flat tyre while driving).
- The TPMS indicator light may not automatically turn off when the tyre pressure is adjusted. **After the tyre is inflated to the recommended COLD tyre pressure**, drive the vehicle at speeds above 25 km/h (16 MPH) to activate the TPMS. See “TPMS sensor ID and position recognition” later in this section
- Following a change in the outside temperature, the TPMS indicator light may illuminate even if the tyre pressure has been adjusted properly. Adjust the tyre pressure to the recommended COLD tyre pressure again when the tyres are cold, and reset the TPMS. For additional information, see “[Check cold tyre] message” later in this section.



WARNING

- If the TPMS indicator light illuminates while driving:
 - avoid sudden steering manoeuvres
 - avoid abrupt braking
 - reduce vehicle speed
 - pull off the road to a safe location
 - stop the vehicle as soon as possible
- Driving with under-inflated tyres may permanently damage the tyres and increase the likelihood of tyre failure. Serious vehicle damage could occur which may lead to an accident and could result in serious personal injury.
- Check the tyre pressure for all four tyres. Adjust the tyre pressure to the recommended COLD tyre pressure shown on the tyre placard to turn the TPMS indicator light “OFF”. In case of a flat tyre, replace it with a spare tyre as soon as possible. (See “Flat tyre” in the “6. In case of emergency” section for changing a flat tyre.)
- When a spare tyre is mounted or a wheel is replaced, the TPMS will not function and the TPMS indicator light will flash for approximately 1 minute. The light will remain on after 1 minute. Be sure to follow all instructions for wheel replacement and mount the TPMS system correctly.

- Replacing tyres with those not originally specified by NISSAN could affect the proper operation of the TPMS.
- The Genuine NISSAN Emergency Tyre Repair Sealant or equivalent can be used for temporarily repairing a tyre. Do not inject any other tyre liquid or aerosol tyre sealant into the tyres, as this may cause a malfunction of the tyre pressure sensors.
- NISSAN recommends using only Genuine NISSAN Emergency Tyre Sealant provided with your vehicle. Other tyre sealants may damage the valve stem seal which can cause the tyre to lose air pressure. Visit a NISSAN dealer or qualified workshop as soon as possible after using tyre repair sealant (for models equipped with the emergency tyre puncture repair kit).

CAUTION

- The TPMS may not function properly when the wheels are equipped with tyre chains or the wheels are buried in snow.
- Do not place metalised film or any metal parts (antenna, etc.) on the windows. This may cause poor reception of the signals from the tyre pressure sensors, and the TPMS will not function properly.

Some devices and transmitters may temporarily interfere with the operation of the TPMS and cause the TPMS indicator light to illuminate. Some examples are:

- Facilities or electric devices using similar radio frequencies are near the vehicle.
 - If a transmitter set to similar frequencies is being used in or near the vehicle.
 - If a computer (or similar equipment) or a DC/AC converter is being used in or near the vehicle.
 - If devices which transmit electrical noise are connected to the vehicle's 12V power supply.
- When inflating the tyres and checking the tyre pressure, never bend the valves.
 - Special aluminium valves are fitted to mount the TPMS sensors on the wheels. The TPMS sensor is fixed at the wheels by a nut. The nut needs to be correctly fitted at a torque setting of $7.5 \pm 0.5 \text{ N}\cdot\text{m}$. If the TPMS sensor is tightened exceeding the limit, there is a possibility the sensor grommet will be damaged. If the sensor is tightened under the limit, there is a possibility of causing an air leak.
 - Use Genuine NISSAN valve caps that comply with the factory-fitted valve cap specifications.
 - Do not use metal valve caps.
- Fit the valve caps properly. Without the valve caps the valve and tyre pressure monitor sensors could be damaged.
 - Do not damage the valves and sensors when storing the wheels or fitting different tyres.
 - Replace the sensor grommet and washer during a tyre change. Once they have been removed, the sensor grommet and washer cannot be reused and must be replaced. The TPMS sensors can be used again.
 - Use caution when using tyre inflation equipment with a rigid air supply tube, as leverage applied by the long nozzle can damage the valve stem.

تلفن شبانه روزی: ۰۲۱-۸۸۸۶۲۰۸۵

FarmaSOS.com

METER INFORMATION

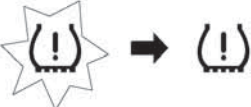
TPMS indicator light(s)	Possible cause	Recommended action
	Low tyre pressure	Inflate tyre(s) to the correct pressure
	Genuine NISSAN TPMS sensor is not detected at one or more wheels	Check if the TPMS sensors are present. If no sensor is present add a genuine NISSAN TPMS sensor
	TPMS radio communication interference between TPMS wheel sensor and TPMS receiver due to external sources.	Drive away from the area of interference
	TPMS parts malfunction	If the problem persists contact a NISSAN dealer or qualified workshop

FarmaSOS.com

ACTIVATION

At ignition ON. Once the vehicle starts moving the tyre pressure is monitored.

TPMS SENSOR ID AND POSITION RECOGNITION

It is recommended that a NISSAN dealer performs the registration of a new TPMS sensor or sensor location.

It is also possible to register the sensor yourself following the procedure below:

Procedure:

1. Change tyre position or have new TPMS sensor fitted.
2. Park with Ignition ON or Engine ON for more than 20 minutes. You must perform this step before driving.
3. Drive the vehicle for several minutes between 25 km/h (16 MPH) and 100 km/h (64 MPH). The TPMS sensor ID and position will automatically be detected.

NOTE

The TPMS might not synchronise if one or more of the following conditions apply:

- Bad road conditions
- The TPMS unit does not receive correct data from tyre pressure sensors
- Driving below 25 km/h (16 MPH)

- Driving above 100 km/h (64 MPH)
- High acceleration
- High deceleration
- In stop and go traffic or traffic waves

ADJUSTING TPMS TARGET PRESSURE

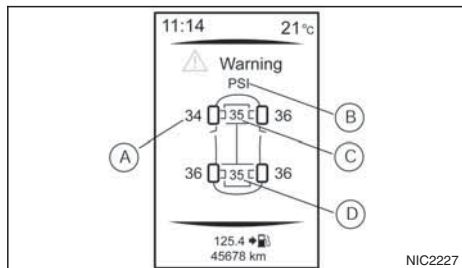

- (A) Tyre pressure
- (B) Tyre pressure units
- (C) Front target pressure
- (D) Rear target pressure

If you are using your vehicle in a heavily laden condition, the tyre pressures should be inflated to the 'Laden Pressure' shown on the tyre placard.

The TPMS system can be adjusted in the vehicle information display to set the target pressure to the 'Laden Pressure' shown on the tyre placard. See "Settings" in the "2. Instruments and controls" section. To adjust the target pressure use the steering

wheel switches to select the [Settings] menu, followed by [Tyre Pressures]. Select [Target front] and [Target rear] and set the desired tyre pressure.

The TPMS target pressures will be displayed in the centre of the front and rear axle on the TPMS screen of the vehicle information display.

TYRE PRESSURE UNITS

The units displayed by the TPMS system can be selected using the vehicle information display. Select the [Settings] menu, followed by [Tyre Pressures]. Select [Tyre pressure unit] and choose the unit that you want.

[CHECK COLD TYRE] MESSAGE

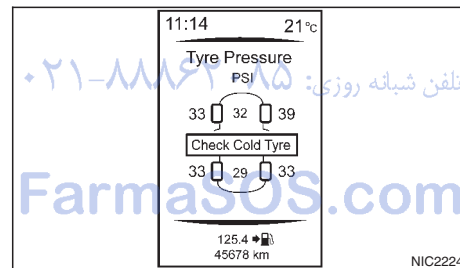

If the tyre pressure becomes higher than the target pressure during a low tyre pressure condition, the [Check Cold Tyre] message will be displayed in the vehicle information display (see "Settings" in the "2. Instruments and controls" section).

NOTE

Even if the pressure is above the preset target pressure, the yellow colour in the tyre pressure warning means that the tyre pressure is actually too low. Tyre pressure is increasing during driving. Check the tyre pressure when the tyre is cold.

TPMS TEMPERATURE CALIBRATION

The tyre pressure is affected by the temperature of the tyre; the tyre temperature increases when the car is driven. To be able to accurately monitor the tyre air leakage and to prevent false TPMS warnings due to reductions in temperature, the TPMS system uses temperature sensors in the tyres to perform temperature compensation calculations.

On rare occasions it may be necessary to recalibrate the TPMS system reference temperature using the vehicle information display. See "Settings" in the "2. Instruments and controls" section. This operation should only be performed when the actual tyre pressure has been adjusted, whilst the current ambient temperature is significantly different to the current calibration temperature.

To initiate TPMS temperature calibration use the steering wheel switches to select the [Settings] menu, followed by [Tyre Pressures]. Select [Calibrate] followed by [Start]. While the calibration process is active, the message: [Resetting tyre pressure system] will be displayed in the vehicle information display.

ON-PAVEMENT AND OFF-ROAD DRIVING PRECAUTIONS

Utility vehicles have a significantly higher rollover rate than other types of vehicles.

They have higher ground clearance than passenger cars to make them capable of performing in a wide variety of on-pavement and off-road applications. This gives them a higher centre of gravity than ordinary cars. An advantage of higher ground clearance is a better view of the road, allowing you to anticipate problems. However, they are not designed for cornering at the same speeds as conventional two-wheel drive (2WD) vehicles any more than low-slung sports cars are designed to perform satisfactorily under off-road conditions. If possible, avoid sharp turns or abrupt manoeuvres, particularly at high speeds. As with other vehicles of this type, failure to operate this vehicle correctly may result in loss of control or vehicle rollover. In a rollover accident an unbelted person is significantly more likely to be injured than a person who is wearing a seat belt.

THREE-WAY CATALYST (Petrol engine models)



NISSAN Blue Citizenship

The three-way catalyst is an emission control device installed in the exhaust system. In the converter, exhaust gases are burned at high temperatures to help reduce pollutants.

CAUTION

- The exhaust gas and the exhaust system are very hot. While the engine is running, keep people or flammable materials away from the exhaust pipe.
- Do not stop or park the vehicle over flammable materials such as dry grass, waste paper or rags, as they may burn easily.
- When parking, ensure that people or flammable materials are kept away from the exhaust pipe.

TO HELP PREVENT DAMAGE

CAUTION

- Use **UNLEADED PETROL ONLY**, specifically the recommended type. For details, see “Capacities and recommended fuel/lubricants” in the “9. Technical information” section.
- Do not use leaded petrol. Leaded petrol will seriously damage three-way catalyst.

Deposits from leaded petrol will seriously reduce the three-way catalyst’s ability to help reduce exhaust pollutants.

- Keep your engine tuned up. Malfunctions in the ignition, fuel injection, or electrical systems can cause over-rich fuel flow into the converter, causing it to overheat.
- Avoid driving with an extremely low fuel level. Running out of fuel could cause the engine to misfire, damaging the three-way catalyst.
- Do not keep driving if the engine misfires, or if noticeable loss of performance or other unusual operating conditions are detected. Have the vehicle inspected promptly by a NISSAN dealer or qualified workshop.
- Do not race the engine while warming it up.
- Do not push or tow your vehicle to start the engine.

TURBOCHARGER SYSTEM (Diesel engine models)

The turbocharger system uses engine oil for lubrication and cooling of its rotating components. The turbocharger turbine turns at extremely high speeds and it can reach an extremely high temperature. It is essential to maintain a flow of clean oil through the turbocharger system. A sudden interruption to the oil supply may cause a malfunction in the turbocharger.

To ensure prolonged life and performance of the turbocharger, it is essential to comply with the following maintenance procedure:

CAUTION

- **Change the engine oil of the turbo-charged diesel engine as prescribed. See the separately provided Warranty Information & Maintenance Booklet for additional information.**
- **Use only the recommended engine oil. See “Capacities and recommended fuel/lubricants” in the “9. Technical information” section.**
- **If the engine has been operating at high rpm for an extended period of time, let it idle for a few minutes prior to shutdown.**
- **Do not accelerate the engine to high rpm immediately after starting it.**

CARE WHEN DRIVING

Driving your vehicle to fit the circumstances is essential for your safety and comfort. As a driver, you should be the one who knows best how to drive in the given circumstances.

ENGINE COLD START PERIOD

Due to the higher engine speeds when the engine is cold, extra caution must be exercised when selecting a gear during the engine warm-up period after starting the engine.

LOADING LUGGAGE

Loads, their distribution and the attachment of equipment (coupling devices, roof luggage carriers, etc.) will change the driving characteristics of the vehicle considerably. Driving style and speed must be adjusted accordingly.

DRIVING ON WET ROADS

- Avoid starting off, accelerating and stopping suddenly.
- Avoid sharp turns or lane changes.
- Extra distance should be kept from the vehicle in front.
- When water covers the road surface in puddles, small streams, etc, **REDUCE SPEED** to prevent aquaplaning which will cause skidding and loss of control. Worn tyres increase this risk.

DRIVING UNDER WINTER CONDITIONS

- Drive safely.
- Avoid starting off, accelerating or stopping suddenly.
- Avoid sharp turns or lane changes.
- Avoid sudden steering actions.
- Extra distance should be kept from the vehicle in front.

IGNITION SWITCH (where fitted)

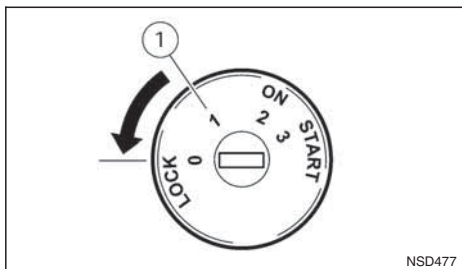

① OFF



WARNING

Never remove the key or turn the ignition switch to the LOCK position while driving. The steering wheel will lock and could cause the driver to lose control of the vehicle. This could result in serious vehicle damage or personal injury.

CAUTION

Use electrical accessories with the engine running to avoid discharging the vehicle battery. If you must use accessories while the engine is not running, do not use them for extended periods of time and do not use multiple electrical accessories at the same time.

The switch includes an anti-theft steering lock device.

MANUAL TRANSMISSION

To lock the steering wheel, turn the ignition switch to the LOCK position and remove the key from the ignition switch, then turn the steering clockwise. To unlock the steering wheel, insert the ignition key and turn it gently while rotating the steering wheel slightly right and left.

The ignition key can only be removed when the switch is in the LOCK position (Normal parking position) (0).

XTRONIC TRANSMISSION (CVT)

The ignition lock is designed so that the key cannot be turned to LOCK and removed until the shift lever is moved to the P (Park) position.

When removing the key from the LOCK position of the ignition switch, make sure that the shift lever is in the P (Park) position.

The shift lever can only be moved from the P (Park) position when the ignition switch is in the ON position and the footbrake pedal is depressed.

To remove the key from the ignition switch:

1. Move the shift lever into the P (Park) position.
2. Turn the key to the LOCK position.
3. Remove the key from the ignition switch.

If the key is removed from the ignition switch, the shift lever cannot be moved from the P (Park) position.

When the key cannot be turned toward the LOCK position, proceed as follows to remove the key:

1. Move the shift lever into the P (Park) position.
2. Turn the key slightly in the ON direction.
3. Turn the key towards the LOCK position.
4. Remove the key.

STEERING LOCK

To lock the steering wheel

1. Turn the key to the LOCK position.
2. Remove the key from the ignition switch.
3. Turn the steering wheel 1/6 of a turn clockwise from the straight up position.

To unlock the steering wheel

1. Insert the key into the ignition switch.
2. Gently turn the key while rotating the steering wheel slightly right and left.

KEY POSITIONS

LOCK (Normal parking position) (0)

The ignition key can only be removed when in this position.

The steering lock can only be locked in this position.

OFF/ACC (Accessories)/(1)

The engine is turned off without locking the steering wheel. This position activates electrical accessories, such as the radio, when the engine is not running.

ON (Normal operating position) (2)

This position turns on the ignition system and electrical accessories.

START (3)

The engine starter activates and the engine will start. As soon as the engine has started, release the key immediately. It will return to the ON position.

NOTE

For vehicles fitted with Stop/Start System:

When the engine is automatically stopped by the Stop/Start System the ignition switch can still be operated as usual.

At the end of a journey turn the ignition OFF to avoid a flat battery. The Stop/Start System does not automatically turn ignition off.

NISSAN ANTI-THEFT SYSTEM (NATS) (where fitted)

The NISSAN Anti Theft System (NATS)* will stop the engine if someone tries to start the engine without using the registered NATS key.

* Immobilizer

If you failed to start the engine using the NATS Key, turn the ignition knob to the LOCK position, wait for 5 seconds and turn the key to the START position again to start the engine.

For additional information, see "NISSAN Anti-Theft System (NATS)" in the "3. Pre-driving checks and adjustments" section.

PUSH-BUTTON IGNITION SWITCH (where fitted)

PRECAUTIONS ON PUSH-BUTTON IGNITION SWITCH OPERATION



WARNING

Do not operate the push-button ignition switch while driving the vehicle except in an emergency. (The engine will stop when the ignition switch is pushed 3 consecutive times in quick succession or the ignition switch is pushed and held for more than 2 seconds.) If the engine stops while the vehicle is being driven, this could lead to a crash and serious injury.

Before operating the push-button ignition switch:

- Move the shift lever to the N (Neutral) position or depress the clutch pedal (for Manual Transmission (MT) models).
- Move the shift lever to the P (Park) position (for XTRONIC transmission (CVT) models).

INTELLIGENT KEY SYSTEM

The Intelligent Key system can operate the ignition switch without taking the key out from your pocket or bag. The operating environment and/or conditions may affect the Intelligent Key system operation.

CAUTION

- Be sure to carry the Intelligent Key with you when operating the vehicle.
- Never leave the Intelligent Key inside the vehicle when you leave the vehicle.

- If the Intelligent Key is too far away from the driver, the vehicle may not start.
- If the vehicle battery is discharged, the ignition switch cannot be switched from the "LOCK" position, and if the steering lock is engaged, the steering wheel cannot be moved. Charge the battery as soon as possible (See "Jump-starting" in the "6. In case of emergency" section.)

Operating range

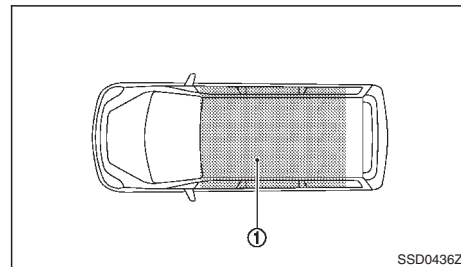

The Intelligent Key can only be used for starting the engine when the Intelligent Key is within the specified operating range ① as illustrated.

When the Intelligent Key battery is almost discharged or strong radio waves are present near the operating location, the Intelligent Key system's operating range becomes narrower and may not function properly.

If the Intelligent Key is within the operating range, it

is possible for anyone, even someone who does not carry the Intelligent Key, to push the ignition switch to start the engine.

- The luggage room area is not included in the operating range, but the Intelligent Key may function.
- If the Intelligent Key is placed on the instrument panel, inside the glove box, door pocket or the corner of the interior compartment, the Intelligent Key may not function.
- If the Intelligent Key is placed near the door or window outside the vehicle, the Intelligent Key may function.

IGNITION SWITCH POSITIONS

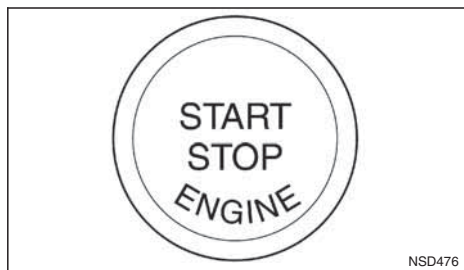

When the ignition switch is pushed without depressing the brake pedal, the ignition switch will illuminate:

Push the centre of the ignition switch:

- Once to change to ON.

- Two times to change to OFF.

The ignition switch will automatically return to the LOCK position when any door is either opened or closed with the switch in the OFF position.

Some indicators and warnings for operation are displayed on the vehicle information display. See "Vehicle information display" in the "Instruments and controls" section of this manual.

ON position (normal operating position)

This position turns on the ignition system and electrical accessories.

ON has a battery saver feature that will turn the ignition switch to the OFF position, if the vehicle is not running, after some time under the following conditions:

- All doors are closed
- Shift lever is in P (Park) (for XTRONIC transmission models).

The battery saver feature will be cancelled if any of the following occur:

- Any door is opened.
- Shift lever is moved out of the P (Park) position.
- Ignition switch changes position.

CAUTION

- **Do not leave the vehicle for extended periods of time when the ignition switch is in the "ACC" or "ON" position and the engine is not running. This can discharge the battery.**

- **Use electrical accessories with the engine running to avoid discharging the vehicle battery. If you must use accessories while the engine is not running, do not use them for extended periods of time and do not use multiple electrical accessories at the same time.**

LOCK position (normal parking position)

The ignition switch and steering lock can only be locked at this position.

The ignition switch will lock when any door is opened or closed with the ignition switched off.

XTRONIC transmission:

The ignition lock is designed so that the ignition switch cannot be switched to the "LOCK" position until the shift lever is moved to the P (Park) position. When pushing the ignition switch to the "OFF" position, make sure the shift lever is in the P (Park) position.

When the ignition switch cannot be switched to the "LOCK" position:

1. Move the shift lever to the P (Park) position.
2. Push the ignition switch. The ignition switch position will change to the ON position.
3. Push the ignition switch again to the LOCK position.

The shift lever can be moved from the P (Park) position if the ignition switch is in the ON position and the brake pedal is depressed.

If the battery of the vehicle is discharged, the push-button ignition switch cannot be moved from the LOCK position.

OFF position

The ignition switch is in the OFF position when the engine is turned off using the ignition switch. No lights will illuminate on the ignition switch.

ACC position

With the vehicle in the P (Park) position, the Intelligent key with you and the ignition placed from ON to OFF, the radio can still be used for a period of time, or until the driver's door is opened.

After a period of time, functions such as radio, navigation, and Bluetooth® Hands-Free Phone System may be restarted by pressing the "POWER button/VOLUME control knob" (See "Monitor, climate, audio, phone and voice recognition systems" in this manual) or the keyfob unlock button up to a total of 30 minutes.

EMERGENCY ENGINE SHUT OFF

To shut off the engine in an emergency situation while driving, perform the following procedure:

- Rapidly push the push-button ignition switch 3 consecutive times in less than 1.5 seconds, or
- Push and hold the push-button ignition switch for more than 2 seconds.

STEERING LOCK

The ignition switch is equipped with an anti-theft steering lock device.

To lock steering wheel

1. Push the ignition switch to the "OFF" position where the ignition switch position indicator will not illuminate.
2. Open or close the door. The ignition switch turns to the "LOCK" position.
3. Turn the steering wheel 1/6 of a turn to the right or left from the straight up position.

To unlock steering wheel

Push the ignition switch to "ACC", and the steering wheel will be automatically unlocked.

CAUTION

- **If the battery of the vehicle is discharged, the push-button ignition switch cannot be switched from the "LOCK" position.**
- **If the ignition switch position does not change from the "LOCK" position, push the ignition switch again while rotating the steering wheel slightly to the right and left.**

INTELLIGENT KEY BATTERY DISCHARGE

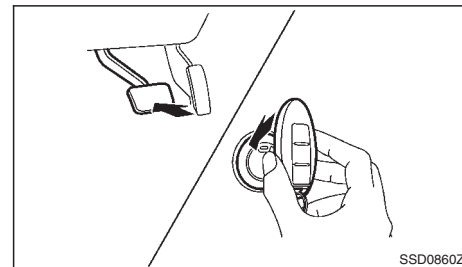

If the battery of the Intelligent Key is discharged, or environmental conditions interfere with the Intelligent Key operation, start the engine according to the following procedure:

1. Move the shift lever to the P (Park) (XTRONIC transmission models) or N (Neutral) (MT models) position.
2. Firmly apply the footbrake.
3. Depress the clutch pedal to the floor (MT models)
4. Touch the ignition switch with the Intelligent Key as illustrated. (A chime will sound.)
5. Push the ignition switch while depressing the brake pedal within 10 seconds after the chime sounds. The engine will start.

STARTING ENGINE

After step 4 is performed, when the ignition switch is pushed without depressing the brake pedal, the ignition switch position will change to "ACC".

NOTE

- When the ignition switch is pushed to the "ACC" or "ON" position or the engine is started by the above procedures, the Intelligent Key system warning light may blink in yellow (on the meter) even if the Intelligent Key is inside the vehicle. This is not a malfunction. To stop the warning light from blinking, touch the ignition switch with the Intelligent Key again.
- If the Intelligent Key system warning light in the meter is blinking in green, replace the battery as soon as possible. (See "Integrated keyfob/Intelligent Key battery replacement" in the "8. Maintenance and do-it-yourself" section.)

MODELS WITH INTELLIGENT KEY SYSTEM

1. Apply the parking brake. For additional information, see "Parking brake switch" in the "3. Pre-driving checks and adjustments" section.

2. Manual transmission models:

Move the shift lever to the N (Neutral) position, and depress the clutch pedal to the floor while starting the engine.

XTRONIC transmission (CVT) models:

Move the shift lever to the P (Park) or N (Neutral) position. (P position is preferred).

The starter is designed to operate only when the shift lever is in the proper position.

- The Intelligent Key (where fitted) must be carried while inside the vehicle when operating the ignition switch.

3. To start the engine:

- MT models – keep the clutch pedal depressed and/or depress the brake pedal then push the ignition switch to the "ON" position.
- XTRONIC transmission models – depress the brake pedal then push the ignition switch to the "ON" position.

NOTE

- To start the engine immediately, push and release the ignition switch while depress-

ing the brake pedal or clutch pedal with the ignition switch in any position.

- For diesel engine models: In cold conditions there may be a delay for a few seconds before the engine cranks. This is due to the glow plugs heating to ensure adequate engine starting conditions. The glow indicator light () will illuminate during this delay, then the engine will start.

4. Immediately release the ignition switch when the engine starts. If the engine starts, but fails to run, repeat the above procedures.

NOTE

Petrol engine models:

- If the engine is very hard to start in extremely cold weather or when restarting, depress the accelerator pedal a little (approximately 1/3 of the way to the floor) and hold it and then crank the engine. Release the ignition switch and the accelerator pedal when the engine starts.
- If the engine is very hard to start because it is flooded, depress the accelerator pedal all the way to the floor and hold it. Crank the engine for 5-6 seconds. After cranking the engine, release the accelerator pedal. Crank the engine with your foot off the accelerator pedal by turning the ignition switch to START. Release the switch when the engine starts. If the engine starts, but fails to run, repeat the above procedure.

CAUTION

- As soon as the engine has started, release the ignition switch immediately.
 - Do not operate the starter for more than 15 seconds at a time. If the engine does not start, turn the ignition switch to the "OFF" position and wait 10 seconds (Petrol engine models) or 20 seconds (Diesel engine models) before cranking again, otherwise the starter could be damaged.
 - If it becomes necessary to start the engine with a booster battery and jumper cables, the instructions and cautions contained in the "6. In case of emergency" section should be carefully followed.
5. After starting, allow the engine to idle for at least 30 seconds to warm-up. Drive at moderate speeds for a short distance first, especially in cold weather.

CAUTION

Do not leave the vehicle unattended while the engine is warming up.

6. To stop the engine:
- Manual transmission models: apply the parking brake and push the ignition switch to the "OFF" position.
 - XTRONIC transmission models: move the shift lever to the P (Park) position, apply the parking brake and push the switch to the "OFF" position.

7. The steering wheel lock engages when ignition is off and a door is opened or closed.

MODELS WITHOUT INTELLIGENT KEY SYSTEM

1. Apply the parking brake. For additional information, see "Parking brake switch" in the "3. Pre-driving checks and adjustments" section.

2. Manual transmission models:

Move the shift lever to the N (Neutral) position, and depress the clutch pedal to the floor while starting the engine.

XTRONIC transmission (CVT) models:

Move the shift lever to the P (Park) or N (Neutral) position. (P position is preferred).

♦ **The starter is designed to operate only when the shift lever is in the proper position.**

3. Rotate the steering wheel left to right to release the ignition lock whilst turning the ignition switch to the ON position.
4. For diesel engine models: Wait until the glow indicator light () goes out.
5. With your foot on the brake pedal, **not on the accelerator pedal**, crank the engine by turning the ignition switch to START.
6. Immediately release the ignition switch when the engine starts. If the engine starts, but fails to run, repeat the above procedures.

NOTE

Petrol engine models:

- If the engine is very hard to start in extremely cold weather or when restarting, depress the accelerator pedal a little (approximately 1/3 of the way to the floor) and hold it and then crank the engine. Release the ignition switch and the accelerator pedal when the engine starts.
- If the engine is very hard to start because it is flooded, depress the accelerator pedal all the way to the floor and hold it. Crank the engine for 5-6 seconds. After cranking the engine, release the accelerator pedal. Crank the engine with your foot off the accelerator pedal by turning the ignition switch to START. Release the switch when the engine starts. If the engine starts, but fails to run, repeat the above procedure.

CAUTION

- As soon as the engine has started, release the ignition switch immediately.
- Do not operate the starter for more than 15 seconds at a time. If the engine does not start, turn the ignition switch to the "OFF" position and wait 10 seconds (Petrol engine models) or 20 seconds (Diesel engine models) before cranking again, otherwise the starter could be damaged.

DRIVING THE VEHICLE

- If it becomes necessary to start the engine with a booster battery and jumper cables, the instructions and cautions contained in the "6. In case of emergency" section should be carefully followed.

7. After starting, allow the engine to idle for at least 30 seconds to warm-up. Drive at moderate speeds for a short distance first, especially in cold weather.

CAUTION

Do not leave the vehicle unattended while the engine is warming up.

8. To stop the engine:
 - Manual transmission models: apply the parking brake and push or turn the ignition switch to the "OFF" position.
 - XTRONIC transmission models: move the shift lever to the P (Park) position, apply the parking brake and push or turn the ignition switch to the "OFF" position.
9. Rotate the steering wheel left to lock the steering wheel.

DRIVING WITH MANUAL TRANSMISSION

CAUTION

- Do not rest your foot on the clutch pedal while driving. This may cause clutch damage.
- Stop your vehicle completely before shifting into the R (Reverse) position.
- When you are shifting from one gear to another, be certain to depress the clutch pedal all the way to the floor to avoid clashing or chipping the gears.
- Avoid abrupt starts and acceleration for your safety.
- When quick acceleration is required for some reason, shift to a lower gear and accelerate until the vehicle reaches the maximum speed in each gear. Do not exceed the speed limit of any gear. Pay special attention when accelerating or when shifting into a lower gear on slippery surfaces. Sudden acceleration or down shifting could cause the wheels to skid and result in loss of control.

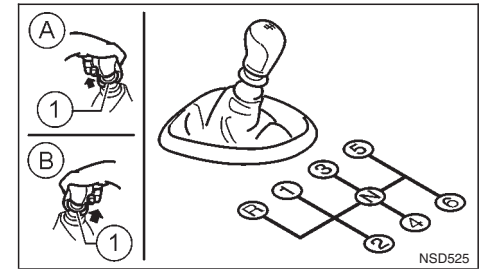

6-speed MT (where fitted)

Shifting

- Ⓐ RHD models
- Ⓑ LHD models
- ① Shift lever ring

To change gears, fully depress the clutch pedal, shift into the appropriate gear, then release the clutch slowly and smoothly.

To ensure smooth gear changes, fully depress the clutch pedal before operating the shift lever. If the clutch pedal is not fully depressed before the transmission is shifted, a grating noise may be heard. This could result in damage to the transmission.

Start the vehicle in 1st gear and shift through the gears in sequence according to the vehicle speed.

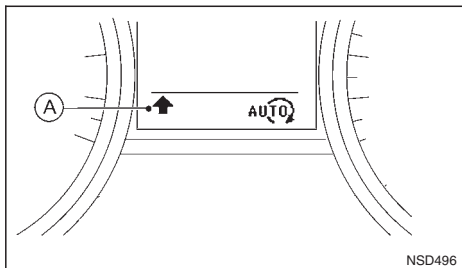

Shift lever indicator (where fitted):

The shift lever indicator (A) located in the lower part of the vehicle information display can help to improve the level of environmentally friendly driving.

Following the shift lever indicator by changing to a higher (or lower) gear whenever the UP (or DOWN) arrow is displayed may improve fuel economy

An UP arrow suggests shifting to a higher gear, a down arrow suggests shifting to a lower gear.

However, the driver remains responsible for deciding the most suitable gear according to actual vehicle, road and traffic conditions.

NOTE

No arrow is displayed in some circumstances including:

- The actual gear matches recommended gear
- The vehicle speed is approx. 0 km/h

Reverse gear:

To reverse with 6-speed manual transmission, proceed as follows:

- 1) Stop the vehicle.
- 2) Move the shift lever into the N (Neutral) position.
- 3) Pull and hold the shift lever ring ① up.
- 4) Move the shift lever into the R (Reverse) position.
- 5) Release the shift lever ring and safely drive the vehicle backwards.

The shift lever ring returns to its original position when the shift lever is moved to the N (Neutral) position.

When the shift lever is in the R (Reverse) position, either the NissanConnect monitor (where fitted) or the ultrasonic parking sensor (where fitted) will be activated. For details, see "Rear-view monitor (where fitted)" or "Around View Monitor (where fitted)" in the "4. Display screen, heater and air conditioner, and audio system" section or "Ultrasonic Parking Sensors (where fitted)" later in this section. For details, see "Ultrasonic Parking Sensors (where fitted)" later in this section.

If it is difficult to move the shift lever into R (Reverse) or 1st. Shift into N (Neutral), then release the clutch pedal. Fully depress the clutch pedal again and shift into R (Reverse) or 1st.

DRIVING WITH XTRONIC TRANSMISSION (CVT)

CAUTION

- The cold engine idle speed is high, so use caution when shifting into a forward or reverse gear before the engine has warmed up.
- Avoid revving up the engine while the vehicle is stopped. This could cause unexpected vehicle movement.

Driving precautions

- Never shift to P (Park) or R (Reverse) while the vehicle is moving, this could result in damage to the transmission.
- Except in an emergency, do not shift to the N (Neutral) position while driving. Coasting with the transmission in the N position may cause serious damage to the transmission.
- Start the engine in the P (Park) or N (Neutral) position. The engine will not start in any other shift lever position. If it does, have your vehicle checked by a NISSAN dealer or qualified workshop.
- Do not depress the accelerator pedal while shifting from P (Park) or N (Neutral) to R (Reverse), D (Drive) or Manual shift modes position. Always depress the brake pedal until shifting is completed.

- On an uphill grade, do not hold the vehicle by depressing the accelerator pedal. The footbrake should be used for this purpose, in order to hold the vehicle in place and to prevent overheating of the transmission.
- Shift into the N (Neutral) position and apply the parking brake when at a standstill for longer than a short waiting period.
- Keep the engine at idling speed while shifting from the N (Neutral) position to any driving position.

CAUTION (when starting the vehicle):

- **DEPRESS THE FOOTBRAKE PEDAL**

When the engine is running, shifting the shift lever into the R (Reverse), D (Drive) or Manual shift mode position without depressing the brake pedal causes the vehicle to move slowly. Be sure the brake pedal is fully depressed and the vehicle is stopped, before shifting the shift lever.

- **BE AWARE OF THE SHIFT LEVER POSITION**

Make sure that the shift lever is in the desired position. Use the D (Drive), or Manual shift mode to move forwards and the R (Reverse) to move backwards. Release the parking brake and the footbrake pedal, then depress the accelerator pedal to start the vehicle in motion and merge with traffic (avoid abrupt starting and spinning the wheels).

- Avoid revving up the engine while the vehicle is stopped, this could cause unexpected vehicle movement [if the shift lever is in the R (Reverse), D (Drive), or Manual shift mode position] or damage the engine [if the shift lever is in the N (Neutral) or P (Park) position].

- **WARM THE ENGINE UP**

Due to the higher idle speeds when the engine is cold, extra caution must be taken when shifting the shift lever into the driving position immediately after starting the engine.

- **PARKING THE VEHICLE**

Depress the footbrake pedal and, once the vehicle stops, move the shift lever into the P (Park) position, apply the parking brake and release the footbrake pedal.

Starting the vehicle

1. After starting the engine, fully depress the footbrake pedal before shifting the shift lever from P (Park) to R (Reverse), D (Drive) or Manual shift mode.
2. Keep the footbrake pedal depressed and push the shift lever button to shift into a driving gear.
3. Release the parking brake and footbrake, then gradually start the vehicle in motion by pressing the accelerator pedal.

The XTRONIC transmission is designed so that the footbrake pedal **MUST** be depressed before shifting from P (Park) to any drive position while the ignition switch is ON.

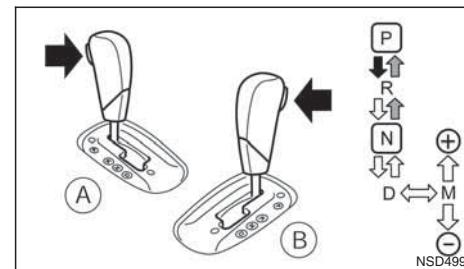

Shifting

Ⓐ LHD models

Ⓑ RHD models

To move the shift lever:

- ➡ Push the button while depressing the brake pedal.
- ⚡ Push the button to shift.
- ⇨ Just move the shift lever.

Push the button to shift into P (Park) or R (Reverse). All other positions can be selected without pushing the button.

P (Park):

Use this position when the vehicle is parked or when starting the engine. Always make sure that the vehicle is completely stopped before moving the shift lever into the P (Park) position. For maximum safety, the footbrake pedal must be depressed before moving the shift lever into the P (Park) position. Use this position together with the parking brake. When parking on a hill, first depress the footbrake pedal, apply the parking brake and then shift into the P (Park) position.

R (Reverse):

CAUTION

Shift into this position only after the vehicle has completely stopped.

Use this position to reverse the vehicle.

When the shift lever is in the R (Reverse) position, either the NissanConnect monitor (where fitted) or the ultrasonic parking sensor (where fitted) will be activated. For details, see "Rear-view monitor (where fitted)" or "Around View Monitor (where fitted)" in the "4. Display screen, heater and air conditioner, and audio system" section or "Ultrasonic Parking Sensors (where fitted)" later in this section.

N (Neutral):

Neither forward nor reverse gear is engaged. The engine can be started in this position. You may shift to N and restart a stalled engine while driving the vehicle.

D (Drive):

Use this position for all normal forward driving.

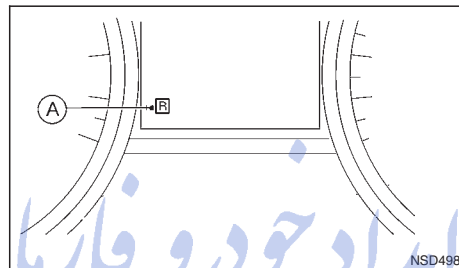

Shift lever indicator:

The shift lever indicator (A) located in the lower part of the vehicle information display shows the current position of the transmission.

It shows the P,R,N,D modes when the transmission is in auto mode or the shift position when the transmission is in manual mode.

Ds (Drive Sport) and Manual shift mode

When the shift lever is shifted from D (Drive) to the manual shift gate with the vehicle stopped or while driving, the transmission enters Ds (Drive Sport) mode. Ds mode will provide improved acceleration response and engine braking. Moving the shift lever forwards and backwards allows manual shifting.

In manual shift mode, the selected gear is displayed on the position indicator in the combination meter.

Shift ranges up or down one by one as follows:

1st ⇔ 2nd ⇔ 3rd ⇔ 4th ⇔ 5th ⇔ 6th ⇔ 7th

- When shifting up, move the shift lever to the + (up) side. (Shifts to higher range).
- When shifting down, move the shift lever to the - (down) side. (Shifts to lower range).
- Moving the shift lever rapidly to the same side twice will shift the ranges in succession.
- Use the 1st position when driving slowly on steep hills, slow driving through deep snow, sand or mud, or for maximum engine braking on steep downhill grades.
- Use the 2nd, 3rd or 4th position when driving steep hills or for engine braking on steep downhill grades.
- Use the 5th position for driving up or down long slopes.
- Use the 6th position for all normal forward driving. However, you need to shift down the gears when accelerating or passing another vehicle.
- When cancelling manual shift mode, return the shift lever to the D (Drive) position. The transmission returns to the normal driving mode.
- **In manual shift mode, the transmission may not shift to the selected gear under certain circumstances. This helps maintain driving performance and reduces the chance of vehicle damage or loss of control.**

- If the engine is revving up to a hazardous speed in manual shift mode, the transmission may shift up automatically. When the vehicle speed decreases, the transmission automatically shifts down and shifts to 1st gear before the vehicle comes to a stop.

Accelerator downshift – In the D (Drive) and Ds (Drive Sport) position

For rapid passing or driving uphill, fully depress the accelerator pedal to the floor. This shifts the transmission down into a lower gear, depending on the vehicle speed.

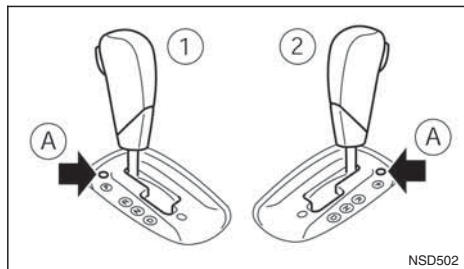

Shift lock release

- ① LHD models
- ② RHD models
- (A) Shift lock release button

If the battery charge is low or discharged, the shift lever may not move from the P (Park) position even with the brake pedal depressed and the shift lever button pushed.

To move the shift lever, perform the following procedure:

1. Models with Intelligent Key system:

Place the ignition switch in the "OFF" or LOCK position.

Models without Intelligent Key system:

Place the ignition switch in the LOCK position, and remove the key if it is inserted.

2. Apply the parking brake.
3. Push down the shift lock release button (A). Use a suitable tool.
4. Push and hold the shift lever button and move the shift lever to the N (Neutral) position while holding down the shift lock release button.

Place the ignition switch in the ON position to unlock the steering wheel. The vehicle may be moved to the desired location.

For models with Intelligent Key system: If the battery is discharged completely, the steering wheel cannot be unlocked. Do not move the vehicle with the steering wheel locked.

If the shift lever cannot be moved out of the P (Park) position, have a NISSAN dealer or qualified workshop check the XTRONIC system as soon as possible.



WARNING

If the shift lever cannot be moved from the P (Park) position while the engine is running and the brake pedal is depressed, the stop lights may not work. Malfunctioning stop lights could cause an accident injuring yourself and others.

High fluid temperature protection mode

This transmission has a high fluid temperature protection mode. If the fluid temperature becomes too high (for example, when climbing steep grades in high temperature with heavy loads, such as when towing a trailer), engine power and, under some conditions, vehicle speed will be decreased automatically to reduce the chance of transmission damage. Vehicle speed can be controlled with the accelerator pedal, but engine and vehicle speed may be limited.

Fail-safe

When the fail-safe operation occurs, the vehicle speed will be decreased automatically to reduce the chance of transmission damage. Vehicle speed can be controlled with the accelerator pedal, but the engine power may be limited. Have a NISSAN dealer or qualified workshop check and repair the transmission.

STOP/START SYSTEM (where fitted)

If the vehicle is driven under extreme conditions, such as excessive wheel spinning and subsequent hard braking, the Fail-safe system may be activated. This will occur even if all electrical circuits are functioning properly. In this case, turn the ignition switch "OFF" and wait for 10 seconds. Then turn the key back to the ON position. The vehicle should return to its normal operating condition. If it does not return to its normal operating condition have your NISSAN dealer or qualified workshop check the transmission and have the transmission repaired by a NISSAN dealer or qualified workshop, if necessary.



WARNING

When the fail safe operation occurs, the vehicle speed may be lower than other traffic, which could increase the chance of a collision. Be especially careful when driving. If necessary, drive to the side of the road at a safe place and away from traffic, to allow the transmission to return to normal operation, or have the transmission repaired by a NISSAN dealer or qualified workshop, if necessary.

The Stop/Start System is designed to prevent unnecessary fuel consumption, exhaust emissions, and noise during a journey:

- When you stop the vehicle with the brake pedal depressed (XTRONIC transmission) or with the shift lever in N (Neutral) and clutch pedal released (MT), the engine is turned off automatically.
- When you release the brake pedal (XTRONIC transmission) or push the clutch pedal (MT), the engine is automatically turned on.

CAUTION

At the end of the journey the engine must be stopped and ignition turned OFF. Lock the vehicle as normal. Turning the ignition OFF will shut down all electrical systems. Failure to do this may result in a flat battery.

NORMAL OPERATION

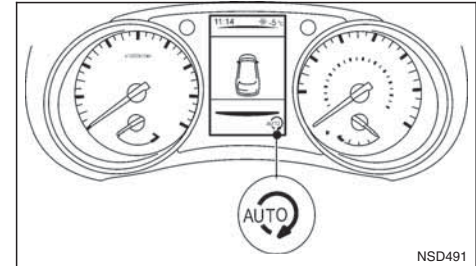

The Stop/Start System has stopped the engine and will automatically restart the engine. The Stop/Start symbol is shown in the vehicle information display.

NOTE

The Stop/Start System will not activate under the following conditions:

- When the engine is kept idling without any driving after the engine is turned on.
- When the engine coolant temperature is low.
- When the battery capacity is low.
- When the battery temperature is low or extremely high.
- When the vehicle is moved.
- When the vacuum in the brake servo decreases.
- When the engine bonnet is opened with the engine running.

- When the engine is turned on with the engine bonnet open.
- When the driver's seat belt is not fastened.
- When the driver's door is open.
- When the steering wheel is operated.
- When the Stop/Start System indicator blinks at a low speed.
- When the accelerator pedal is depressed (XTRONIC transmission models).
- When the shift lever is in the R (Reverse) position.
- When the fan speed control dial is in any position other than "OFF" (0) while the air flow control dial is in the front defogger position (manual air conditioner).
- When the front defogger switch is on (automatic air conditioner).
- When the Stop/Start System OFF switch is turned on.
- When the electric power steering warning light, the Anti-lock Braking System (ABS) warning light, or the Electronic Stability Programme (ESP) warning light illuminates.
- When the brake pedal is not fully depressed (XTRONIC transmission models).
- When stopping the vehicle on steep sloping roads (XTRONIC transmission models).
- When the power consumption is large.

- When the vehicle is travelling at altitudes higher than 2000 m (6562 ft) (MT models).
- When the vehicle is travelling at altitudes higher than 1500m (4922 ft) (R9M engine in combination with XTRONIC transmission models).

NOTE

It may take some time until the Stop/Start System activates under the following conditions:

- When the battery is discharged.
- When the outside temperature is low.
- When the battery is replaced or the battery terminal is disconnected for extended periods and then reconnected.

NOTE

The engine will not restart even if the brake pedal is released (XTRONIC transmission) or clutch pedal is pressed (MT) while the Stop/Start System is activated under the following condition:

- When the shift lever is in the P (Park) position (XTRONIC transmission models).
- When the engine bonnet is opened.
- When the driver seat belt is unfastened and the driver's door is opened (MT models).
- When the gear shift lever is not in the Neutral position. (MT models)

NOTE

The engine will restart without releasing the

brake pedal (XTRONIC transmission models) or without depressing the clutch pedal (MT models) while the Stop/Start System is activated under the following conditions:

- When the Stop/Start System OFF switch is pushed.
- When the fan speed control dial is in any position other than "OFF" (0) while the air flow control dial is in the front defogger position (manual air conditioner).
- When the front defogger switch is set to "ON" (automatic air conditioner).
- When the accelerator pedal is depressed. (XTRONIC transmission models)
- When the steering wheel is operated. (XTRONIC transmission models)
- When the battery capacity is low.
- When the power consumption is large.
- When the brake pedal is released on sloping roads and the vehicle is moved.
- When the force to the brake pedal is reduced while the shift lever is in the D (Drive) or N (Neutral) position. (XTRONIC transmission models)
- When the shift lever is placed in the L (Low), D (Drive) or R (Reverse) position from the N or P position. (XTRONIC transmission models)
- When the vacuum of the brake servo is insufficient as a result of depressing the brake pedal several times.

- When the driver's seat belt is released or the driver's door is open. (XTRONIC transmission models)

Use this system while waiting at stoplight, etc. When the vehicle is stopped for long periods of time, turn off the engine.

When the engine bonnet is opened with the Stop/Start System on, the engine will be in the normal stopped state with the buzzer sounding. In this case, restart the engine with the ignition switch.

When the engine is stopped by the Stop/Start System, heating, cooling and dehumidifying functions will be deactivated. To avoid the air conditioning functions from being deactivated, turn off the Stop/Start System by pressing the Stop/Start System OFF switch.

The Stop/Start System is always engaged at the start of a journey (once the engine has been started). The engine is automatically stopped and restarted during the journey if conditions are suitable. When the engine is stopped the following information is displayed for a few seconds.

See "Vehicle information display" in the "2. Instruments and controls" section for information about the display.



NOTE

Automatic engine restart is possible whenever the Stop/Start System symbol is illuminated at the bottom of the display.

Whilst the engine remains stopped the vehicle information display shows the accumulated quantity (estimate) of carbon dioxide exhaust emissions (where fitted) prevented by the Stop/Start System.

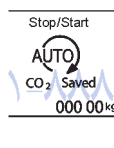

The [CO2 Saved] can be reset in the Settings menu; see "Vehicle information display" in the "2. Instruments and controls" section.

FarmaSOS.com

When automatic restart is not possible the following information is displayed. The engine must be started by turning the ignition switch.



The message can be cleared by pressing the steering wheel  button, restarting the engine, or turning the ignition OFF.

PRECAUTIONS

The following message is displayed when there may be something wrong with the Stop/Start System. You are advised to have the system checked by a NISSAN dealer or qualified workshop.



The message can be cleared by pressing the steering wheel ENTER button

NOTE

The Stop/Start System symbol at the bottom of the display flashes whilst the fault condition remains.

STOP/START SYSTEM OFF SWITCH

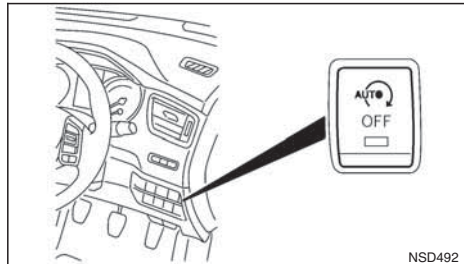

Right hand drive (RHD)

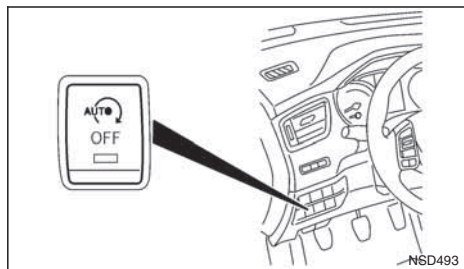

Left hand drive (LHD)

The system can be temporarily disengaged by pressing the Stop/Start System OFF switch. Pressing the button a second time will re-engage the Stop/Start System.

- When the Stop/Start System is disengaged whilst the engine is running, the engine is prevented from automatically stopping.

- When the Stop/Start System is disengaged after the engine has been automatically stopped by the Stop/Start System, the engine will immediately restart if suitable conditions are present as described under NORMAL OPERATION. The engine will then be prevented from automatically stopping during the same journey.
- Whenever the Stop/Start System is disengaged the indicator light on the Stop/Start System OFF switch illuminates. In this condition the Stop/Start System cannot prevent unnecessary fuel consumption, exhaust emissions, or noise during your journey.

NOTE

The following messages may be displayed for a few seconds in the vehicle information display when the Stop/Start System OFF switch is pressed.

Stop/Start System
disengaged

Stop/Start System
re-engaged



More information about the Stop/Start System can be checked using the [Settings] menu (see Instruments and Controls)

ENVIRONMENTAL SAVINGS

The vehicle information display keeps a record of the CO2 savings that can be viewed via the [Settings] menu.

See “Vehicle information display” in the “2. Instruments and controls” section for information about the display.

Information that can be displayed includes:

- [Trip Saving]

Estimated CO2 exhaust emissions prevented since last reset.

NOTE

The [Trip Saving] value is the same information that is displayed when the engine is automatically stopped by the Stop/Start System.

- [Total Saving]

– Estimated CO2 exhaust emissions prevented.

– Time that the engine has been stopped by the Stop/Start System.

NOTE

The [Total Saving] values cannot be reset and show accumulated Stop/Start System information since the vehicle was built.

FOUR-WHEEL DRIVE (4WD) (where fitted)

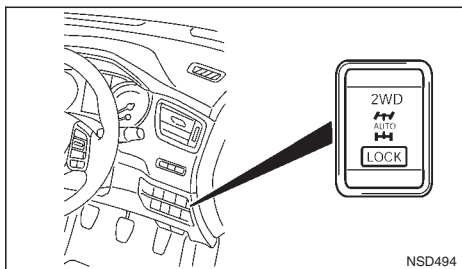

Right hand drive (RHD)

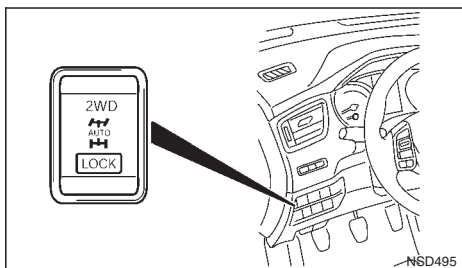

Left hand drive (LHD)

The Four Wheel Drive (4WD) system is used to select 2WD, AUTO, or LOCK depending on the driving conditions.

The Four Wheel Drive (4WD) system controls the coupling operation. Switch the control switch (see illustration) to select each mode: 2WD, AUTO or LOCK depending on the driving conditions.

AUTO: Switch the control switch to the neutral (AUTO) position and the Four-Wheel Drive (4WD) AUTO indicator light  on the combination meter illuminates.



2WD: Switch the control switch to the 2WD position.

LOCK: When the control is switched to the LOCK position, it springs back to the AUTO position when released. The 4WD LOCK mode indicator light  illuminates on the combination meter, to show LOCK mode is engaged. To disengage LOCK mode, switch the control switch again to the LOCK position and release. The 4WD LOCK mode indicator light will go out.

تلفن شبانه روزی: ۰۲۱-۸۸۶۲۰۸۵

FarmaSOS.com

4WD MODE OPERATIONS

4WD Mode	Wheels driven	4WD mode indicator light 	Driving conditions
2WD	Front wheels- The wheel drive mode is in 2WD when driving on a normal road ^{*1}	Goes off	For driving on dry, paved roads
AUTO	Distribution of torque to the front and rear wheels changes automatically, depending on road conditions encountered [ratio; 100:0 (2WD) → 50:50 (4WD)]. This results in improved driving stability		For driving on paved or slippery roads
LOCK	Four wheels ^{*2}		For driving on rough roads

^{*1} The 2WD mode may change to the 4WD mode automatically depending on the driving condition. The 4WD mode indicator light does not illuminate.

^{*2} LOCK mode changes to AUTO mode automatically when the vehicle is sharply accelerated or when the vehicle speed is over approximately 40 km/h (25 MPH). The 4WD LOCK indicator light goes off. Turning off the ignition automatically cancels LOCK mode.

CAUTION

Depending on the driving conditions, the 4WD mode may automatically change from 2WD to 4WD even when the 2WD mode is selected.

If this occurs while driving, the 4WD mode indicator light will not illuminate.

Do not start the engine while in the 2WD, AUTO, or LOCK mode:

- When on free-roller or jacking the front tyres with the rear tyres on the ground.
- When towing with the rear tyres raised from the ground.

4WD SHIFT TIPS

- If the 4WD mode control is operated while cornering, accelerating or decelerating, or if the ignition is turned OFF while in the AUTO or LOCK position you may feel a jolt - this is normal.
- The oil temperature of power train parts will increase if the vehicle is continuously operated under conditions where the difference in rotation between the front and rear wheels is large (wheel slip), such as when driving the vehicle on rough roads through sand or mud, or when freeing a stuck vehicle. In these cases, the message [4WD High Temp. Stop Vehicle] will appear in the vehicle information display and the 4WD mode changes to the 2WD condition to protect the power train parts. If you stop the vehicle, with

the engine idling, and wait until the warning message is no longer displayed, the 4WD mode returns to the AUTO mode.

- Braking distance in 4WD mode is the same as in 2WD mode.
- Even if the mode automatically changes to AUTO mode, when driving in the LOCK mode, the indicator light stays in the LOCK mode.

CAUTION

- **Only use the 4WD mode control when driving in a straight direction (to select 2WD, AUTO or LOCK).**
- **Do not use the 4WD mode control when turning or reversing.**
- **Do not use the 4WD mode control with the front wheels spinning (to select 2WD, AUTO, or LOCK).**
- **Be especially careful when starting or driving on slippery surfaces with the 4WD mode set to AUTO.**
- **Never drive on dry hard surface roads in the LOCK position as this will overload the power train and may cause serious malfunctions.**

4WD MODE INDICATOR LIGHTS

-  4WD mode indicator light (LOCK):
This light comes on when the ignition switch is turned to the ON position, and turns off within 1 second. When selecting LOCK mode while the

engine is running, this light will illuminate simultaneously along with the 4WD mode indicator light (AUTO).

-  4WD mode indicator light (AUTO):

This light comes on when the ignition switch is turned to the ON position, and turns off within 1 second. If the engine is running, this light will illuminate when selecting AUTO mode.

The 4WD mode indicator light is located in the instrument panel.

The light should turn off within 1 second of the ignition switch being turned to the ON position.

While the engine is running, the 4WD mode indicator light will display the position selected by the 4WD mode control.

NOTE تلفن شبانه روزی: ۰۸۵-۸۸۶۲۰۸۱

The 4WD mode indicator light may blink while shifting from one drive mode to another. Once shifting is completed, the 4WD mode indicator light will come on. If the indicator light does not come on immediately, make sure that the area around the vehicle is safe and free from obstacles. Drive the vehicle straight (DO NOT accelerate, decelerate or reverse), then turn the 4WD mode control.

If the 4WD warning lights comes on, the 4WD indicator light(s) will go out.

DRIVING FOUR-WHEEL DRIVE (4WD) SAFELY

Your NISSAN is designed for both normal and off-road use. However, avoid driving in deep water or mud as your NISSAN is mainly designed for leisure use, unlike a conventional off-road vehicle.

Remember that Two-Wheel drive (2WD) models are less capable than Four-Wheel Drive (4WD) models for rough road driving and extrication when stuck, for example, in deep snow or mud.

Please observe the following precautions:

- Drive carefully when off-road and avoid dangerous areas. Always wear seat belts to help keep you and your passengers in position when driving over rough terrain.
- Do not drive across steep slopes. Instead drive either straight up or straight down the slope. Off-road vehicles can tip over sideways much more easily than they can forwards or backwards.
- Many hills are too steep for any vehicle. If you drive up them, you may stall. If you drive down them, you may not be able to control your speed. If you drive across them, you may roll over.
- Do not shift gears when driving on downhill grades as this could cause loss of control of the vehicle.
- Stay alert when driving to the top of a hill. At the top there could be a drop-off or other hazard that could cause an accident.

- If the engine of the vehicle stalls or you cannot make it to the top of a steep grade, never attempt to turn around. Your vehicle could tip or roll over. Always drive backwards and straight down in R (reverse) gear.

Never drive backwards with the shift lever in N (Neutral) and/or with the clutch depressed and using the brake as this could result in loss of control.

- Heavy braking down a hill could cause your brakes to overheat and fade, resulting in loss of control and an accident. Apply the brakes lightly and use a low gear to control your vehicle speed.
- Unsecured cargo can be thrown around when driving over rough terrain. Properly secure it so that it will not be thrown forwards and cause injury to you or your passengers.
- To avoid raising the centre of gravity excessively, do not exceed the rated capacity of the roof rack/gear bin (where fitted) and evenly distribute the load. Secure heavy loads in the luggage area as far forwards and as low as possible. Do not equip the vehicle with tyres larger than specified. This could cause your vehicle to roll over.
- Accelerating quickly, sharp steering manoeuvres or sudden braking may cause loss of control.
- Do not drive beyond the performance of the tyres, even with 4WD. Sudden acceleration, steering or braking may result in loss of control and could cause the vehicle to become stuck.

- If at all possible, avoid sharp turning manoeuvres, particularly at high speeds. Your 4WD vehicle has a higher centre of gravity than a 2WD vehicle and can tip over more easily. The vehicle is not designed for cornering at the same speeds as conventional 2WD models any more than low sports cars are designed to perform satisfactorily under off-road conditions. Failure to operate this vehicle correctly could result in loss of control and/or a rollover accident.

- Do not grip the inside or spokes of the steering wheel when driving off-road. The steering wheel could jerk and injure your hands. Instead, drive with your fingers and thumbs on the outside of the rim.

- Before operating the vehicle, ensure that the driver and all passengers have their seat belts fastened.

- Always drive with the floor mats in place as the floor may become very hot. Particular care should be taken if you are barefoot.

- Lower your speed when encountering strong crosswinds. With its higher centre of gravity your NISSAN is more affected by gusty side winds. Slower speeds ensure better vehicle control.

- Be sure to check the brakes immediately after driving in mud or water as specified in "Wet brakes" later in this section.

- Whenever you drive off-road through sand, mud or water as deep as the wheel hub, more fre-

quent maintenance may be required. For details, refer to the separately provided Warranty Information and Maintenance Booklet.

- Rinse the underside of the vehicle with fresh water after driving through mud or sand. Remove any brush or sticks that are trapped.
- Install the same size of winter tyres on all four (4) wheels (such as studless tyres) or install snow chains to the front wheels when driving on slippery roads (e.g. after a snowfall) and drive carefully using 4WD.
- Avoid parking your vehicle on steep hills. If you get out of the vehicle and it rolls forwards, backwards or sideways, you could be injured.

BLIND SPOT WARNING (BSW) SYSTEM (where fitted)

While driving, the Blind Spot Warning (BSW) system helps alert the driver to the presence of other vehicles in adjacent lanes.

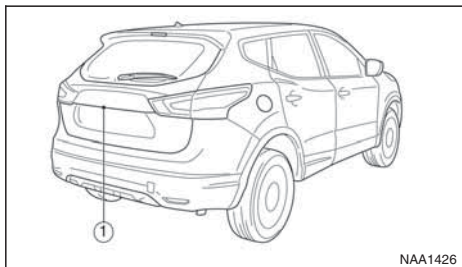

The BSW system uses the rear view monitor camera unit ①.

WARNING

- The BSW system is not a replacement for proper driving procedure and is not designed to prevent contact with vehicles or objects. When driving, always use the side and rear mirrors and always turn your head and look in the direction you will move to ensure it is safe to change lanes. Never rely solely on the BSW system.
- The camera units may not function properly under the following conditions:
 - When towing a trailer.

- When strong light enters the camera unit. (for example, light directly shines on the front or rear of the vehicle at sunrise or sunset.)
- When ambient brightness changes suddenly. (for example, when the vehicle enters or exits a tunnel or passes under a bridge.)
- If the camera lens is excessively dirty, the automatic washer may not be able to completely clean the lens. This could result in the camera not detecting vehicles or lane markers.
- Excessive noise (for example, audio system volume, open vehicle window) will interfere with the chime sound, and it may not be heard.

تلفن شبانه روزی: ۰۲۱-۸۸۶۲۰۸۵

FarmaSOS.com

BSW SYSTEM OPERATION

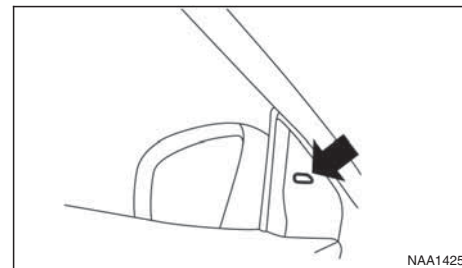

Blind Spot Indicator light on the inside of the mirrors

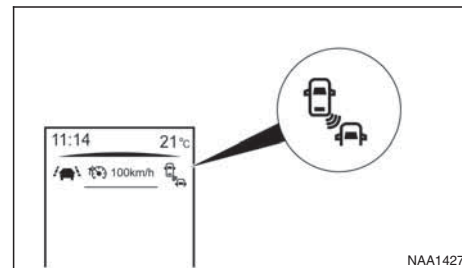

BSW light in the vehicle information display

The BSW system operates above approximately 32 km/h (20 MPH).

The BSW light is shown in the vehicle information display if the Blind Spot Warning system is active. To switch the system on or off, see the description later in this section.

When the camera unit detects a vehicle in the detection zone, the Blind Spot Indicator light located in the front corner of the door window (by the outside

mirrors) will illuminate. If the turn signal is then activated, the system chimes (twice) and the Blind spot indicator light will start flashing bright orange to alert you to the presence of vehicle(s) in the adjacent lane.

The Blind spot indicator light continues to flash until the detected vehicle(s) leave the detection zone.

Detection zone

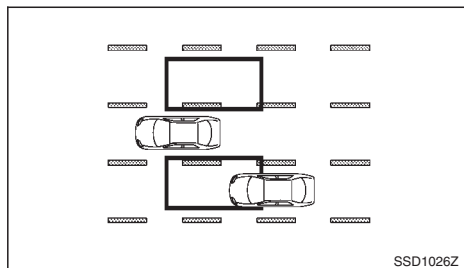

The camera unit can detect vehicles on either side of your vehicle when part of another vehicle is within the detection zone shown as illustrated.

This detection zone typically starts from the outside mirror of your vehicle and extends approximately 3 m (10 ft) behind the rear bumper, and approximately 3 m (10 ft) sideways.

The brightness of the Blind Spot Indicator lights is adjusted automatically depending on the brightness of the ambient light.

A chime sounds if the camera unit has already detected vehicles when the driver activates the turn

signal. If a vehicle comes into the detection zone after the driver activates the turn signal, then only the Blind Spot Indicator light flashes and no chime sounds. (See “BSW driving situations” later in this section.)

Turning the BSW system on or off

Turning the BSW system on or off is done using the [Settings] menu in the vehicle information display. For details, see “Vehicle information display” in the “2. Instruments and controls” section. In the [Settings] menu, select the [Driver Assistance] key. Then select [Driving Aids]. Select [Blind Spot Warning] key by pressing <ENTER>. A tick mark next to [Blind Spot Warning] indicates that the system is turned on.

SYSTEM ON:

The BSW light on the vehicle information display will light up.

SYSTEM OFF:

The BSW light on the vehicle information display will turn off.



WARNING

- The camera unit may not be able to detect when certain objects are present such as:
 - Pedestrians, bicycles, animals.
 - Vehicles such as motorcycles, low height vehicles, or high ground clearance vehicles.
 - Oncoming vehicles.

- A vehicle approaching rapidly from behind. (See “BSW driving situations” later in this section.)
- A vehicle which your vehicle overtakes rapidly. (See “BSW driving situations” later in this section.)
- A vehicle that merges or changes lanes rapidly directly next to your vehicle.
- The camera unit may not be able to detect properly when your vehicle travels beside the middle section of a vehicle with long wheelbase (for example, trailer truck, semi-trailer, tractor).
- The camera detection zone is designed based on a standard lane width. When driving in a wider lane, the camera unit may not detect vehicles in an adjacent lane. When driving in a narrow lane, the camera unit may detect vehicles driving two lanes away.
- The camera unit is designed to ignore most stationary objects, however objects such as guardrails, walls, foliage and parked vehicles may occasionally be detected. This is a normal operating condition.
- The camera unit may detect the reflected image of vehicles or roadside objects that are not actually in the detection zone, especially when the road is wet.

BSW DRIVING SITUATIONS

Another vehicle approaching from behind

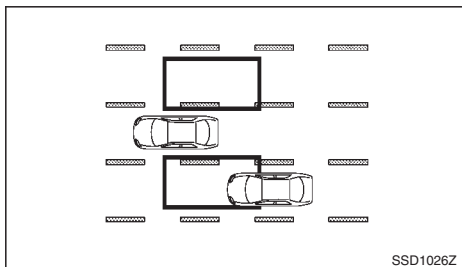

The Blind Spot Indicator light illuminates if a vehicle enters the detection zone from behind in an adjacent lane.

However, if the overtaking vehicle is travelling much faster than your vehicle, the indicator light may not illuminate before the detected vehicle is beside your vehicle.

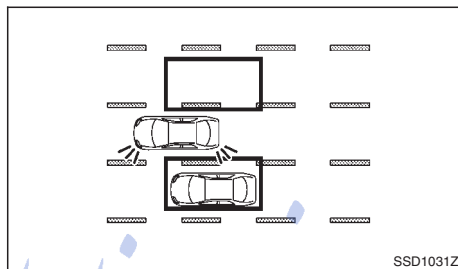

If the driver activates the turn signal, then the Blind Spot Indicator light flashes and a chime will sound twice.

NOTE

If the driver activates the turn signal before a vehicle enters the detection zone, the Blind Spot Indicator light will flash but no chime will sound when the other vehicle is detected.

Overtaking other vehicles

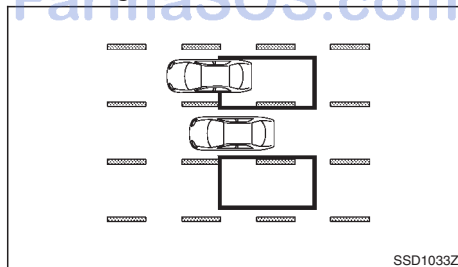

The Blind Spot Indicator light illuminates if you overtake a vehicle and that vehicle stays in the detection zone for approximately 3 seconds.

The camera unit may not detect slower moving vehicles if they are passed quickly.

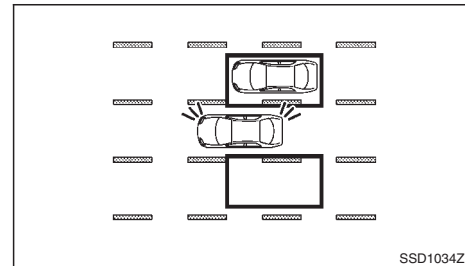

If the driver activates the turn signal while another vehicle is in the detection zone, then the Blind Spot Indicator light flashes and a chime will sound twice.

BSW TEMPORARILY DISABLED STATUS

Under the following conditions the BSW system is turned off temporarily and the BSW light will blink when:

- The back door is open.
- The rear camera lens is dirty.
- Rain, snow or dirt has adhered to the windscreen in front of the multi-sensing camera unit.

When the above conditions are corrected, the BSW system will resume automatically.

BSW AUTOMATIC DEACTIVATION

When dirt, rain or snow accumulates on the rear camera, or the windscreen in front of the multi-sensing camera, the BSW system will be turned off automatically. The BSW light will blink.

Action to take:

If the message appears, park the vehicle in a safe place, clean the camera unit and/or windscreen with a soft cloth. Then turn off and restart the engine.

BSW MALFUNCTION

If the BSW system malfunctions, it will be turned off automatically and the BSW light (orange) will illuminate.

Action to take:

Stop the vehicle in a safe location, turn off and restart the engine. If the BSW light (orange) continues to illuminate, have the BSW system checked by a NISSAN dealer or qualified workshop.

BSW CAMERA UNIT MAINTENANCE

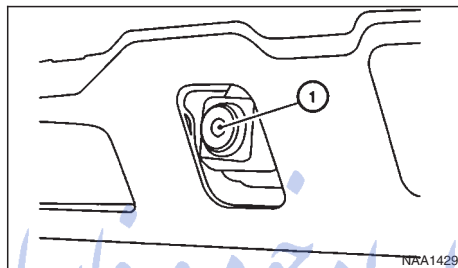

The rear camera unit ① for the BSW system is located above the rear number plate and it has a automatic washer and blower for cleaning the lens. To maintain the proper operation of the BSW system and prevent a system malfunction be sure to observe the following:

- Always keep the camera unit clean. Be careful not to damage the nozzle of automatic washer and blower.
- Do not attach "number plate accessories" that reflect light.
- Do not strike or damage the areas around the camera unit.

LANE DEPARTURE WARNING (LDW) SYSTEM (where fitted)

The Lane Departure Warning (LDW) system alerts the driver when the vehicle is travelling close to either the left or the right of a travelling lane.

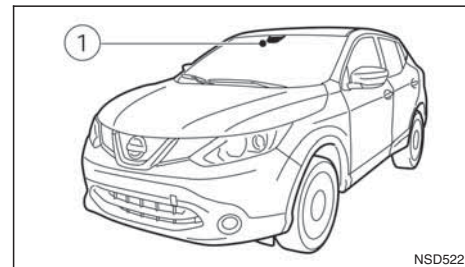

The LDW system uses the multi-sensing front camera unit situated in front of the interior rear view mirror ①.



WARNING

- The LDW system is only a warning device to help inform the driver of a potential unintended lane departure. It will not steer the vehicle or prevent loss of control. It is the driver's responsibility to stay alert, drive safely, keep the vehicle in the travelling lane, and be in control of the vehicle at all times.
- The camera units may not function properly under the following conditions:
 - When towing a trailer.

- When strong light enters the camera unit. (for example, light directly shines on the front or rear of the vehicle at sunrise or sunset.)
- When ambient brightness changes suddenly. (for example, when the vehicle enters or exits a tunnel or passes under a bridge.)
- Excessive noise (for example, audio system volume, open vehicle window) will interfere with the chime sound, and it may not be heard.

LDW SYSTEM OPERATION

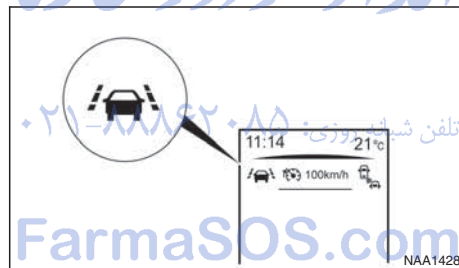
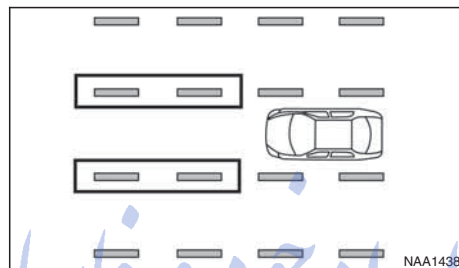

LDW light

The LDW system operates above approximately 60 km/h (37 MPH).

When the vehicle approaches either the left or the right of the travelling lane, the LDW system will chime and the LDW light (orange) in the vehicle information display will blink to alert the driver.

The LDW system is not designed to operate under the following conditions:

- When you operate the lane change signal and change travelling lanes in the direction of the signal. (The LDW system will become operable again approximately 2 seconds after the lane change signal is turned off.)
- When the vehicle speed is less than approximately 60 km/h (37 MPH).

Turning on or off the LDW system

Turning the LDW system on or off is done using the [Settings] menu in the vehicle information display. For details, see "Vehicle information display" in the "2. Instruments and controls" section.

In the [Settings] menu, select the [Driver Assistance] key.

Then select [Driving Aids]. Select [Lane Departure Warning] key by pressing <ENTER>.

A tick mark next to [Lane Departure Warning] indicates that the system is turned on.

SYSTEM ON:

The LDW light in the vehicle information display will light up.

SYSTEM OFF:

The LDW light in the vehicle information display will turn off.



- The camera unit may not be able to detect properly under the following conditions:

- On roads where there are multiple parallel lane markers; lane markers that are faded

or not painted clearly; yellow painted lane markers; non-standard lane markers; or lane markers covered with water, dirt, snow, etc.

- On roads where the discontinued lane markers are still detectable.
 - On roads where there are sharp curves.
 - On roads where there are sharply contrasting objects, such as shadows, snow, water, wheel ruts, seams or lines remaining after road repairs. (The LDW system could detect these items as lane markers.)
 - On roads where the travelling lane merges or separates.
 - When the vehicle's travelling direction does not align with the lane marker.
 - When the road surface is very dark due to weak ambient light or impaired lamps.
 - When rain, snow or dirt adheres to the windscreen in front of the LDW camera unit.
- When driving on a curved road, warning will be late on the outside of the curve.

LDW TEMPORARY DISABLED STATUS

The LDW system is turned off temporarily, and the LDW light will blink when rain, snow, or dirt has adhered to the windscreen in front of the multi-sens-

ing camera unit. When this condition is corrected, the LDW system will resume automatically.

LDW AUTOMATIC DEACTIVATION

When dirt, rain, or snow accumulates on the windscreen in front of the multi-sensing camera unit, the LDW system will be turned off automatically. The LDW light will blink.

Action to take:

If the message appears, park the vehicle in a safe place, clean the camera unit and/or windscreen with a soft cloth. Then turn off and restart the engine.

LDW MALFUNCTION

When the LDW system malfunctions, it will be turned off automatically and the LDW light (orange) will illuminate.

Action to take:

Stop the vehicle in a safe location, turn off and restart the engine. If the LDW light (orange) continues to illuminate, have the LDW system checked by a NISSAN dealer or qualified workshop.

MULTI-SENSING CAMERA UNIT MAINTENANCE

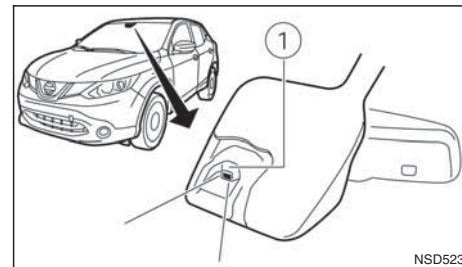

The multi-sensing camera unit ① for the LDW system is located in front of the interior rear view mirror. To maintain the proper operation of the LDW system and prevent a system malfunction be sure to observe the following:

- Always keep the windscreen clean.
- Do not attach a sticker (including transparent material) or install an accessory near the multi-sensing lane camera unit.
- Do not place reflective materials, such as white paper or a mirror, on the instrument panel. The reflection of sunlight may adversely affect the multi-sensing camera unit's detection capability.

CRUISE CONTROL (where fitted)

- Do not strike or damage the areas around the multi-sensing lane camera unit. Do not touch the camera lens or remove the screw located on the camera unit. If the camera unit is damaged due to an accident, contact a NISSAN dealer or qualified workshop.

The cruise control system allows driving at constant speeds without keeping your foot on the accelerator pedal.



WARNING

- The cruise control system **ONLY** maintains a constant vehicle speed, it does not replace the driver.
- Always observe the posted speed limits and do not set the speed above them.
- Do not use the cruise control system when driving under the following conditions. Doing so could cause a loss of vehicle control and result in an accident.
 - When it is not possible to keep the vehicle at a constant speed
 - When driving in heavy traffic
 - When driving in traffic that varies speed
 - When driving in windy areas
 - When driving on winding or hilly roads
 - When driving on slippery (rain, snow, ice, etc.) roads

CAUTION

On manual transmission models, do not shift into N (Neutral) without depressing the clutch pedal when the cruise control is set. Should this occur, depress the clutch pedal and turn the cruise control main switch off immediately. Failure to do so may cause engine damage.

When the cruise control system is on the speed limiter cannot be operated.

The cruise control system operation switches are located on the steering wheel (right side).

The cruise control system operating condition is shown in the vehicle information display.

PRECAUTIONS ON CRUISE CONTROL

- The cruise control system will be automatically cancelled when there is a malfunction. Have the system checked by a NISSAN dealer or qualified workshop.
- To properly set the cruise control system, perform the steps as described in "Setting a cruising speed" later in this section.

CRUISE CONTROL SYSTEM OPERATIONS

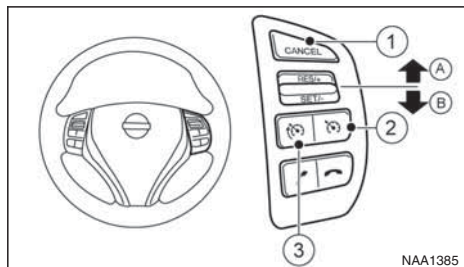

Models with speed limiter (where fitted)

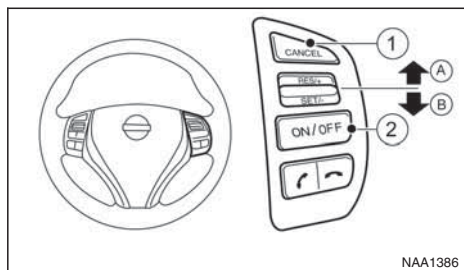

Models without speed limiter

- ① CANCEL switch
- Ⓐ RES/+ (Resume) switch
- Ⓑ SET/- switch
- ② Cruise control main "ON/OFF" switch
- ③ Speed limiter main "ON/OFF" switch

(For details, see "Speed limiter (where fitted)" later in this section) (where fitted)

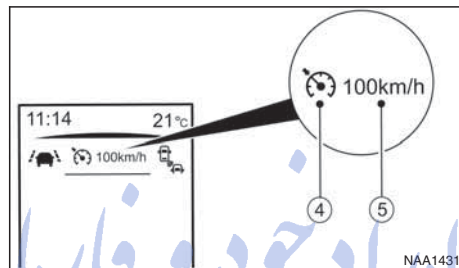

- ④ Cruise control symbol
- ⑤ Set speed value

Turning the cruise control system on

Push the cruise control main switch (2). The cruise control symbol (4) appears together with the last set speed value (or — — —) (5) in the top of the vehicle information display.

Setting a cruising speed

1. Accelerate to the desired cruising speed.
2. Push the SET switch (B) downwards and release it.
3. The cruise control symbol (4) appears together with the set speed value (desired cruising speed) (5) in the top of the vehicle information display.

4. Take your foot off the accelerator pedal.

The vehicle will maintain the set speed.

If the vehicle speed is less than the minimum set speed, it will not be possible to set the cruise control system.

Changing a cruising speed

Use any one of the following methods to change the cruising speed.

- Slow the vehicle as normal using the footbrake pedal.
When the vehicle reaches the desired cruising speed, push and release the SET switch (B) downwards.
The new set speed value will be displayed in the top of the vehicle information display.
- Press the accelerator pedal.
When the vehicle reaches the desired cruising speed, push and release the SET switch (B) downwards.
The new set speed value will be displayed in the top of the vehicle information display.
- Push and release the RES (resume) (A) switch upwards to increase or the SET switch (B) downwards to decrease the set speed in steps of 1 km/h (1 MPH).
The new set speed value will be displayed in the top of the vehicle information display.
- Push and hold the RES (resume) (A) switch upwards or the SET switch (B) downwards. The vehicle speed will increase or decrease to the new set speed.
The new set speed value will be displayed in the top of the vehicle information display.

Passing another vehicle

Depress the accelerator pedal to accelerate. After releasing the accelerator pedal, the vehicle will return to the previously set speed.

The set speed value ⑤ will flash until the vehicle returns to the previously set speed.

Cancelling the cruise control system

To cancel a set speed limit, push the CANCEL switch ①.

The cruise control symbol ④ and the set speed value ⑤ disappear from the top of the vehicle information display.

The cruise control system will also be cancelled automatically by any of the following:

- Pressing the footbrake pedal.
- Pressing the clutch pedal.
- Shifting the shift lever to the N (Neutral) position. First depress clutch pedal
- If the vehicle slows down more than approximately 12 km/h (8 MPH) below the set speed.

Resuming a previous cruising speed

If the cruising speed has been cancelled, the last set speed value will be stored in the cruise control system memory. This cruising speed can be reactivated by pressing the RES (Resume) switch ① upwards.

If the vehicle speed is less than a minimum set speed, it will not be possible to resume to the

cruising speed.

Pressing the CANCEL switch prevents resuming to the previous cruising speed.

Turn the cruise control system off

The cruise control system will be turned off when one of the following operations is performed:

- Push the cruise control main "ON/OFF" switch ②. The cruise control symbol ④ and the set speed value ⑤ will turn off in the combination meter display
- Push the speed limiter main "ON/OFF" switch ③. The cruise control system information in the combination meter will be replaced with the speed limiter information. For details see "Speed limiter (where fitted)" later in this section.
- When the vehicle is stopped and the ignition is turned to the off position.

Turning off the cruise control system will erase the cruise control system memory.

FarmaSOS.com

SPEED LIMITER (where fitted)

The speed limiter allows you to set the desired vehicle speed limit. While the speed limiter is activated, you can perform normal braking and acceleration, but the vehicle will not exceed the set speed.

When the vehicle reaches the set speed limit or if the set speed limit is lower than the actual vehicle speed, the accelerator pedal will not work until the vehicle speed drops below the set speed limit.

When the actual vehicle speed exceeds the set speed, an audible warning will be heard a short time after the set speed is exceeded and driver intervention is not detected.

When the speed limiter is on the cruise control system cannot be operated.



WARNING

- **The speed limiter will not automatically brake the vehicle to the set speed limit.**
- **Always observe posted speed limits. Do not set the speed above them.**
- **Always confirm the setting status of the speed limiter in the vehicle information display.**
- **When the speed limiter is set, avoid hard acceleration to reach the set limit to ensure that the system can limit the speed of the vehicle correctly.**

- When additional floor mats are used, be sure that they are correctly secured and that they cannot interfere with the accelerator pedal. Mats not adapted to the vehicle may prevent proper operation of the speed limiter.

The speed limiter operation switches are located on the steering wheel (right hand side).

The speed limiter operating condition is shown on the top of vehicle information display. For details, see "Vehicle information display" in the "2. Instruments and controls" section.

SPEED LIMITER OPERATIONS

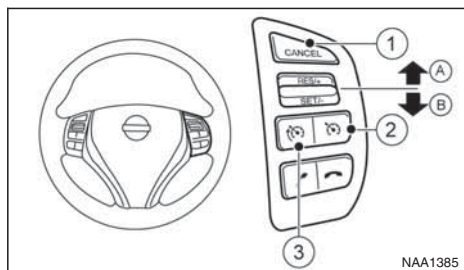

- ① CANCEL switch
- Ⓐ RES + (Resume) switch
- Ⓑ SET - (Set) switch
- ② Cruise control main "ON/OFF" switch. (For details, see "Cruise control (where fitted)" earlier in this section)
- ③ Speed limiter main "ON/OFF" switch

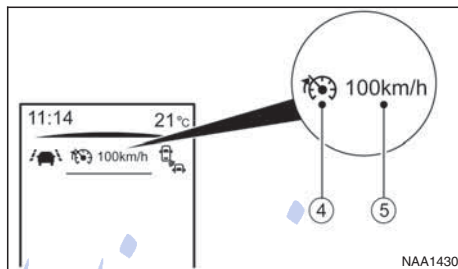

- ④ Speed limiter symbol
- ⑤ Set speed value

Turning the speed limiter on

The speed limiter can be switched on after engine start or when driving.

Push the speed limiter main "ON/OFF" switch ③.

The speed limiter symbol ④ and the set speed value ⑤ will illuminate in the vehicle information display.

Setting speed limit

Push the SET switch Ⓑ (downwards).

Depending on the model:

- The speed limit will be set at the current speed. When driving less than 30 km/h (20 MPH), the speed limiter will be set to the minimum possible set speed of 30 km/h (20 MPH).
- Set the speed limiter while driving over 30 km/h (20 MPH).

When the speed limit is set, the speed limiter symbol ④ and the set speed value ⑤ will illuminate in the vehicle information display. The limiter symbol will turn green.

Changing a speed limit

Use either of the following operations to change an active speed limit:

- Push and release the RES (Resume) switch Ⓐ upwards or SET switch Ⓑ downwards. Each time you do this, the set speed will increase or decrease by 1 km/h (1 MPH).
- Push and hold the RES (Resume) switch Ⓐ upwards or SET switch Ⓑ downwards. The set speed will increase or decrease to the next multiple of 5 km/h (5 MPH) and then in steps of 5 km/h (5 MPH).

The new set speed limit value ⑤ will be displayed in the vehicle information display.

When the actual vehicle speed exceeds the set speed, an audible warning will be heard a short time after the set speed is exceeded and driver intervention is not detected.

Cancelling a speed limit

To cancel a set speed limit, push the CANCEL switch ①. The speed limiter symbol ④ and the set speed value ⑤ in the vehicle information display will be turned off.

It is also possible to override the speed limiter by fully depressing the accelerator pedal beyond the resistance point.



WARNING

- The vehicle may accelerate when the speed limiter cancels.
- When additional floor mats are used, be sure that they are correctly secured and that they cannot interfere with the accelerator pedal. Mats not adapted to the vehicle may prevent proper operation of the speed limiter.

Fully depress the accelerator pedal beyond the resistance point. The speed limiter will be suspended to allow driving above the set speed. The set speed value (5) will flash and an audible warning will sound. The speed limiter will automatically resume when the vehicle speed drops below the set speed limit.

Resuming a previous set speed

If a set speed limit has been cancelled, the set speed will be stored in the speed limiter memory.

This speed limit can be reactivated by pressing the RES (Resume) switch (A) upwards .

If the current vehicle speed is higher than the previous set speed, the accelerator pedal will not work and the set speed value (5) will flash until the vehicle speed drops below the set speed limit.

When the actual vehicle speed exceeds the set speed, an audible warning will be heard a short time after the set speed is exceeded and driver intervention is not detected.

Turning the speed limiter off

The speed limiter system will be turned off when one of the following operations is performed:

- Push the speed limiter main "ON/OFF" switch (3). The speed limiter symbol (4) and the set speed value (5) in the vehicle information display will be turned off.
- Push the cruise control main "ON/OFF" switch (2). The speed limiter information in the vehicle information will be replaced with the cruise control information. For details see "Cruise control (where fitted)" earlier in this section.
- When the vehicle is stopped and the ignition is turned to the off position.

Turning off the speed limiter will erase the set speed limit memory.

Speed limiter malfunction

If the speed limiter malfunctions, the speed limiter symbol (4) in the vehicle information display will flash.

Turn the speed limiter off by pushing the speed limiter main "ON/OFF" switch (3) and have the system checked by a NISSAN dealer or qualified workshop.

FORWARD EMERGENCY BRAKING SYSTEM (where fitted)

The forward emergency braking system can assist the driver when there is a risk of a forward collision with the vehicle ahead in the travelling lane.

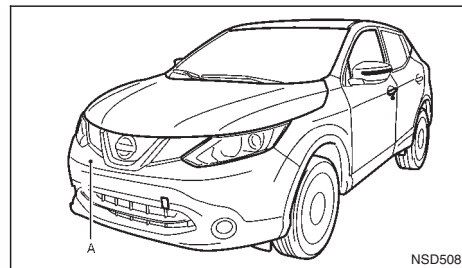

The forward emergency braking system uses a radar sensor (A) located at the front of the vehicle to measure the distance to the vehicle ahead in the travelling lane.



WARNING

- The forward emergency braking system is a supplemental aid to the driver. It is not a replacement for the driver's attention to traffic conditions or responsibility to drive safely. It cannot prevent accidents due to carelessness or dangerous driving techniques.
- The forward emergency braking system does not function in all driving, traffic, weather and road conditions.

SYSTEM OPERATION

The forward emergency braking system will function when your vehicle is driven at speeds above approximately 5 km/h (3 MPH).

If a risk of a forward collision is detected, the forward emergency braking system will provide the first warning to the driver by flashing the forward collision warning light (orange) and providing an audible warning.

If the driver applies the brakes quickly and forcefully after the warning, and the forward emergency braking system detects that there is still the possibility of a forward collision, the system will automatically increase the braking force.

If the driver does not take action, the forward emergency braking system issues the second visual warning (red) and audible warning. If the driver releases the accelerator pedal, then the system applies partial braking.

If the risk of a collision becomes imminent, the forward emergency braking system applies harder braking automatically.

NOTE

The vehicle's brake lights come on when braking is performed by the forward emergency braking system.

Depending on vehicle speed and distance to the vehicle ahead, as well as driving and roadway conditions, the system may help the driver avoid a forward

collision or may help mitigate the consequences if a collision should one be unavoidable.

If the driver is handling the steering wheel, accelerating or braking, the forward emergency braking system will function later or will not function.

The automatic braking will cease under the following conditions:

- When the steering wheel is turned as far as necessary to avoid a collision.
- When the accelerator pedal is depressed.
- When there is no longer a vehicle detected ahead.

If the forward emergency braking system has stopped the vehicle, the vehicle will remain at a standstill for approximately 2 seconds before the brakes are released.



WARNING

- **The radar sensor does not detect the following objects:**
 - Pedestrians, animals or obstacles in the roadway
 - Oncoming vehicles
 - Crossing vehicles
- **The radar sensor has some performance limitations. If a stationary vehicle is in the vehicle's path, the forward emergency braking**

system will not function when the vehicle is driven at speeds over approximately 45 MPH (70 km/h).

- **The radar sensor may not detect a vehicle ahead in the following conditions:**
 - Dirt, ice, snow or other material covering the radar sensor.
 - Interference by other radar sources.
 - Snow or road spray from travelling vehicles.
 - If the vehicle ahead is narrow (e.g. motorcycle).
 - When driving on a steep downhill slope or roads with sharp curves.
 - When towing a trailer.
- **In some road or traffic conditions, the forward emergency braking system may unexpectedly apply partial braking. When acceleration is necessary, continue to depress the accelerator pedal to override the system.**
- **Braking distances increase on slippery surfaces.**
- **Excessive noise will interfere with the warning chime sound, and the chime may not be heard.**
- **The system is designed to automatically check the sensor's functionality, within certain limitations. The system may not detect some forms of obstruction of the sensor area**

of the front bumper such as ice, snow, stickers, for example. In these cases, the system may not be able to warn the driver properly. Be sure that you check, clean and clear the sensor area of the front bumper regularly

Turning the forward emergency braking system ON/OFF

Perform the following steps to turn the forward emergency braking system ON or OFF.

1. Using the ▲ or ▼ switches and the ENTER button on the left side of the steering wheel, select the Settings menu in the vehicle information display. (See "Settings" in the "2. Instruments and controls" section)
2. Using the ▲ or ▼ switches and the ENTER button, navigate to the [Driver Assistance] menu, followed by the [Driving Aids] menu.
3. In the [Driving Aids] menu, highlight the [Emergency Brake] item and use the ENTER button to toggle between ON (enabled) or OFF (disabled).

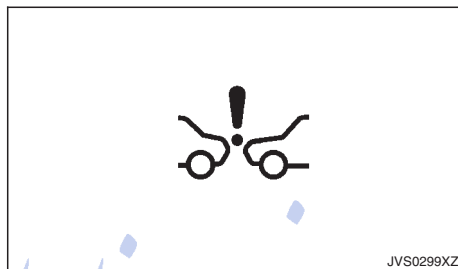

When the forward emergency braking system is turned off, the forward emergency braking system warning light (orange) will illuminate.

System temporarily unavailable

Condition A:

When the radar picks up interference from another radar source, making it impossible to detect a vehicle ahead, the forward emergency braking system is automatically turned off. The forward emergency braking system warning light (orange) and the forward collision warning light (orange) will illuminate.

Action to take:

When the above conditions no longer exist, the forward emergency braking system will resume automatically.

Condition B:

When the sensor area of the front bumper is covered with dirt or obstructed, making it impossible to detect a vehicle ahead, the forward emergency brak-

ing system is automatically turned off. The forward emergency braking system warning light (orange) and the forward collision warning light (orange) will illuminate and the "front radar obstruction" warning message will appear in the vehicle information display.

Action to take:

If the warning light (orange) comes on, park the vehicle in a safe location and turn the engine off. Check to see if the sensor area of the front bumper is blocked. If the sensor area of the front bumper is blocked, remove the blocking material. Restart the engine. If the warning light continues to illuminate, have the forward emergency braking system checked by a NISSAN dealer or qualified workshop.

System malfunction

If the forward emergency braking system malfunctions, it will be turned off automatically, a chime will sound, the forward emergency braking system warning light (orange) and the forward collision warning light (orange) will illuminate and the warning message [Malfunction] will appear in the vehicle information display.

Action to take:

If the warning light (orange) comes on, park the vehicle in a safe location, turn the engine off and restart the engine. If the warning light continues to illuminate, have the forward emergency braking system checked by a NISSAN dealer or qualified workshop.

PARKING



WARNING

- Do not park the vehicle over flammable materials, such as dry grass, waste paper, or rags. They may ignite and cause a fire.
- Safe parking procedures require that:
 - The parking brake is applied.
 - The shift lever is placed in an appropriate gear for manual transmission models.
 - The shift lever is placed in the P (Park) position for XTRONIC transmission (CVT) models.
- Never leave the engine running while the vehicle is unattended.
- Do not leave children or adults who would normally require the support of others alone in your vehicle. Pets should also not be left alone either. On hot, sunny days, temperatures in a closed vehicle could quickly become high enough to cause severe or possibly fatal injuries to people or animals.
- Manual transmission models:

Depress the clutch pedal and place the shift lever in the R (Reverse) position. When parking on an uphill gradient, place the shift lever in the 1st (Low gear) position.

- **XTRONIC transmission models:**

Fully depress the brake pedal and move the shift lever to the P (Park) position.



WARNING

Make sure that the shift lever has been pushed as far forward as it can go and cannot be moved without depressing the button on the shift lever handle.

امداد خودرو فارما

تلفن شبانه روزی: ۰۲۱-۸۸۸۶۲۰۸۵

FarmaSOS.com

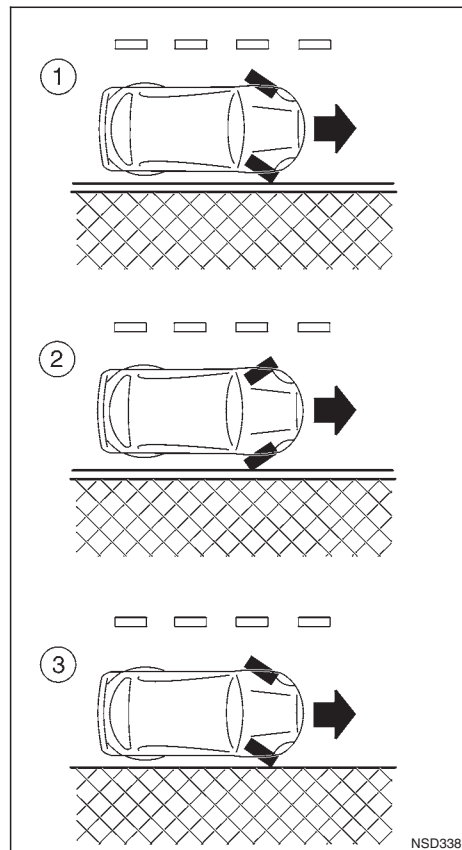

LHD models

NSD338

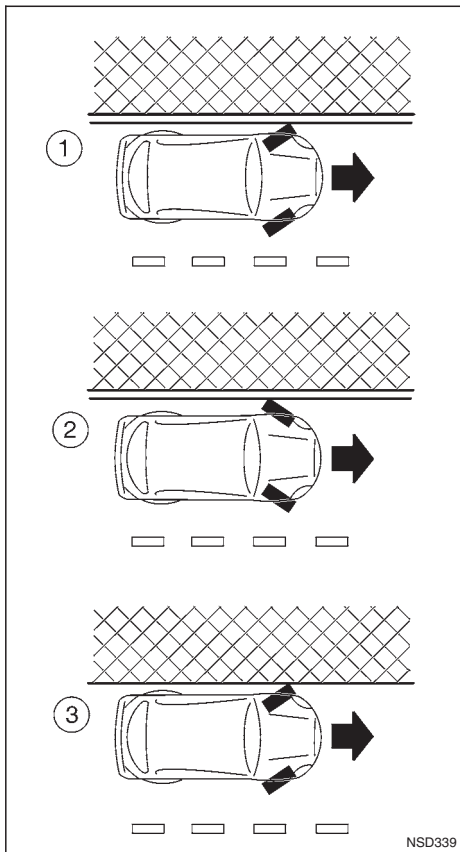

RHD models

NSD339

- When parked on a sloping driveway, turn the wheels so the vehicle will not roll into the street in case it moves.
- **FACING DOWNHILL: ①**
Turn the wheels into the kerb, allow the vehicle to move forward until the kerb side wheel gently touches the kerb. Then set the parking brake.
- **FACING UPHILL: ②**
Turn the wheels away from the kerb and allow the vehicle to move back until the kerb side wheel gently touches the kerb. Then set the parking brake.
- **NO KERB — FACING DOWNHILL OR UPHILL: ③**
Turn the wheels toward the side of the road so the vehicle will move away from the centre of the road if it moves. Then set the parking brake.
- Turn the ignition switch to the LOCK position and remove the key.
- Turn the ignition switch to the LOCK position and remove the key/Intelligent Key (where fitted).
- Always turn off ignition after parking a vehicle with Stop/Start System fitted to avoid a possible flat battery.

NOTE

The Stop/Start System is designed to prevent unnecessary fuel consumption, exhaust emissions and noise during a journey. The Stop/Start System does not automatically turn off ignition at the end of a journey.

ULTRASONIC PARKING SENSORS (where fitted)

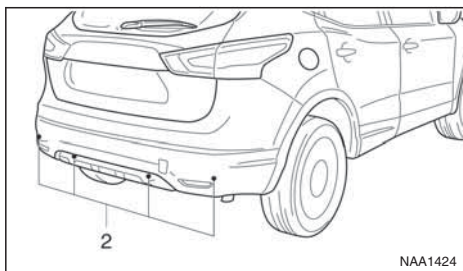
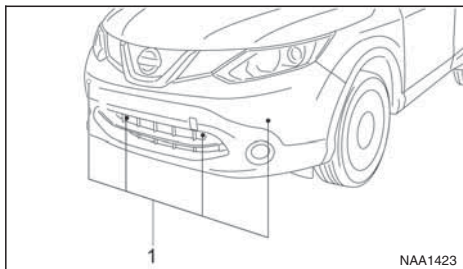

Ultrasonic sensors ① and ②, fitted in the vehicle's front and rear bumpers, measure the distances between the vehicle and an obstacle when reversing. When reverse gear is engaged a top view of the vehicle is shown in the vehicle information display. On the display the distances (1 meter and less) to objects are shown. If the object(s) get(s) closer to the vehicle colours change from green over yellow to red. If the text [STOP] is shown, stop the vehicle before actually touching the object.

WARNING

If there is any doubt the surroundings in the path of the parking area and/or the parking area itself are not free from obstacles immediately stop the vehicle and check.

NOTE

- This system is intended as an aid to parking, to be used in conjunction with your rear view mirror.
- Make sure that the ultrasonic sensors are not obscured (by dirt, mud, snow, etc.).

تلفن شبانه روزی: ۰۲۱-۸۸۸۶۲۰۸۵

FarmaSOS.com

OPERATION

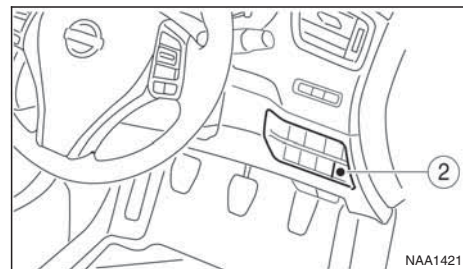
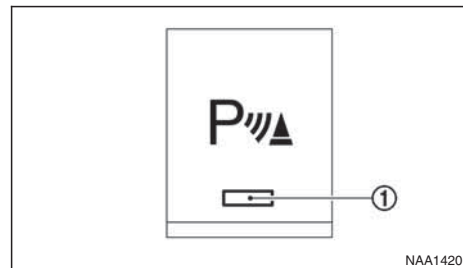

Switch the system on or off by pressing the parking sensor system button ②

If the [Display] key in the [Parking Aids] menu is selected (marked by the green marker) and R (Reverse) is engaged, the parking sensor display is shown automatically without first pressing the button.

Using the settings menu

The settings of the parking sensor system can be changed.

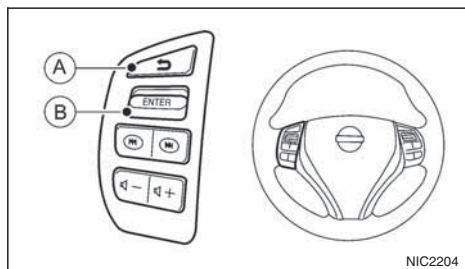

At ignition on (the [Settings] menu is shown in the display), select [Driver Assistance] —> [Parking Aids], press the <ENTER> switch (B) on the steering wheel. Press the BACK switch (A) to return to the previous item.

The settings menu is shown

Set the following items on or off by selecting (highlighted) and pressing the <ENTER> (B) switch on the steering wheel. When selected a green marker is shown.

- [Front sensor]:
Switch the front sensors on or off
- [Rear sensor]:
Switch the rear sensors on or off

- [Display]:
Switch the parking sensor system automatically on or off when selecting R (Reverse) gear.

By highlighting the colour of the to be set item:

- Set the volume of the parking sensor system
Select [Volume] and press <ENTER>
 - High
 - Med.
 - Low
- Set the range sensitivity
Select [Range] and press <ENTER>
 - Far
 - Mid.
 - Near

FarmaSOS.com

INTELLIGENT PARKING ASSIST (IPA) (where fitted)



WARNING

Intelligent Parking Assist (IPA) is a guidance system for parking procedures. It does not prevent collisions with objects. Always look through the windows and check to be sure that it is safe to move.

The Intelligent Parking Assist (IPA) system controls steering, guiding the vehicle when parking:

- In a bay
- Parallel to the road

NOTE

The IPA system instructs you to stop, drive forwards or drive backwards. Follow the instructions given by the system.

The IPA system is not able to support parking when the vehicle speed during the parking manoeuvre is more than 7 km/h (4 MPH).

CAUTION

Do not use the IPA system under the following conditions:

- On unpaved roads.
- On snow-covered or frozen roads.
- On uneven roads with slants, bumps, kerbstones, wheel tracks, etc.
- At mechanical parking facilities.
- When tyre chains or a spare tyre are installed.

- When the vehicle is being towed
- When the doors (including the back door) are not closed.

The following conditions may reduce the ability of the system to detect other vehicles:

- Severe weather.
- Road spray.
- Ice build up on the vehicle.
- Frost on the vehicle.
- Dirt on the vehicle.

Do not attach stickers (including transparent material), install accessories or apply additional paint near the sonar sensors. These conditions may reduce the ability of the system to detect other vehicles.

The sonar sensors detect stationary objects behind the vehicle. The sonar sensors may not detect:

- Small or moving objects.
- Wedge-shaped objects.
- Objects close to the bumper.
- Thin objects such as rope, wire, or chain.

NOTE

Under the following conditions, the IPA may not be able to predict precise courses and function properly. There may be instances where sur-

rounding objects and vehicles are displayed inside the clearance guidelines (red), or where the vehicle cannot be parked in the correct spot following the IPA operation.

- When the shift lever is operated while driving.
- When sudden start, sudden stop or sudden operation of the shift lever occurs.
- When tyre pressure is too low or a tyre is worn out.
- When tyres are installed that are of a different size from the tyres that were equipped at the time of factory shipment.
- When the vehicle is heavily laden.

DEACTIVATION OF THE IPA SYSTEM

The IPA will deactivate under the following conditions:

- When the steering wheel is operated manually.
- When 5 seconds have passed since the shift lever was placed and kept in the Neutral (N) position.
- When reversing operations are conducted more than 10 times for steering corrections.
- When the system judges that conditions (such as worn out or low pressure tyres, road conditions for example) are not suitable for correct course predictions.
- When the vehicle reverses to a position behind the position where the IPA operation started.

- When the vehicle passes the reverse starting position by more than 2 m (6.5 ft).
- When the vehicle speed exceeds approximately 7 km/h (4 MPH).
- When the driver does not follow the IPA guidance.

PARKING PROCEDURE USING THE IPA SYSTEM

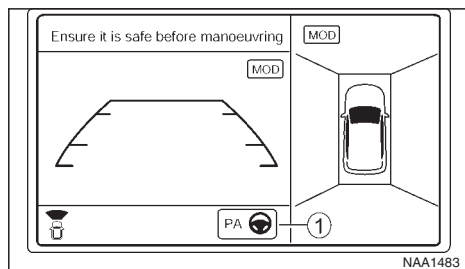

RHD models

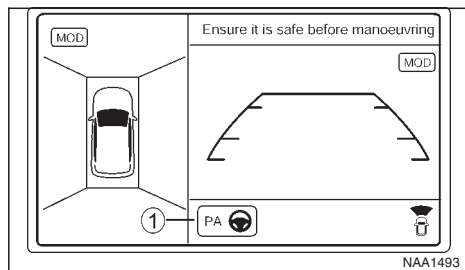

LHD models

Using the lines and rectangles displayed on the screen and the voice guidance, the system provides step-by-step instructions for parking. The IPA button **PA** (1) is located in the lower centre of the screen (1).

Parallel parking

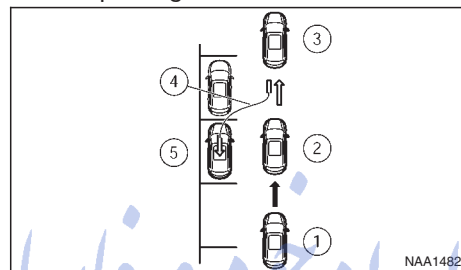

Parallel parking procedure

1. Stop the vehicle in the road where you want to find a parking place.

Press the <CAMERA> button to display the Around View Monitor on the centre display.

Press the IPA button **PA** (1).

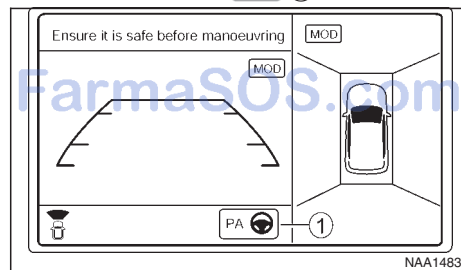

NOTE

If necessary, press the **PA** button (2) to switch to parallel parking.

2. The parallel parking mode is displayed. On one side of the screen a scanning area is indicated (A).

The IPA system will show the [Use turn signal to switch side] text in the other side of the screen.

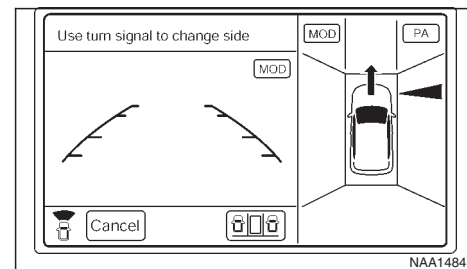

NOTE

Use the turn signal switch to select the side of the vehicle the IPA system should use to find a parking space. The scanning area (A) will switch sides, depending upon the position of the turn signal switch.

Drive the vehicle forward at a steady pace alongside the row of parked vehicles. The system will search for a parking space. The IPA system will

inform you when it finds a suitable parking space between the parked vehicles. You will be told to drive a short distance past the parking space, and then stop.

3. Slowly move the vehicle forward to the correct position until the IPA system instructs you to stop.



WARNING

If there is any doubt that the surroundings in the path of the parking area and/or the parking area itself are not free from obstacles immediately stop the vehicle and check.

NOTE

Make sure the vehicle is stopped completely before shifting the shift lever to the Reverse (R) position.

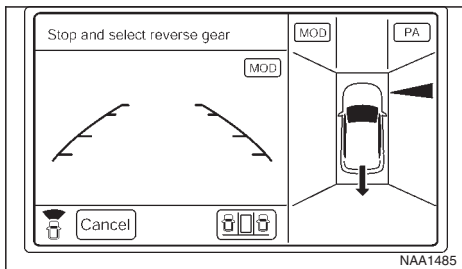

4. Follow the instructions given by the system. Place the shift lever in the Reverse (R) position.

Gently place your hands on the steering wheel and slowly reverse towards the parking space.

The steering will be operated automatically. Carefully and slowly accelerate while checking the surroundings. Do not turn the steering wheel. The system indicates when the parking procedure has ended.

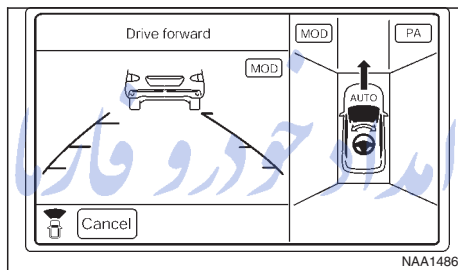

NOTE

- Only the steering operates automatically.
- Follow the instructions given by the system.
- Carefully and slowly accelerate while checking the surroundings.
- Use of the steering wheel will cancel the IPA operation.

5. When the vehicle is in the target parking position, check, then depress the brake pedal to stop the vehicle.

When the vehicle reaches the approximate area

of the target parking space, a chime will sound, "[Park assist finished]" will appear on the centre display and the IPA operation will automatically terminate.

Make any final adjustments that may be necessary manually, after confirming the vehicle's surroundings.

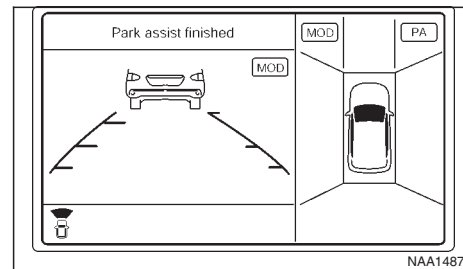

NOTE

The system can be cancelled at any time:

- By placing the shift lever in the Park (P) position for vehicles with XTRONIC transmission.
- By placing the shift lever in the Neutral (N) position for MT vehicles.
- By overriding the steering manoeuvre.
- By pressing the [Cancel] button on the centre display.

Parking in a bay

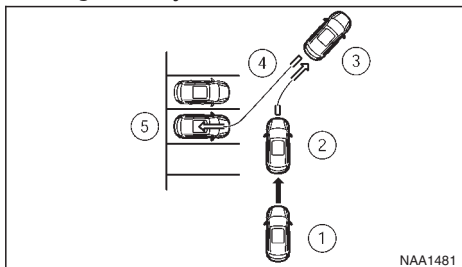

Bay parking procedure

1. Stop the vehicle near to the space where you wish to park.
2. Press the <CAMERA> button, followed by the IPA button **PA**.

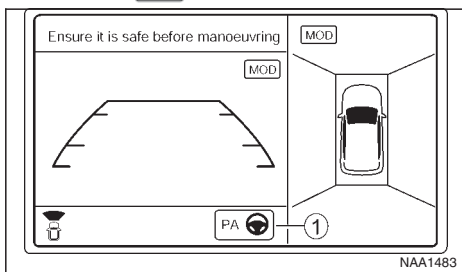

NAA1483

NOTE

If the bird's-eye view is not displayed on the front passenger side of the screen, press the <CAMERA> button until the bird's-eye view is displayed.

The IPA system will show the [Use turn signal to switch side] text.

NOTE

Use the turn signal switch to select the side of the vehicle where the parking bay is situated. The scanning area (A) will switch sides, depending upon the position of the turn signal switch.

3. Press the  button (2) to switch to bay parking.

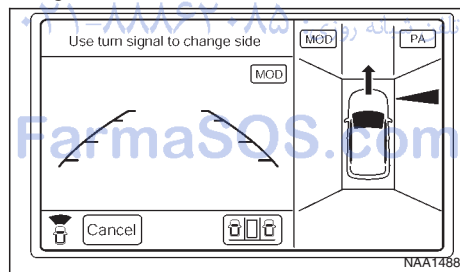

NAA1488

4. The bay parking mode is displayed.

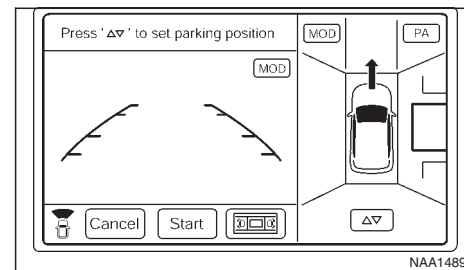

NAA1489

Stop vehicle alongside, and approximately 1 m (3 ft) from the parking place.

On one side of the screen the rear camera view is shown.

On the other side of the screen, the blue lines indicate the target parking area (1).

Touch the  button (2).

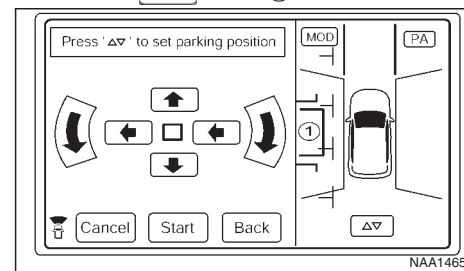

NAA1485

Adjust the target parking rectangle ① (blue) using the arrow keys on the screen so that the clearance guidelines do not overlap any obstacles around the vehicle.

CAUTION

After pressing [Start] the vehicle will park within the blue area. Make sure this area is free of obstacles.

5. Press [Start].

The vehicle starts the parking procedure. The IPA operation can be started when the following conditions are met:

- The vehicle is completely stopped.
- The steering wheel is in the straight-ahead position.
- The shift lever is in the Drive (D) or a forward shift position.

NOTE

If the vehicle deviates from the parking rectangle while following the parking procedure, stop and adjust the position.



WARNING

If there is any doubt that the surroundings in the path of the parking area and/or the parking area itself are not free from obstacles immediately stop the vehicle and check.

6. Gently place hands on the steering wheel and slowly move forward the vehicle to the correct position indicated in green in preparation for reversing.

Bring the vehicle to a standstill

The steering wheel will operate itself towards the reverse starting position (green).

Depress the brake and stop the vehicle when it approaches another vehicle or object, or when the vehicle reaches the reverse starting position.

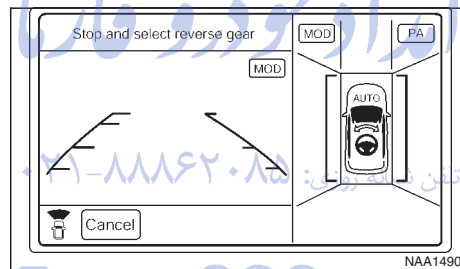

7. Place the shift lever in the Reverse (R) position

Gently place hands on the steering wheel and slowly back up to the parking space

Steering will be operated automatically.

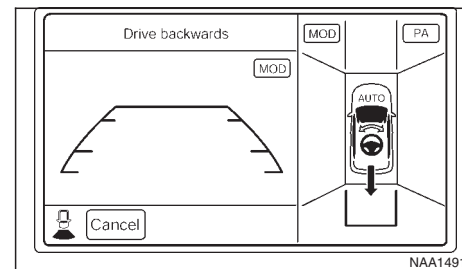

NOTE

- Only the steering operates automatically.
 - Follow the instructions given by the system.
 - Carefully and slowly accelerate while checking the surroundings.
 - Use of the steering wheel will cancel the IPA operation.
8. When the vehicle is in the target parking position, check, then depress the brake pedal to stop the vehicle.

When the vehicle reaches the approximate area of the target parking space, a chime will sound, "[Park assist finished]" will appear on the centre display and the IPA operation will automatically terminate.

Make any final adjustments that may be necessary manually, after confirming the vehicle's surroundings.

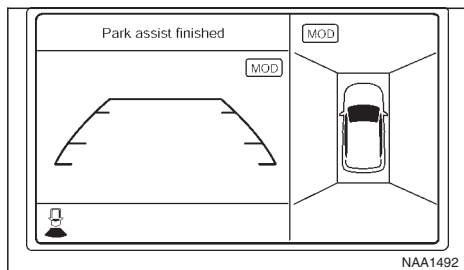

NOTE

The system can be cancelled at any time:

- By placing the shift lever in the Park (P) position for vehicles with XTRONIC transmission.
- By placing the shift lever in the Neutral (N) position for MT vehicles.
- By overriding the steering manoeuvre.
- By pressing the [Cancel] button on the centre display.

OPERATING TIPS

- The screen displayed on the Around View Monitor will automatically return to the previous screen three minutes after the <CAMERA> button has been pushed while the shift lever is in a position other than the Reverse (R) position.

- When the view is switched, the display of images on the screen may be displayed with some delay.
- When the temperature is extremely high or low, the screen may not display objects clearly. This is not a malfunction.
- When strong light directly shines on the camera, objects may not be displayed clearly. This is not a malfunction.
- The screen may flicker under fluorescent light. This is not a malfunction.
- The colour of objects on the Around View Monitor may differ somewhat from the actual colour of objects. This is not a malfunction.
- Objects on the monitor may not be clear and the colour of the object may differ in a dark environment. This is not a malfunction.
- There may be differences in sharpness between each camera view of the bird view.
- If dirt, rain or snow accumulates on the camera, the Around View Monitor may not display objects clearly. Clean the camera.
- Do not use alcohol, benzine or thinner to clean the camera. This will cause discoloration. To clean the camera, wipe with a cloth that has been dampened with a diluted mild cleaning agent and then wipe with a dry cloth.
- Do not damage the camera because the monitor screen may be adversely affected.
- Do not use wax on the camera lens. Wipe off any wax with a clean cloth that has been dampened with a mild detergent diluted with water.
- An intermittent tone will be heard when the vehicle is moving during the guidance, and the chime will ring when the vehicle comes to the target position in each step. Stop the vehicle when the chime rings and follow the next guidance.
- Depending on the situation, multiple parking manoeuvres may be required.

How to read displayed guide lines

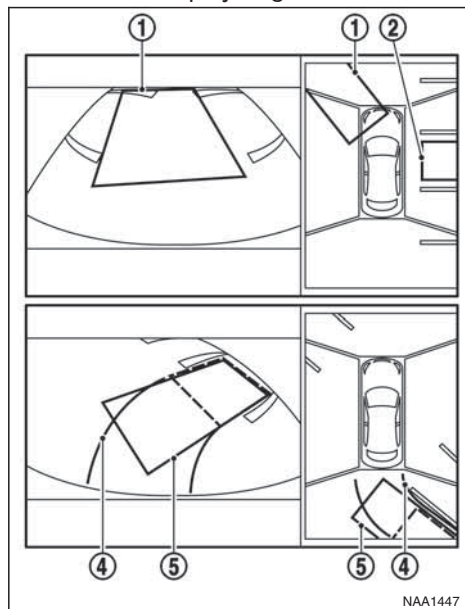

Starting position rectangle for reversing ① (Green):

Indicates the starting position for reversing. The position and colour of the rectangle will be changed according to the steering angle.

- Green: Indicates the recommended position.

- Yellow: Indicates that multiple parking manoeuvres will be required.
- Red: Indicates that parking guidance is not available. Driver must park without guidance.

Target parking rectangle ② (Blue):

Indicates the target parking position.

Clearance guidelines ③ (Red):

Indicate locations of the obstacles that set the approximate space required for parking.

Target course lines ④ (Green):

Indicate the course needed to park the vehicle into the target parking position.

Predictive course lines ⑤ (Orange):

Indicate the predictive course when operating the vehicle.

Predictive course lines move when the steering wheel is rotated. Turn the steering wheel until the predictive course lines overlap with the target course lines.

IPA malfunction

A warning message will be displayed and the system will terminate operation if a malfunction is detected in the IPA.

If the warning message is displayed during the IPA operation, park the vehicle in a safe place and restart the engine.

If the warning message is shown on the display repeatedly or if the IPA cannot be operated after

restarting the engine, this may indicate a system malfunction. It should not hinder normal driving, but the vehicle should be inspected by a NISSAN dealer or qualified workshop.

TRAILER TOWING

Your new vehicle was designed to be used primarily to carry passengers and luggage.

Remember that towing a trailer will place additional loads on your vehicle's engine, drive-train, steering, braking and other systems. Towing a trailer will also exaggerate other conditions, such as sway caused by crosswinds, rough road surfaces or passing trucks. Driving style and speed must be adjusted according to the circumstances. Before towing a trailer, see a NISSAN dealer or qualified workshop for an explanation of towing equipment and its proper use.

OPERATING PRECAUTIONS

- Avoid towing a trailer during the running-in schedule.
 - Choose proper coupling devices (trailer hitch, safety chain, roof carrier, etc.) for your vehicle and trailer. These devices are available from a NISSAN dealer or qualified workshop where you can also obtain more detailed information about trailer towing.
- Heavy-duty kits are available at a NISSAN dealer or qualified workshop.
- It is advisable to contact a NISSAN dealer or qualified workshop for towing details, before towing a trailer up steep slopes for long distances.
 - Never allow the total trailer load (trailer weight plus its cargo weight) to exceed the maximum set for the coupling device.

Contact a NISSAN dealer or qualified workshop for more information on this matter.

- The trailer must be loaded so that heavy goods are distributed over the axle and as low in the trailer as possible. Poor load distribution can seriously affect the stability of the trailer and tow vehicle.
- Do not exceed the maximum permitted vertical load on the trailer hitch.
- Before driving, make sure that the lighting system of the trailer works properly.
- When towing with 4WD models, the 4WD mode switch should be in the AUTO position. Using the vehicle in AUTO mode gives better traction, particularly when moving off from stationary and/or on an incline, as the vehicle is less likely to wheel spin.
- Avoid abrupt starts, accelerations and stops.
- Avoid sharp turns and lane changes.
- Always drive your vehicle at a moderate speed.
- Always block the wheels on both vehicle and trailer when parking. Apply the handbrake (where fitted) on the trailer. Parking on a steep slope is not recommended.

If parking on a steep slope is unavoidable it is also advisable to put the vehicle into gear, or select P (Park (XTRONIC models)), and turn the front wheels into the kerb (in addition to the other precautions described). Before parking on a

steep slope consider the incline (the towing weights quoted are for a 12% slope).

- Follow the trailer manufacturer's instructions.
- Have your vehicle serviced more often than at the intervals specified in the separately provided Warranty Information and Maintenance booklet.
- Trailer towing requires more fuel than under normal circumstances because of a considerable increase in traction power required and resistance.
- When towing a trailer, observe the following restricted towing speed:
Speed: below 100 km/h (62 MPH)
- Observe the legal maximum speeds for trailer operation.

CAUTION

While towing a trailer, check the engine coolant temperature gauge regularly to prevent engine overheating.

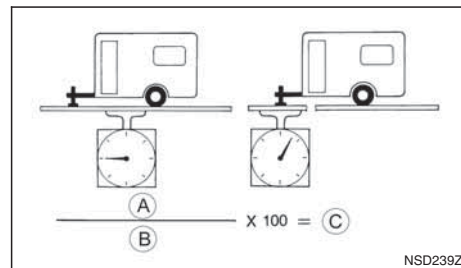

- (A) Tongue load
- (B) Total trailer load
- (C) Less than 10%

MAXIMUM LOAD LIMITS (for Australia)

Maximum trailer loads (including tyres and other loaded equipment):

- 1) Never allow the total trailer load to exceed:

Engine – Transmission	Axle	Towing capacity
R9M – CVT	2WD	750 kg Trailer without brakes 1400 kg Trailer with brakes
MR20DD – 6MT	2WD	716 kg Trailer without brakes 1400 kg Trailer with brakes
MR20DD – CVT	2WD	727 kg Trailer without brakes 1200 kg Trailer with brakes

- 2) The total trailer load must be lower than the following three values, even if it does not exceed the maximum permissible trailer load:

- Towing capacity displayed on a tow-bar.
- Trailer's gross vehicle mass marked on a coupling body.
- Gross vehicle mass marked on a trailer data plate.

The maximum trailer load that can be towed by your vehicle depends on the towing equipment fitted to the vehicle. Therefore, it is important to not only have the correct equipment fitted, but also to use it correctly. Towing loads greater than the value specified for your vehicle or using towing equipment that

is not provided by NISSAN could seriously affect the handling and/or performance of your vehicle.

Vehicle damage resulting from improper towing procedures is not covered by NISSAN warranties. Information on trailer towing and the required equipment should be obtained from a NISSAN dealer or qualified workshop.

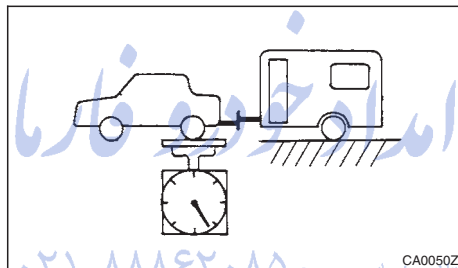

Maximum rear gross axle weight

The rear gross axle weight must not exceed the Gross Axle Weight Rating (GAWR).

Engine – Transmission	Axle	GAWR
R9M – CVT	2WD	1015 kg
MR20DD – 6MT	2WD	985 kg
MR20DD – CVT	2WD	1000 kg

The trailer must be loaded so that heavy goods are placed over the axle.

Maximum tongue load

Never allow the tongue load to exceed 10% of the total trailer load. If the tongue load exceeds 10%, rearrange the cargo in the trailer.

TYRE PRESSURE

When towing a trailer, inflate the vehicle tyres to the maximum recommended COLD tyre pressure, as indicated on the tyre placard (for full loading). Make sure the trailer tyre pressures are correct.

CAUTION

Do not tow a trailer when the vehicle is installed with a temporary-use spare tyre.

SAFETY CHAINS

Always use a suitable chain between the vehicle and trailer. The chain should be attached to the hitch and not to the vehicle bumper or axle. Be sure to leave enough slack in the chain to permit turning corners. The chain should not drag on the ground: passing the chain across the trailer hitch may be the best practice depending on your trailer.

TRAILER BRAKES

Ensure that trailer brakes are installed as required by local regulations. Also check that all other trailer equipment conforms to local regulations.

TRAILER DETECTION (where fitted)

When towing a trailer and the turn signal switch is used, the electrical system of the vehicle will detect an additional electrical load of the trailer lighting. As a result, the trailer direction indicator light comes on.

INSTALLATION OF COUPLING DEVICE (except for Australia)

NISSAN recommends that the coupling device for trailer towing be installed under the following conditions:

- Maximum permissible vertical load on the coupling device: 981 N (100 kg, 221 lb)
- The coupling device, mounting points and installation parts on your vehicle: as shown as an example in the illustration.

Follow all of the coupling device manufacturer's instructions for installation and use.

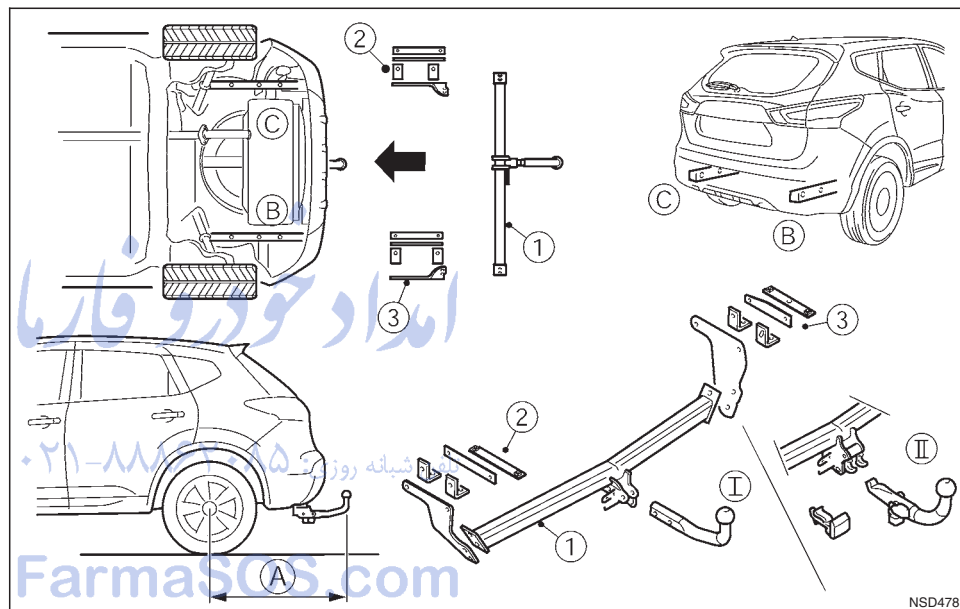

Rear overhang of coupling device:

- Ⓐ 914 mm (36 in)
- Ⓘ Fixed towbar
- Ⓚ Detachable towbar

VEHICLE SECURITY

When leaving your vehicle unoccupied:

- Always remove the ignition key and take it with you – even in your own garage.
- Always remove the ignition key or Intelligent Key (where fitted) and take it with you – even in your own garage.
- Close all windows completely and lock all doors.
- Always park your vehicle where it can be seen. At night, park in a well lit area.
- If the vehicle is equipped with an alarm or immobilization device, use it – even for short periods.
- Do not leave children and pets in the vehicle unattended.
- Do not leave valuables on view to tempt a thief. Always take your valuables with you. If you must leave something in your vehicle, lock it in the luggage compartment or hide it out of sight.
- Do not leave the vehicle documents in your vehicle. In the unfortunate event of your vehicle being stolen, the documents will only help a thief to sell the vehicle.
- Do not leave articles on a roof rack as they are particularly vulnerable. If possible, remove them from the rack and lock them inside the vehicle.
- Do not leave the spare key in the vehicle – keep it in a safe place at home.
- Do not leave the spare key or Intelligent Key in the vehicle – keep it in a safe place at home.

- Do not leave a note of your vehicle's key number in the vehicle. A thief may break into the vehicle, note the key number and return with a new key and drive the vehicle.

امداد خودرو فارما

تلفن شبانه روزی: ۰۲۱-۸۸۸۶۲۰۸۵

FarmaSOS.com

ELECTRIC POWER STEERING SYSTEM



WARNING

- If the engine is not running or is turned off while driving, the power assistance for the steering will not work. The steering will be harder to operate.
- When the electric power steering warning light illuminates with the engine running, the power assistance for the steering will cease operation. You will still have control of the vehicle but the steering will be harder to operate.

The electric power steering system is designed to provide power assistance while driving to allow you to operate the steering wheel with light force.

The steering effort can be set to [Normal] or [Sport] in the vehicle information display under the heading [Driver assistance]. (See "[Driver assistance]" in the "2. Instruments and controls" section.)

NOTE

When the steering wheel is operated repeatedly or continuously while parking or driving at a very low speed, the power assistance for the steering wheel will be reduced. This is to prevent overheating of the electric power steering system and protect it from becoming damaged. While the power assistance is reduced, steering wheel operation will become heavy. When the temperature of the electric power steering system decreases, the power assistance level will return to normal. Avoid repeating such steering wheel operations that could cause the electric power steering system to overheat.

BRAKE SYSTEM

You may hear a sound when the steering wheel is operated quickly. However, this is not a malfunction.

If the electric power steering warning light  illuminates while the engine is running, it may indicate the electric power steering system is not functioning properly and may need servicing. Have the electric power steering system checked by a NISSAN dealer or qualified workshop. (See “ Power steering warning light” in the “2. Instruments and controls” section.)

When the electric power steering warning light illuminates with the engine running, the power assistance for the steering will cease operation. You will still have control of the vehicle. However, greater steering effort is needed, especially in sharp turns and at low speeds.

The brake system has two separate hydraulic circuits. If one circuit malfunctions, two wheels will still have braking ability.

BRAKE PRECAUTIONS

Vacuum assisted brake

The brake booster aids braking by using engine vacuum or vacuum from an engine-driven pump. If the engine stops or the drive belt is broken, you can stop the vehicle by depressing the brake pedal. However, greater foot pressure on the brake pedal will be required to stop the vehicle and the stopping distance will be longer.

Wet brakes

When the vehicle is washed or driven through water, the brakes may get wet. As a result, your braking distance will be longer and the vehicle may pull to one side during braking.

To dry brakes, drive the vehicle at a safe speed while lightly pressing the brake pedal to heat up the brakes. Do this until the brakes return to normal. Avoid driving the vehicle at high speeds until the brakes function correctly.

Using the brakes

Avoid resting your foot on the brake pedal while driving. This will overheat the brakes, wear out the brake linings and pads faster and reduce fuel economy performance.

To help reduce brake wear and to prevent the brakes from overheating, reduce speed and shift to a lower gear before going down a slope or long downhill

gradient. Overheated brakes may reduce braking performance and could result in loss of vehicle control.

CAUTION

While driving on a slippery surface, be careful when braking, accelerating or downshifting. Abrupt braking actions or sudden acceleration could cause the wheels to skid and result in an accident.

Be aware that brakes will fade if repeated heavy brake applications are made.

Driving uphill

When starting on a steep gradient, it is sometimes difficult to operate the brake or both the brake and clutch (MT models). Use the parking brake to hold the vehicle. Do not slip the clutch (MT models). When ready to start, make sure that the shift lever is in an appropriate forward or reverse driving position, slowly release the parking brake while depressing the accelerator pedal and releasing the clutch (MT models) or depressing the accelerator pedal (XTRONIC transmission models). If your vehicle has an electric parking brake, this will automatically release when you depress the accelerator pedal and release the clutch (MT models) or depress the accelerator pedal (XTRONIC transmission models).

ANTI-LOCK BRAKING SYSTEM (ABS)

Driving downhill

The engine braking action is effective for controlling the vehicle while descending hills.

The shift lever (MT models) should be placed in a gear position low enough to obtain sufficient engine braking.

For XTRONIC transmission models, a low gear position in the manual shift mode, low enough to obtain sufficient engine braking, should be selected.



WARNING

- **The Anti-lock Braking System (ABS) is a sophisticated device, but it cannot prevent accidents resulting from careless or dangerous driving techniques. It can help maintain vehicle control during braking on slippery surfaces. Remember that stopping distances on slippery surfaces will be longer than on normal surfaces even with ABS. Stopping distances may also be longer on rough, gravel or snow covered roads, or if you are using snow chains. Always maintain a safe distance from the vehicle in front of you. Ultimately, the driver is responsible for safety.**
- **Tyre type and condition may also affect braking effectiveness.**
 - **When replacing tyres, install the specified size of tyres on all four wheels.**
 - **When installing a spare tyre, make sure that it is the proper size and type as specified on the tyre placard. (See “Vehicle identification” in the “9. Technical information” section.)**
 - **For detailed information, see “Wheels and tyres” in the “8. Maintenance and do-it-yourself” section.**

The Anti-lock Braking System (ABS) controls the brakes so the wheels do not lock during hard braking or when braking on slippery surfaces. The system detects the rotation speed at each wheel and varies the brake fluid pressure to prevent each wheel

from locking and sliding. By preventing each wheel from locking, the system helps the driver maintain steering control and helps to minimise swerving and spinning on slippery surfaces.

USING SYSTEM

Depress the brake pedal and hold it down. Depress the brake pedal with firm steady pressure, but do not pump the brakes. The ABS will operate to prevent the wheels from locking up. Steer the vehicle to avoid obstacles.



WARNING

Do not pump the brake pedal. Doing so may result in increased stopping distances.

SELF-TEST FEATURE

The ABS includes electronic sensors, electric pumps, hydraulic solenoids and a computer. The computer has a built-in diagnostic feature that tests the system each time you start the engine and move the vehicle at a low speed in forward or reverse. When the self-test occurs, you may hear a “clunk” noise and/or feel a pulsation in the brake pedal. This is normal and does not indicate a malfunction. If the computer senses a malfunction, it switches the ABS off and illuminates the ABS warning light on the instrument panel. The brake system then operates normally, but without anti-lock assistance.

If the ABS warning light illuminates during the self-test or while driving, have the vehicle checked by a NISSAN dealer or qualified workshop.





ELECTRONIC STABILITY PROGRAMME (ESP) SYSTEM (where fitted)

NORMAL OPERATION

The ABS operates at speeds above 5 to 10 km/h (3 to 6 MPH). The speed varies according to road conditions.

When the ABS senses that one or more wheels are close to locking up, the actuator rapidly applies and releases hydraulic pressure. This action is similar to pumping the brakes very quickly. You may feel a pulsation in the brake pedal and hear a noise from under the bonnet or feel a vibration from the actuator when it is operating. This is normal and indicates that the ABS is operating properly. However, the pulsation may indicate that road conditions are hazardous and extra care is required while driving.

When accelerating, driving on slippery surfaces or suddenly avoiding obstacles on roads, the vehicle might swerve or slip. The Electronic Stability Programme (ESP) system continuously monitors and compares the driver's intended speed and the travel direction. The system adjusts wheel brake pressure and engine torque to assist in improving vehicle stability.

- When the ESP system is operating, the "SLIP" indicator light () in the combination meter blinks.
- When only the traction control (TCS) system in the ESP system is operating, the "SLIP" indicator light () in the combination meter will also blink.
- If the "SLIP" indicator light () blinks, the road conditions are slippery. Be sure to drive carefully. See "Warning/indicator lights and audible reminders" in the "2. Instruments and controls" section.
- Indicator light
If a malfunction occurs in the system, the "SLIP" indicator light () will come on in the combination meter.

As long as these indicator lights are on, the traction control function is cancelled.

The ESP system uses Active Brake Limited Slip (ABLS) system to improve vehicle traction. The Active Brake Limited Slip (ABLS) system works when one of the driving wheels is spinning on a slippery

surface. The Active Brake Limited Slip (ABLS) system, brakes the spinning wheel to distribute the driving power to the other driving wheel.

If the vehicle is operated with the ESP system turned off, all ESP and TCS functions will be turned off. The Active Brake Limited Slip (ABLS) system and ABS will still operate with the ESP system off. If the Active Brake Limited Slip (ABLS) system is activated, the "SLIP" indicator light () will blink and you may hear a clunk noise and/or feel a pulsation in the brake pedal. This is normal and does not indicate a malfunction.







While the ESP system is operating, you may feel a pulsation in the brake pedal and hear a noise or vibration from under the bonnet. This is normal and indicates that the ESP system is working properly.

The ESP computer has a built in diagnostic feature that tests the system each time the engine is started and the vehicle moves forwards or reverses at a slow speed. When the self-test occurs, you may hear a clunk noise and/or feel a pulsation in the brake pedal. This is normal and is not an indication of a malfunction.



WARNING

- **The ESP system is designed to help improve driving stability but does not prevent accidents caused by abrupt steering operation at high speeds, or careless or dangerous driving techniques. Reduce vehicle speed and be especially careful when driving and cornering on slippery surfaces. Always drive carefully.**

- If engine related parts, such as a muffler, are not standard equipment or are extremely deteriorated, the “SLIP” indicator light () may illuminate.
- If brake related parts, such as brake pads, rotors and callipers, are not standard equipment or are extremely deteriorated, the ESP system may not operate properly and the “SLIP” indicator light () may illuminate.
- Do not modify the vehicle’s suspension. If suspension parts, such as shock absorbers, struts, springs, stabiliser bars and bushings, are not NISSAN-approved or are extremely deteriorated, the ESP system may not operate properly. This could adversely affect vehicle handling performance and the “SLIP” indicator light () may illuminate.
- When driving on extremely inclined surfaces, such as higher banked corners, the ESP system may not operate properly and the “SLIP” indicator light () may illuminate. Do not drive on these types of roads. If ESP OFF indicator light () does illuminate after driving on extreme surfaces, restart the engine to reset the ESP system.
- If wheels or tyres other than the recommended ones are used, the ESP system may not operate properly and the “SLIP” indicator light () may illuminate.
- The ESP system is not a substitute for winter tyres or snow chains on a snow covered road.

NOTE

- The ESP system should be switched on under normal circumstances although it may be advantageous to switch off the ESP system to allow wheelspin under the following conditions:
 - When driving in deep snow or mud.
 - When trying to rock a vehicle free that is stuck in snow.
 - When driving with snow chains.
- If the ESP system has been switched off, drive carefully with reduced speed. When road conditions allow, ESP should be switched back on.

تلفن شبانه روزی: ۰۲۱-۸۸۶۲۰۸۵

FarmaSOS.com

ELECTRONIC STABILITY PROGRAMME (ESP) OFF SWITCH

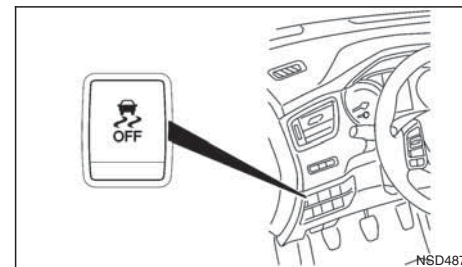

Left hand drive (LHD)

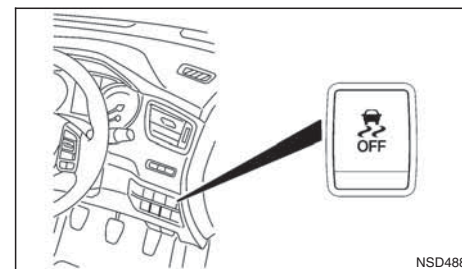

Right hand drive (RHD)

The vehicle should be driven with the Electronic Stability Programme (ESP) system “ON” for most driving conditions.

CHASSIS CONTROL

If the vehicle is stuck in mud or snow, the ESP system reduces the engine output to decrease wheel spin. The engine speed will be reduced even if the accelerator is depressed to the floor. If maximum engine power is needed to free a stuck vehicle, turn the ESP system off.

To turn off the ESP system, push the ESP OFF switch. The ESP OFF indicator light () will come on.

NOTE

The ESP system cannot be switched off when the ESP system is operating and the “SLIP” indicator light () is blinking.

Push the ESP OFF switch again, or restart the engine, to turn the system ON. See “Electronic Stability Programme (ESP) system (where fitted)” earlier in this section for operational details.

The chassis control is an electric control module that includes the following functions:

- Active Trace Control
- Active Engine Brake
- Active Ride Control

ACTIVE TRACE CONTROL



WARNING

The active trace control may not be effective depending on the driving condition. Always drive carefully and attentively.

This system senses driving based on the driver's steering and acceleration/braking patterns, and controls brake pressure at individual wheels to aid tracing at corners and help smooth vehicle response.

The Active trace control system is switched ON (enabled) or OFF (disabled) through the Vehicle Information Display. See “[Driver assistance]” in the “2. Instruments and controls” section for more information.

When the Electronic Stability Programme (ESP) OFF switch is used to turn off the ESP system, the active trace control is also turned off.

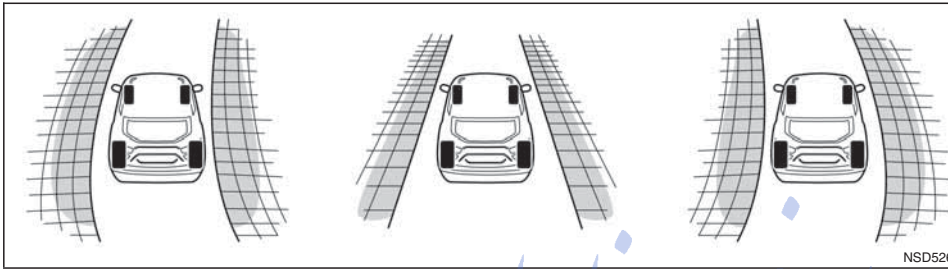

Chassis control

NSD526

When the active trace control is operated and the “Chassis Control” mode is selected in the trip computer, the active trace control graphics are shown in the vehicle information display see “Trip computer” in the “2. Instruments and controls” section for more information.

If the chassis control warning message appears in the vehicle information display, it may indicate that the active trace control is not functioning properly. Have the system checked by a NISSAN dealer or qualified workshop as soon as possible (see also “28. [Chassis control system fault] warning” in the “2. Instruments and controls” section).

When the active trace control is operating, you may feel a pulsation in the brake pedal and hear a noise, this is normal and indicates that the active trace control is operating properly.

Even if the active trace control is set to OFF, some functions will remain on to assist the driver (for example, avoidance scenes).

ACTIVE ENGINE BRAKE (for XTRONIC (CVT) models only)



WARNING

The active engine brake may not be effective depending on the driving condition. Always drive carefully and attentively.

The Active Engine Brake function adds subtle deceleration by controlling gear ratio, depending on the cornering condition calculated from driver's steering input and plural sensors. This benefits easier traceability and less workload of adjusting speed with braking at corners.

The Active Engine Brake also adds subtle deceleration with gear ratio control according to driver's brake pedal operation.

The Active Engine Brake can be set to ON (enabled) or OFF (disabled) through the vehicle infor-

mation display see “28. [Chassis control system fault] warning” in the “2. Instruments and controls” section.

When the active engine brake is operated at corners and the “Chassis Control” mode is selected in the trip computer, the active engine brake graphics are shown in the vehicle information display see “Trip computer” in the “2. Instruments and controls” section for more information.

If the chassis control warning message appears in the vehicle information display, it may indicate that the active engine brake is not functioning properly. Have the system checked by a NISSAN dealer or qualified workshop as soon as possible.

When the active engine brake is operating, the needle of the tachometer will rise up and you may hear an engine noise. This is normal and indicates that the active engine brake is operating properly.

ACTIVE RIDE CONTROL

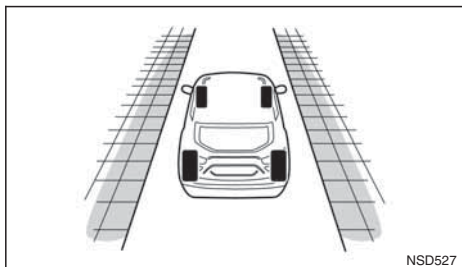

Chassis control

This system senses upper body motion based on wheel speed information and controls engine torque (MR20DD engines only) and four wheel brake pressure to enhance ride comfort in an effort to restrain uncomfortable upper body movement. This system come into effect above 40 km/h (25 MPH).

When the ESP OFF switch is used to turn off the ESP system, the active ride control is also turned off.

When the brake control of active ride control is operated and the "Chassis Control" mode is selected in the trip computer, the active ride control graphics are shown in the vehicle information display see "28. [Chassis control system fault] warning" in the "2. Instruments and controls" section for more information.

If the chassis control warning message appears in the vehicle information display, it may indicate that the active ride control is not functioning properly.

Have the system checked by a NISSAN dealer or qualified workshop as soon as possible.

When the active ride control is operating, you may hear noise and sense slight deceleration. This is normal and indicates that the active ride control is operating properly.

امداد خودرو فارما

تلفن شبانه روزی: ۰۲۱-۸۸۸۶۲۰۸۵

FarmaSOS.com

HILL START ASSIST (HSA) SYSTEM



WARNING

- Never rely solely on the hill start assist system to prevent the vehicle from moving backward on a hill. Always drive carefully and attentively. Depress the brake pedal when the vehicle is stopped on a steep hill. Be especially careful when stopped on a hill on frozen or muddy roads. Failure to prevent the vehicle from rolling backwards may result in a loss of control of the vehicle and possible serious injury or death.
- The hill start assist system is not designed to hold the vehicle at a standstill on a hill. Depress the brake pedal when the vehicle is stopped on a steep hill. Failure to do so may cause the vehicle to roll backwards and may result in a collision or serious personal injury.
- The hill start assist system may not prevent the vehicle from rolling backwards on a hill under all load or road conditions. Always be prepared to depress the brake pedal to prevent the vehicle from rolling backwards. Failure to do so may result in a collision or serious personal injury.

The hill start assist system automatically keeps the brakes applied to help prevent the vehicle from rolling backwards in the time it takes the driver to release the brake pedal and apply the accelerator when the vehicle is stopped on a hill.

The hill start assist system will operate automatically under the following conditions:

- The shift lever is shifted into a forward (vehicle facing uphill) or reverse gear (vehicle facing downhill).
- The vehicle is stopped completely on a hill by applying the foot brake.
- The slope is greater than 3 degrees.

The maximum holding time is 2 seconds. After 2 seconds the vehicle will begin to roll back and the hill start assist system will stop operating completely.

If the slope is steep enough to activate the HSA system, the green HSA indicator light in the combination meter will illuminate.

If the chassis control screen is selected, the vehicle is displayed on a slope. The wheels flash to show that the car is being held.

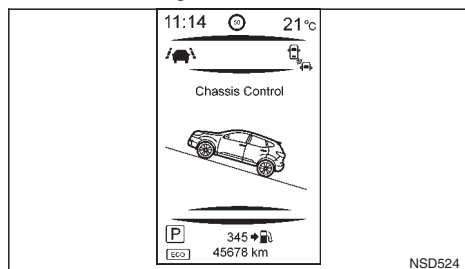

The hill start assist system will not operate when the shift lever is shifted to the N (Neutral) or P (Park) position or on a flat and level road.

When the Electronic Stability Programme (ESP) warning light illuminates in the meter, the hill start assist system will not operate. (See "Electronic Stability Programme (ESP) OFF indicator light (where fitted)" in the "2. Instruments and controls" section.)

امداد خودرو فارما

تلفن شبانه روزی: ۰۲۱-۸۸۸۶۲۰۸۵

FarmaSOS.com

ECO MODE SYSTEM (where fitted)

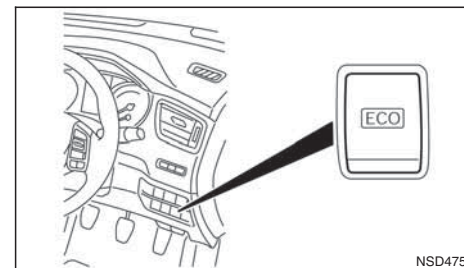

ECO mode switch

The ECO mode system helps to enhance fuel economy by turning on ECO functions within the ECO Meter and modifying engine characteristics to avoid rapid acceleration.

To turn on the ECO mode system, push the ECO mode switch. The ECO mode system indicator light will illuminate on the vehicle information display.

To turn off the ECO mode system, push the ECO mode switch again. The ECO mode system indicator will turn off.

- If the accelerator pedal is fully depressed, the engine characteristics will temporarily return to normal to give maximum available acceleration.
- The ECO mode system will turn off automatically if a malfunction occurs in the system.

COLD WEATHER DRIVING

- Turn off the ECO mode system when acceleration is required, such as when:
 - driving with a heavy load of passengers or cargo in the vehicle
 - driving on a steep uphill slope



WARNING

- **Whatever the conditions, drive with caution. Accelerate and decelerate with great care. If accelerating or decelerating too fast, the drive wheels will lose even more traction.**
- **Allow more stopping distance in cold weather driving. Braking should be started sooner than on dry surfaces.**
- **Keep at a greater distance from the vehicle in front of you on slippery roads.**
- **Wet ice (0°C, 32°F and freezing rain), very cold snow and ice can be slick and very difficult to drive on. The vehicle will have a lot less traction or grip under these conditions. Try to avoid driving on wet ice until the road is salted or sanded.**
- **Watch for slippery spots (black ice). These may appear on an otherwise clear road in shaded areas. If a patch of ice is seen ahead, brake before driving on it. Try not to brake while actually on the ice and avoid any sudden steering manoeuvres.**
- **Do not use cruise control (where fitted) on slippery roads.**
- **Snow can trap dangerous exhaust gas under your vehicle. Keep snow clear of the exhaust pipe and from around your vehicle.**

BATTERY

If the battery is not fully charged during extremely cold weather conditions, the battery fluid may freeze and damage the battery. To maintain maximum efficiency, the battery should be checked regularly. For details, see “Battery” in the “8. Maintenance and do-it-yourself” section.

ENGINE COOLANT

If the vehicle is to be left outside without anti-freeze, drain the cooling system. Refill before operating the vehicle. For details, see “Engine cooling system” in the “8. Maintenance and do-it-yourself” section.

TYRE EQUIPMENT

- 1) The SUMMER tyres are of a tread design to provide superior performance on dry surfaces. However, the performance of these tyres will be substantially reduced in snowy and icy conditions. If you operate your vehicle on snowy or icy roads, NISSAN recommends the use of MUD & SNOW or ALL SEASON tyres on all four wheels. Please consult a NISSAN dealer or qualified workshop for tyre type, size, speed rating and availability information.
- 2) For additional traction on icy roads, studded tyres may be used. However, some countries, provinces and states prohibit their use. Check applicable laws before installing studded tyres.

CAUTION

Skid and traction capabilities of studded snow tyres on wet or dry surfaces may be poorer than that of non-studded snow tyres.

- 3) Snow chains may be used, if desired. But the use of snow chains may be prohibited in some areas. Therefore, check the local laws before installing snow chains. When installing snow chains, make sure they are of proper size for the tyres on your vehicle and are installed according to the snow chain manufacturer's instructions. Use chain tensioners when recommended by the snow chain manufacturer to ensure a tight fit. Loose end links of the snow chain must be secured or removed to prevent the possibility of whipping action damage to the wings or undercarriage. In addition, drive at a reduced speed, otherwise, your vehicle may be damaged and/or vehicle handling and performance may be adversely affected.

SPECIAL WINTER EQUIPMENT

It is recommended to carry the following items in the vehicle during winter:

- A scraper and stiff-bristled brush to remove ice and snow from the windows.
- A sturdy, flat board to be placed under the jack to give it firm support.
- A shovel to dig the vehicle out of snowdrifts.
- Extra windscreen washer fluid to refill the reservoir tank.

CORROSION PROTECTION

Chemicals used for road surface de-icing are extremely corrosive and will accelerate corrosion and the deterioration of underbody components such as the exhaust system, fuel and brake lines, brake cables, floor pan, and wings.

In the winter, the underbody must be cleaned periodically. For additional information, see "Corrosion protection" in the "7. Appearance and care" section.

For additional protection against rust and corrosion, which may be required in some areas, consult a NISSAN dealer or qualified workshop.

تلفن شبانه روزی: ۰۲۱-۸۸۶۲۰۸۵

FarmaSOS.com

NOTE

امداد خودرو فارما

تلفن شبانه روزی: ۰۲۱-۸۸۸۶۲۰۸۵

FarmaSOS.com

6 In case of emergency

Hazard warning flasher switch	6-2	Jump-starting	6-11
Spare tyre.....	6-2	Push-starting	6-13
Temporary-use spare tyre (where fitted)	6-2	Engine overheat.....	6-13
Conventional spare tyre (where fitted)	6-2	Tow truck towing	6-14
Flat tyre	6-3	Towing precautions	6-14
Stopping the vehicle	6-3	Recommended towing for two-wheel drive (2WD) models.....	6-15
Changing flat tyre (Models with spare wheel, where fitted)	6-3	Recommended towing for four-wheel drive (4WD) models.....	6-15
Tyre Pressure Monitoring System (TPMS) (where fitted)	6-7	Towing eye.....	6-16
Repairing flat tyre (Models with emergency tyre puncture repair kit).....	6-8	Freeing the vehicle from sand, snow or mud	6-16

تلفن شبانه روزی: ۰۸۵ ۲۰۸۸۶۲-۲۲

FarmaSOS.com

HAZARD WARNING FLASHER SWITCH

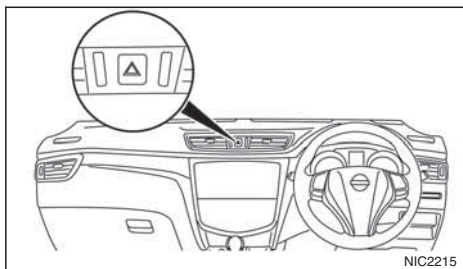

Push the switch on to warn other drivers when you must stop or park under emergency conditions. All direction indicator lights will flash.

SPARE TYRE

TEMPORARY-USE SPARE TYRE (where fitted)



Temporary-use spare tyre label

The temporary-use spare tyre is designed for emergency use only. This spare tyre should be used **ONLY** for very short periods and **NEVER** be used for long drives or extended periods.

Observe the following precautions if the temporary-use spare tyre must be used, otherwise your vehicle could be damaged or involved in an accident.



WARNING

Any continuous road use of this tyre could result in tyre failure, loss of vehicle control, and possible personal injury.

CAUTION

- The temporary-use spare tyre should be used **only** in emergencies. It should be replaced by the standard tyre at the first opportunity.

- Drive carefully and do not drive your vehicle faster than 80 km/h (50 MPH).
- Avoid driving over obstacles. Also, do not take the vehicle through an automatic car wash.
- Avoid driving sharp turns and abrupt braking.
- Do not exceed the vehicle's maximum load rating or the load-carrying capacity molded on the sidewall of the temporary-use spare tyre.
- Do not use a snow chain on this tyre because it will not fit properly. This could cause damage to the vehicle and result in loss of the chain.
- Do not use the temporary-use spare tyre on any other vehicle because this tyre has been designed specifically for your vehicle.
- The vehicle must not be driven with more than one temporary-use spare tyre at the same time.
- Do not tow a trailer.
- As with all tyres, the temporary-use spare tyre must be checked regularly to ensure pressure is maintained.

For pressure details, see the tyre placard located on the driver's side centre pillar.

CONVENTIONAL SPARE TYRE (where fitted)

A standard wheel and tyre is supplied with your vehicle.

FLAT TYRE

In case of a flat tyre, follow the instructions as described below:

STOPPING THE VEHICLE



WARNING

- Make sure that the parking brake is securely applied.
- For Manual Transmission (MT) models: Make sure the shift lever is in the R (Reverse) position.

For XTRONIC models: Make sure that the shift lever is in the P (Park) position.

- Never change tyres when the vehicle is on a slope, ice or a slippery area. This is hazardous.
- Never change tyres if oncoming traffic is close to your vehicle. Wait for professional road assistance.

1. Safely move the vehicle off the road, away from traffic.
2. Switch on the hazard warning flashers.
3. Park on a level surface.
4. Apply the parking brake.
5. Shift the shift lever (MT models) into the R (Reverse) position [XTRONIC models, move the shift lever to the P (Park) position].
6. Turn off the engine.

7. Open the bonnet (for details, see "Bonnet release" in the "3. Pre-driving checks and adjustments" section) in order to:

- Warn other traffic.
- Signal to professional road assistance that you require assistance.

8. Have all passengers exit the vehicle and stand in a safe place, away from traffic and clear of the vehicle.

CHANGING FLAT TYRE (Models with spare wheel, where fitted)

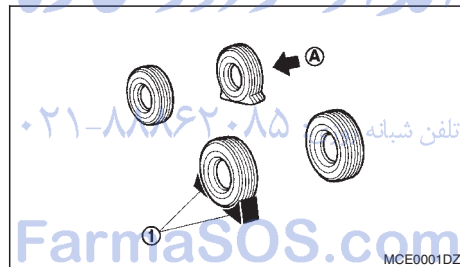

Blocking the wheels



WARNING

Make sure to block the appropriate wheel to prevent the vehicle from moving, which may cause personal injury.

Place suitable blocks (1) in front of and behind the

wheel diagonally opposite the flat tyre (A) to prevent the vehicle from moving when it is on the jack.

Getting the tools and spare wheel

The spare wheel, jack and tools are located inside the luggage compartment.

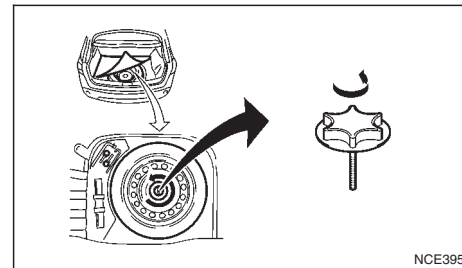

1. Open the back door.
2. Remove the luggage boards and luggage compartment floor cover.
3. Remove the retainer by turning it anticlockwise.
4. Remove the jack, tools and spare wheel.

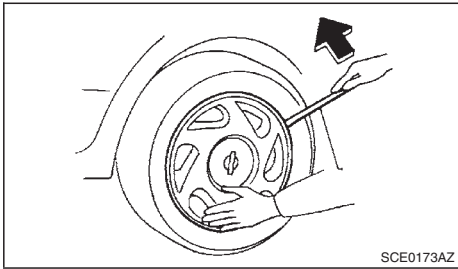

Removing wheel cover (where fitted)



WARNING

Take care when removing the wheel cover as the cover may detach suddenly.

Remove the wheel cover as illustrated with a suitable tool or carefully remove the wheel cover with both hands.

Removing the wheel



WARNING

- Make sure to read the caution label attached to the jack body before use.
- **DO NOT GET UNDER A VEHICLE THAT IS SUPPORTED BY A JACK.**
- Never use a jack which was not provided with your vehicle.

- The jack, which is provided with your vehicle is designed only to lift your vehicle during a tyre change.
- Use the correct jacking points. Never use any other part of the vehicle for jack support.
- Never lift the vehicle more than necessary.
- Never use blocks on or under the jack.
- Do not start or run the engine while the vehicle is on the jack. The vehicle may move suddenly, and this may cause an accident.
- Never allow passengers to stay in the vehicle while the tyre is off the ground.
- Make sure to read the caution label attached to the jack body before use.
- Remove all loads before lifting the vehicle with the jack.

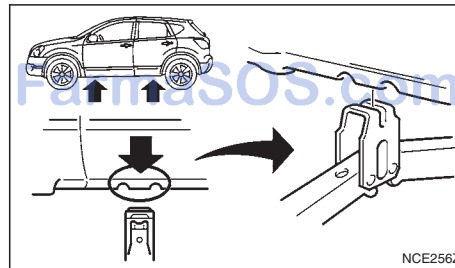

Jack-up points

1. Place the jack directly under the jack-up point as illustrated so that the top of the jack contacts the vehicle at the jack-up point.

CAUTION

The jack should be placed on firm level ground.

2. Align the centre of both the jack head and the notches at the jack-up point as shown.
3. Fit the groove of the jack head between the two notches as shown.

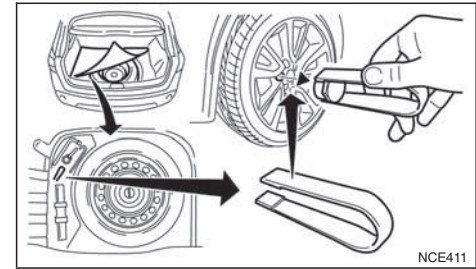

Alloy wheels (where fitted): Alloy wheel bolts have a chrome finish plastic cap that can be removed using tweezers (where fitted) from the tool kit.

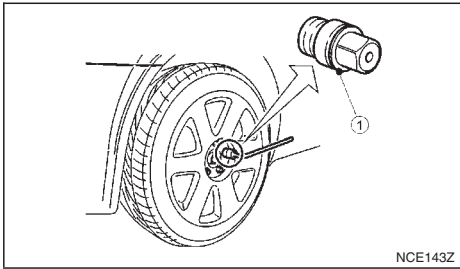

NCE143Z

- Loosen each wheel bolt by one or two turns anticlockwise with the wheel wrench.

Do not remove the wheel bolts until the tyre is off the ground.

Models with wheel lock bolts (where fitted):

If the wheel is equipped with a wheel lock bolt, insert the wheel lock key ① and loosen it as previously described.

The wheel lock bolt can only be removed with the wheel lock key. A key number is necessary if you need to duplicate the wheel lock key.

Record the key number as shown on the key code card on the "Security information" page at the end of this manual and keep it in a safe place, not in the vehicle. If you lose the wheel lock key, see your NISSAN dealer for a duplicate with the original wheel lock key code.

Make sure to keep the lock key in the vehicle. Otherwise, wheels cannot be removed and the service cannot be performed.

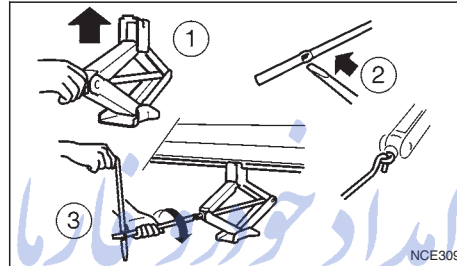

NCE309

- To lift the vehicle, securely hold and turn the handle clockwise as shown.
- Carefully raise the vehicle until the tyre clears the ground.
- Remove the wheel bolts, then remove the wheel with the flat tyre.

CAUTION

The wheel is heavy. Be sure that your feet are clear of the wheel and use gloves as necessary to avoid injury.

Installing the wheel



WARNING

- The temporary use spare tyre (where fitted) is designed for emergency use. See "Spare tyre" earlier in this section.

- Never use wheel bolts other than those provided with your vehicle. Incorrect wheel bolts or improperly tightened wheel bolts may cause the wheel to become loose or come off. This could cause an accident.
- Never use oil or grease on the wheel bolts. This may cause the wheel bolts to become loose.

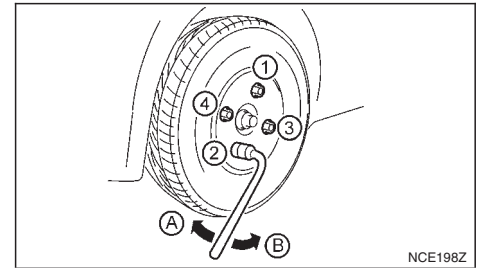

NCE198Z

- (A) Tighten
- (B) Loosen

- Clean any mud or dirt from the surface between the wheel and the hub.
- Carefully fit the wheel and tighten the wheel bolts with your fingers. Check that all the wheel bolts contact the wheel surface horizontally and on the bevelled side.

Models with wheel lock bolt (where fitted):

Insert the wheel lock key into the wheel lock bolt and tighten into the wheel finger tight.

- With the wheel wrench, tighten the wheel bolts alternately and evenly in the sequence as illustrated (① - ⑤) until they are tight.
- Lower the vehicle slowly until the tyre touches the ground.
- Tighten the wheel bolts securely using the wheel wrench in the sequence as illustrated.
- Lower the vehicle completely.
- Install the wheel cover (where fitted).

NOTE

Before installation, align NISSAN logo (centre cap) with the wheel bolts/or perpendicular to valve hole (where fitted), to correctly align to the centre.

Wheel bolt tightening torque:
113 N•m (12 kg-m, 83 ft-lb)

As soon as possible, tighten the wheel bolts to the specified torque with a torque wrench.



WARNING

Retighten the wheel bolts after the vehicle has been driven for 1,000 km (600 miles) (also in cases of a flat tyre, etc.).

The wheel bolts must be kept tightened to specification at all times. It is recommended that the wheel bolts be tightened to specification at each maintenance interval.

Adjust the tyre pressure to the COLD pressure.

COLD pressure is the tyre pressure as measured after the vehicle has been parked for three hours or more or driven for less than 1.6 km (1 mile).

COLD tyre pressures are shown on the tyre placard affixed to the driver's side centre pillar.

Stowing the wheel and tools

Securely store the wheel with the flat tyre, the jack and the tools in the specified storage areas.

Wheel lock bolts (where fitted)

In order to prevent theft, the specially designed wheel lock bolt is installed to each wheel. The wheel lock bolt cannot be removed with the commonly used tools.

When removing tyres, use the lock key provided with your vehicle.

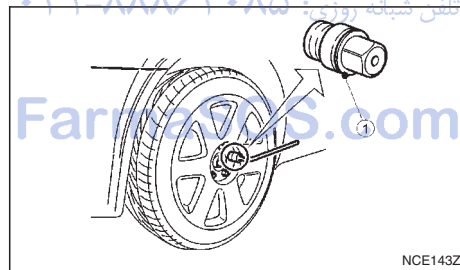

Removing the wheel lock bolt:

- Insert the wheel lock key ① to the wheel lock bolt.
- To remove the wheel lock bolt, turn the wheel lock key anticlockwise using the wheel wrench.

CAUTION

- Do not use a power tool to remove the wheel lock bolts.
- When installing the wheel, tighten the wheel lock bolts to the same tightening torque as the normal wheel bolts. For details, see "Installing the wheel" earlier in this section.

NOTE

- The wheel lock bolt has an individual code. A wheel lock key with other than the individual code cannot remove the wheel lock bolt. If you lose the wheel lock key, contact a NISSAN dealer for a duplicate with the original wheel lock key code.
- Record the key number as shown on the key code card on the "Security information" page at the end of this manual and keep it in a safe place, not in the vehicle.
- When you ask for a service at a NISSAN dealer or qualified workshop, make sure to keep the lock key in the vehicle. Otherwise, wheels cannot be removed and the service cannot be performed.

TYRE PRESSURE MONITORING SYSTEM (TPMS) (where fitted)

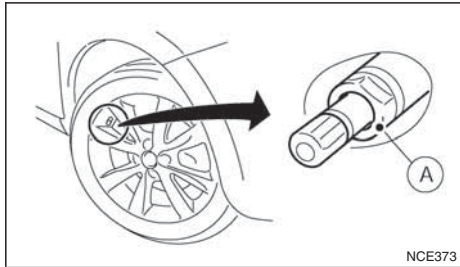

(A) Tyre valve with sensor



WARNING

- If the TPMS indicator light illuminates while driving:
 - avoid sudden steering manoeuvres
 - avoid abrupt braking
 - reduce vehicle speed
 - pull off the road to a safe location
 - stop the vehicle as soon as possible
- Driving with under-inflated tyres may permanently damage the tyres and increase the likelihood of tyre failure. Serious vehicle damage could occur which may lead to an accident and could result in serious personal injury.

- Check the tyre pressure for all four tyres. Adjust the tyre pressure to the recommended COLD tyre pressure shown on the tyre placard to turn the TPMS indicator light “OFF”. In case of a flat tyre, replace it with a spare tyre as soon as possible.
- When a spare tyre is mounted or a wheel is replaced, the TPMS will not function and the TPMS indicator light will flash for approximately 1 minute. The light will remain on after 1 minute. Be sure to follow all instructions for wheel replacement and make sure the TPMS system is mounted correctly.
- Replacing tyres with those not originally specified by NISSAN could affect the proper operation of the TPMS.
- The Genuine NISSAN Emergency Tyre Repair Sealant can be used for temporarily repairing a tyre. Do not inject any other tyre liquid or aerosol tyre sealant into the tyres, as this may cause a malfunction of the tyre pressure sensors.
- NISSAN recommends using only Genuine NISSAN Emergency Tyre Sealant provided with your vehicle. Other tyre sealants may damage the valve stem seal which can cause the tyre to lose air pressure. Visit a NISSAN dealer or qualified workshop as soon as possible after using tyre repair sealant (for models equipped with the emergency tyre puncture repair kit).

CAUTION

- The TPMS may not function properly when the wheels are equipped with tyre chains or the wheels are buried in snow.
- Do not place metalised film or any metal parts (antenna, etc.) on the windows. This may cause poor reception of the signals from the tyre pressure sensors, and the TPMS will not function properly.

Some devices and transmitters may temporarily interfere with the operation of the TPMS and cause the TPMS indicator light to illuminate. Some examples are:

- Facilities or electric devices using similar radio frequencies are near the vehicle.
- If a transmitter set to similar frequencies is being used in or near the vehicle.
- If a computer (or similar equipment) or a DC/AC converter is being used in or near the vehicle.
- When inflating the tyres and checking the tyre pressure, never bend the valves.
- Special aluminium valves are fitted to mount the TPMS sensors on the wheels. The TPMS sensor is fixed at the wheels by a nut. The nut needs to be correctly fitted at a torque setting of 7.5 ± 0.5 Nm. If the TPMS sensor is tightened exceeding the limit, there is a possibility

the sensor grommet will be damaged. If the sensor is tightened under the limit, there is a possibility to cause an air leak.

- Use Genuine NISSAN valve caps that comply with the factory-fitted valve cap specifications.
- Do not use metal valve caps.
- Fit the valve caps properly. Without the valve caps the valve and tyre pressure monitor sensors could be damaged.
- Do not damage the valves and sensors when storing the wheels or fitting different tyres.
- Replace the sensor grommet and washer during a tyre change. Once they have been removed, the sensor grommet and washer cannot be reused and must be replaced. The TPMS sensors can be used again.

The Tyre Pressure Monitoring System (TPMS) monitors the tyre pressure of the four wheels except the spare wheel. When the TPMS indicator light comes on together with the TPMS tyre location indicator light (in the meter panel), one or more of the tyres is significantly under-inflated. If the vehicle is being driven with low tyre pressure, the TPMS will activate and TPMS indicator light together with the TPMS tyre location indicator light remains on. This system will deactivate only when tyre pressure is corrected and the vehicle is driven at speeds above 25 km/h (16 MPH).

For more details about the TPMS, see "Tyre Pressure Monitoring System (TPMS)" in the "5. Starting and driving" section.

6-8 In case of emergency

REPAIRING FLAT TYRE (Models with emergency tyre puncture repair kit)

The emergency tyre puncture repair kit is supplied with the vehicle instead of a spare tyre. This repair kit must be used for temporarily fixing a minor tyre puncture. After using the repair kit, see a NISSAN dealer or qualified workshop as soon as possible for tyre inspection and repair/replacement.

CAUTION

Do not use the emergency tyre puncture repair kit under the following conditions. Contact a NISSAN dealer or qualified workshop or professional road assistance.

- when the sealant has passed its expiration date (shown on the label attached to the bottle)
- when the cut or the puncture is approximately 4 mm (0.16 in) or longer
- when the side of the tyre is damaged
- when the vehicle has been driven with a considerable loss of air from the tyre
- when the tyre is completely displaced inside or outside the rim
- when the tyre rim is damaged
- when two or more tyres are flat

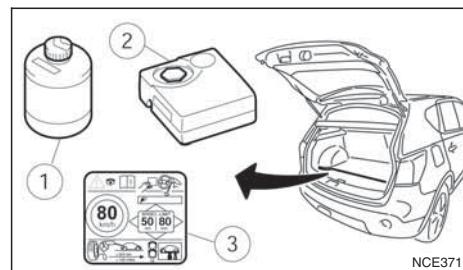

Getting emergency tyre puncture repair kit

Take the emergency tyre puncture repair kit out of the boot. The repair kit consists of the following items:

- ① Tyre sealant bottle
- ② Air compressor
- ③ Speed restriction sticker

NOTE

For models with the emergency tyre puncture repair kit, a spare tyre, jack and rod are not equipped as standard. These parts are dealer options. Contact a NISSAN dealer or qualified workshop about obtaining these parts. See "Removing the wheel" earlier in this section for usage of jacking tools and tyre replacement.

Before using emergency tyre puncture repair kit

- If any foreign object (for example, a screw or nail) is embedded in the tyre, **do not remove it**.
- Check the expiration date of the sealant (shown on the label attached to the bottle). Never use a sealant which has passed its expiration date.



Repairing tyre

1. Shake the sealant bottle well.
2. Remove the bottle cap ③ and the orange plug ② from the top of the compressor.
3. Screw the bottle ④ into the opening of the compressor (where the orange plug was).

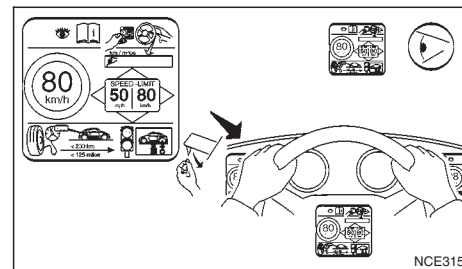

4. Remove the speed restriction sticker from the compressor, then place it in a location where the driver can see it while driving.

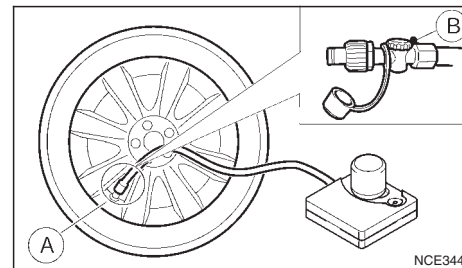

5. Screw the air tube ① of the compressor securely onto the tyre valve. Make sure that the air compressor switch is in the "OFF" (0) position and the pressure release valve ② is securely closed.

6. Insert its power plug into the power outlet in the vehicle. Make sure no other accessories are fitted to the power outlet. For details, see "Power outlet" in the "2. Instruments and controls" section.
7. Turn the ignition switch to the Acc position.
8. Switch on the compressor, and inflate the tyre to the pressure that is specified on the tyre placard affixed to the driver's side centre pillar.

CAUTION

Do not operate the compressor for more than 10 minutes.

If the tyre pressure does not increase to the specified pressure **within 10 minutes**, the tyre may be seriously damaged and **the tyre cannot be repaired with this tyre repair kit**. Contact a NISSAN dealer or qualified workshop.

9. Remove the air compressor from the tyre valve. Immediately drive the vehicle at a speed of 80 km/h (50 MPH) or less.
10. After 10 minute or 10 km (6 miles) drive, check the tyre pressure. The temporary repair is completed if the tyre pressure does not drop.

If the tyre pressure is lower than specified, repeat the steps from step 5.

If the pressure drops again or under 130 kPa (1,3 bar, 19 psi), **the tyre cannot be repaired with this tyre repair kit**. Contact a NISSAN dealer or qualified workshop.

After repairing tyre

See a NISSAN dealer or qualified workshop for tyre repair/replacement, inspection/replacement of the TPMS sensor and for a new tyre sealant bottle and hose, as soon as possible.

امداد خودرو فارما

تلفن شبانه روزی: ۰۲۱-۸۸۸۶۲۰۸۵

FarmaSOS.com

JUMP-STARTING

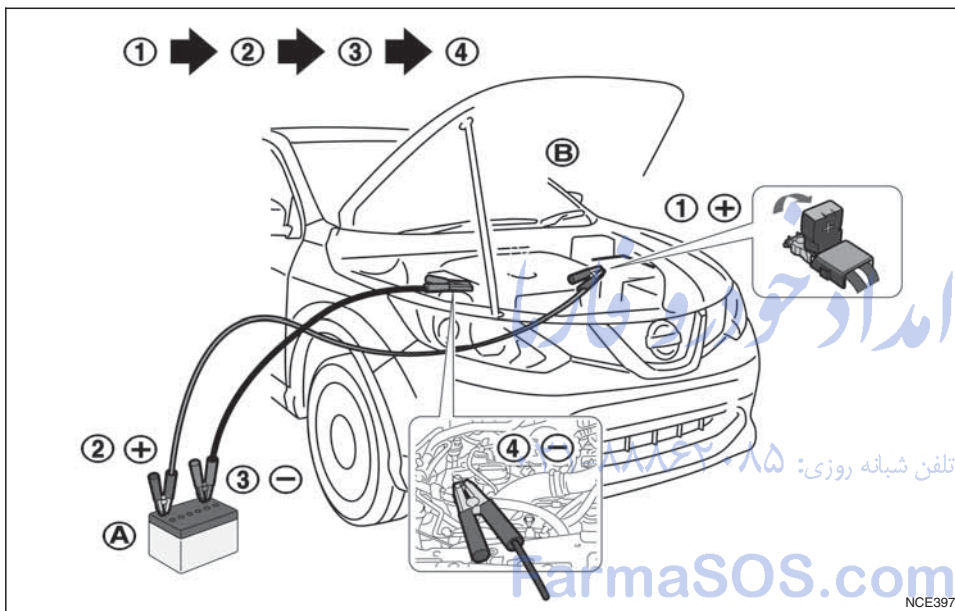

WARNING

- Incorrect jump-starting can lead to a battery explosion. The battery explosion may result in severe injury or death. It may also result in damage to the vehicle. Be sure to follow the instructions in this section.

- Explosive hydrogen gas is always present in the vicinity of the battery. Keep all sparks and flames away from the battery.
- Always wear suitable eye protection glasses and remove rings, bracelets, and any other jewellery whenever working on or near a battery.

- Never lean over the battery while jump-starting.
- Never allow battery fluid to come into contact with eyes, skin, clothes or the vehicle's painted surfaces. Battery fluid is a corrosive sulphuric acid which can cause severe burns. If the fluid comes into contact with anything, immediately flush the contacted area with plenty of water.
- Keep the battery out of the reach of children.
- The booster battery must be rated at 12 volts. Use of an incorrectly rated battery will damage your vehicle.
- Never attempt to jump-start a frozen battery. It could explode and cause serious injury.

1. Check if the parking brake is applied. If not, after connecting the vehicle with the booster battery (after step 8), apply the parking brake. Vehicle has an electric parking brake, for more information see, "Parking brake switch" in the "3. Pre-driving checks and adjustments" section

2. Prepare vehicle (A) with the booster battery for the vehicle (B) being jump-started.

CAUTION

Do not allow the two vehicles to touch.

3. Shift the shift lever (MT models) into the N (Neutral) position [CVT models, move the shift lever to the P (Park) position].

4. Switch off all unnecessary electrical systems (headlights, hazard lights etc.).
5. Ensure that the ignition switch of the vehicle being jump-started is in the LOCK position.
6. Open the bonnet. For details, see "Bonnet release" in the "3. Pre-driving checks and adjustments" section.
7. Remove the vent caps (where fitted) on the battery and cover the battery with an old cloth.
8. Connect the jump leads in the sequence (① → ② → ③ → ④) as illustrated.

CAUTION

- Always connect positive (+) to positive (+) and negative (-) to body ground (for example, engine mount, etc.) – not to the battery's negative (-).
 - An incorrect connection could damage the charging system.
 - Be sure that the jumper cables do not touch moving parts in the engine compartment.
 - Be careful not to allow contact between the positive jump lead connector and the vehicle or the negative lead during connection and disconnection.
9. Start the engine of the other vehicle (A) and let it run for a few minutes. Keep the engine speed at about 2,000 rpm.

10. Start the engine of your vehicle (B) in the normal way.

CAUTION

Do not keep the starter motor engaged for more than 10 seconds. If the engine does not start immediately, turn the ignition switch to "OFF" and wait 10 seconds before trying again.

11. After starting the engine of your vehicle, carefully disconnect the negative lead and then the positive lead (④ → ③ → ② → ①).
12. Remove and dispose of the cloth that was used to cover the vent holes as it may be contaminated with corrosive acid.
13. Install the vent caps (where fitted).
14. Close the bonnet.

NOTE

For models which incorporate the Stop/Start System:

- Ensure that the battery fitted is the special battery that is enhanced with regard to the charge-discharge capacity and life performance. Avoid using any other battery for the Stop/Start System, as this may cause early deterioration of the battery or a malfunction of the Stop/Start System. It is recommended that a Genuine NISSAN battery is fitted. For more information, contact a NISSAN dealer or qualified workshop

- If the battery terminal is disconnected (for battery replacement, etc.) and then reconnected, there may be some delay before the Stop/Start System reactivates.

PUSH-STARTING

CAUTION

- Three-way catalyst equipped models (where fitted) should not be started by pushing the vehicle as the three-way catalyst may be damaged.
- XTRONIC transmission (CVT) models cannot be started by pushing the vehicle. This may cause transmission damage.
- Never try to start the vehicle by towing it; when the engine starts, the forward surge could cause the vehicle to collide with the tow vehicle.

ENGINE OVERHEAT



WARNING

- Never continue driving if the engine of your vehicle overheats. Doing so could cause a vehicle fire.
- Never open the bonnet if steam is coming out.
- Never remove engine coolant reservoir cap when the engine is hot. If the engine coolant reservoir cap is removed while the engine is hot, pressurised hot water will spurt out and possibly cause burning, scalding or serious injury.
- If steam or coolant is coming out of the engine, stand clear of the vehicle to prevent getting injured.
- The engine cooling fan will start whenever the coolant temperature exceeds preset degrees.
- Be careful not to allow your hands, hair, jewellery or clothing to come into contact with, or get caught in, the cooling fan or drive belts.

If the engine of your vehicle is overheating (indicated by the engine coolant temperature gauge) or if you feel a lack of engine power, detect unusual noise, etc., proceed as follows:

1. Move and park the vehicle safely off the road and away from traffic.
2. Turn on the hazard warning flasher lights.
3. Apply the parking brake.

4. Shift the shift lever (MT models) into the N (Neutral) position, XTRONIC transmission (CVT) models: move the shift lever to the P (Park) position.

DO NOT STOP THE ENGINE.

5. Open all windows.
6. Switch off the air conditioner system (where fitted).
7. Set the heater or air conditioner temperature control to maximum "HOT" and fan speed control to maximum speed.
8. Exit the vehicle.
9. Visually inspect and listen for steam or coolant escaping from the radiator before opening the bonnet. Wait until no steam or coolant can be seen before proceeding.
10. Open the bonnet. For details, see "Bonnet release" in the "3. Pre-driving checks and adjustments" section.
11. Visually check if the cooling fan is running.
12. Visually check the radiator and radiator hoses for leakage.



WARNING

If coolant is leaking, the cooling fan belt is missing or loose or the cooling fan is not running, stop the engine.

TOW TRUCK TOWING

13. After the engine cools down, check the coolant level in the engine coolant reservoir with the engine running.
14. If the level is low, remove the engine coolant reservoir cap and add coolant slowly into the reservoir. After refilling the reservoir to the MAX level, install the reservoir cap.



WARNING

Before removing the engine coolant reservoir cap and to avoid the danger of being scalded, cover the reservoir cap with a rag and loosen the reservoir cap to the first notch to allow the steam to escape.

15. Close the bonnet.

Have your vehicle inspected or repaired by a NISSAN dealer or qualified workshop.

When towing your vehicle, local regulations for towing must be followed. Incorrect towing equipment could damage your vehicle. To assure proper towing and to prevent accidental damage to your vehicle, NISSAN recommends that you have a service operator tow your vehicle. It is advisable to have the service operator carefully read the following precautions.



WARNING

- Do not allow any occupants in the vehicle that is being towed.
- Never get under your vehicle after it has been lifted by a tow truck.

TOWING PRECAUTIONS

- **When towing:** Make sure that the transmission, axles, steering system and power train are in working condition. If any unit is damaged, the vehicle must be towed using a dolly or be placed on a flat bed lorry.
- Release the parking brake and shift the manual transmission (MT) or XTRONIC transmission (CVT) into the N (Neutral) position before starting to tow the vehicle.
- Always attach safety chains before towing.

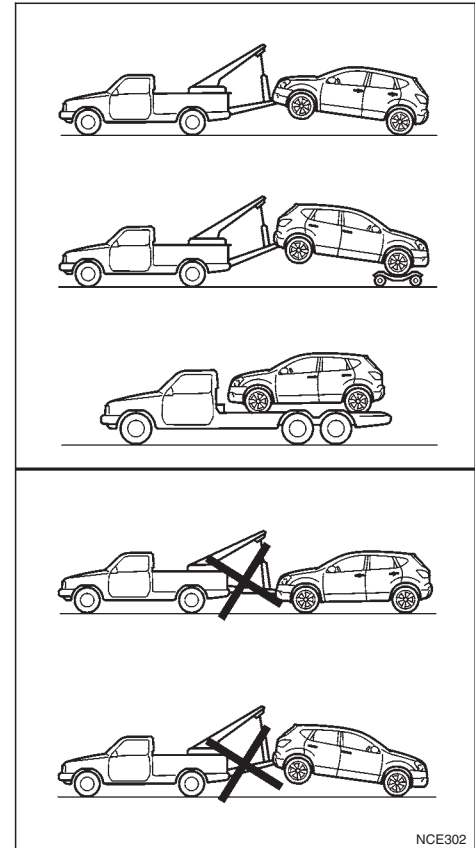

NCE302

2WD models

RECOMMENDED TOWING FOR TWO-WHEEL DRIVE (2WD) MODELS

CAUTION

NEVER tow XTRONIC transmission (CVT) models with the front wheels on the ground or with all four wheels on the ground (forwards or backwards), this may cause serious and expensive damage to the transmission. If it is necessary to tow the vehicle with the rear wheels raised, always use towing dollies under the front wheels.

NISSAN recommends that your vehicle should be towed with the driving (front) wheels off the ground or that the vehicle be placed on a flat bed lorry as illustrated.

When towing with the front wheels – on the ground (MT models only) or – on towing dollies:

Turn the ignition switch to the "OFF" position, then secure the steering wheel in a straight ahead position using a rope or similar device. **Never place the ignition switch in the LOCK position.** This will result in damage to the steering lock mechanism.

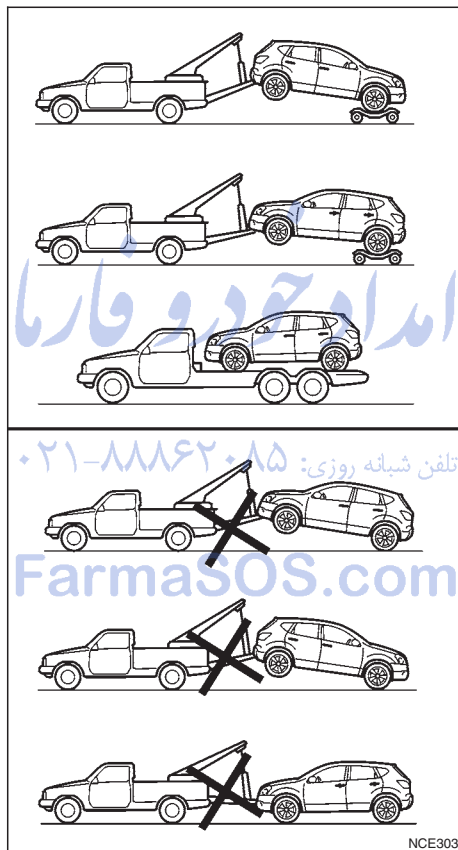

4WD models

RECOMMENDED TOWING FOR FOUR-WHEEL DRIVE (4WD) MODELS

CAUTION

NEVER tow the vehicle with any wheels on the ground as this may cause serious and expensive damage to the transmission.

NISSAN recommends that towing dollies be used when towing your vehicle or that the vehicle be placed on a flat bed lorry as illustrated.

When towing with the front wheels on towing dollies:

Turn the ignition switch to the "OFF" position, then secure the steering wheel in a straight ahead position using a rope or similar device. **Never place the ignition switch in the LOCK position.** This will result in damage to the steering lock mechanism.

TOWING EYE

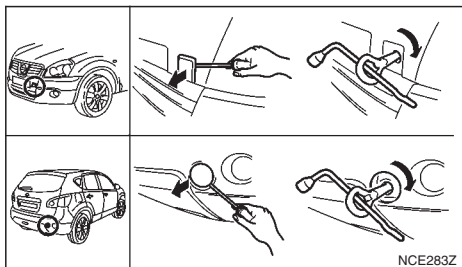

The towing eye is stored with the vehicle tools and located in the spare wheel recess (luggage compartment area).

- 1) Remove the cover from the bumper.
- 2) Securely install the towing eye, as illustrated.

Make sure that the towing eye is properly stored in its designated location after use.

FREEING THE VEHICLE FROM SAND, SNOW OR MUD



WARNING

- Never allow anyone to stand near the towing line during the pulling operation.
- Never spin the tyres at high speed. This could cause them to explode and result in serious injury. Parts of the vehicle could also overheat and be damaged.

Towing eye usage

The towing eye should be used in the event that your vehicle becomes trapped in sand, snow or mud, and is unable to drive away without being pulled, use the towing eye.

- Use the towing eye **only**, not other parts of the vehicle. Otherwise, the vehicle body will be damaged.
- **Only** use the towing eye to free a vehicle stuck in sand, snow, mud, etc.
- Never tow the vehicle for a long distance using only the towing eye.
- The towing eye is under tremendous force when used to free a stuck vehicle. Always pull the cable straight out from the front of the vehicle. Never pull on the towing eye at a sideways angle.

CAUTION

In order not to break the towing line, tension it slowly.

7 Appearance and care

Cleaning exterior.....	7-2	Air fresheners	7-4
Washing.....	7-2	Floor mats	7-4
Removing spots.....	7-2	Cleaning Glass.....	7-5
Waxing	7-2	Plastic parts.....	7-5
Cleaning glass.....	7-3	Seat belts	7-5
Cleaning rear-view camera (where fitted).....	7-3	Corrosion protection.....	7-5
Underbody	7-3	Most common factors contributing to vehicle	
Care of wheels	7-3	corrosion	7-5
Cleaning alloy wheels	7-3	Environmental factors influence the rate of	
Chrome parts	7-3	corrosion	7-5
Cleaning interior	7-4	To protect your vehicle from corrosion	7-6
Monitor display's maintenance (where fitted).....	7-4		

تلفن شبانه روزی: ۰۸۵ ۲۸۸۶۲۰۴۱
FarmaSOS.com

CLEANING EXTERIOR

In order to maintain the appearance of your vehicle, it is important to take proper care of it.

Whenever possible, park your vehicle inside a garage or in a covered area to minimise the chances of damaging the paint surface of your vehicle.

When it is necessary to park outside, park in a shady area or protect the vehicle with a body cover. **Be careful not to scratch the paint surface when putting on or removing the body cover.**

WASHING

In the following instances, wash your vehicle as soon as possible to protect the paint surface:

- After a rainfall, to prevent possible damage from acid rain.
 - After driving on coastal roads.
 - When contaminants such as soot, bird droppings, tree sap, metal particles or insects get on the paint surface.
 - When dust or mud builds up on the paint surface.
1. Wash the vehicle surface with a wet sponge and plenty of water.
 2. Clean the vehicle surface gently and thoroughly using a mild soap or a special vehicle wash shampoo mixed with clean, lukewarm (never hot) water.

CAUTION

- **Do not wash the vehicle with strong household soap, strong chemical detergents, petrol or solvents.**
- **Do not wash the vehicle in direct sunlight or while the vehicle body is hot, as the paint surface may become water-spotted.**
- **Avoid using tight-napped or rough cloths, such as washing mitts. Care must be taken when removing caked-on dirt or other foreign substances so the paint surface is not scratched or damaged.**

3. Rinse the vehicle thoroughly with plenty of clean water.

4. Use a damp chamois to dry the paint surface to avoid leaving water spots.

When washing the vehicle, take care of the following:

- Inside flanges, joints and folds on the doors, back door and bonnet are particularly vulnerable to the effects of road salt. Therefore, these areas must be cleaned regularly.
- Be sure that the drain holes in the lower edge of the doors are not clogged.
- Spray water to the underbody and in the wheel wells to loosen the dirt and/or wash away road salt.

- If using a high pressure washer always follow the recommendations on the equipment (pressure and spraying distance).

CAUTION

Do not spray directly into the engine compartment with a high-pressure washer/hose this could damage the engine.

- If there are damaged areas on the vehicle (e.g. painted bumpers or headlamp assembly), it is not recommended to direct the high pressure jet on to them. Carefully wash these areas by hand.
- Avoid the entry of water into the locks.

REMOVING SPOTS

Remove tar and oil spots, industrial dust, insects, and tree sap as quickly as possible from the paint surface to avoid lasting damage or staining. Special cleaning products are available at a NISSAN dealer or any automotive accessory store.

WAXING

Regular waxing protects the paint surface and helps to retain a new vehicle appearance.

After waxing, polishing is recommended to remove built-up residue.

A NISSAN dealer or qualified workshop can assist you in choosing the appropriate waxing products.

CAUTION

- **Wash your vehicle thoroughly and completely before applying wax to the paint surface.**

- Always follow the manufacturer's instructions supplied with the wax.
- Do not use a wax containing any abrasives, cutting compounds or cleaners that may damage the vehicle finish.
- If the vehicle surface cannot polish easily, apply a road tar remover prior to waxing the vehicle.
- Machine compounding or aggressive polishing on a base coat/clear coat paint finish may dull the finish or leave swirl marks.

CLEANING GLASS

Use glass cleaner to remove smoke and dust film from the glass surfaces. It is normal for glass to become coated with a film after the vehicle is parked in the hot sun. Glass cleaner and a soft cloth will easily remove this film.

CLEANING REAR-VIEW CAMERA (where fitted)

Clean the transparent camera cover regularly. If dirt, rain or snow attaches to the cover, the monitor may not display objects clearly.

CAUTION

- Do not use alcohol, benzine or thinner to clean the transparent camera cover. This will cause discoloration. To clean the cover, first use a cloth dampened with diluted mild cleaning agent and then wipe with a dry cloth.

- Do not use body wax on the transparent camera cover.
- When washing the vehicle with a high pressure water spray, make sure not to spray it around the transparent camera cover. Otherwise, water may enter the camera unit causing water condensation on the lens and it may result in a malfunction or an electric shock.

UNDERBODY

In areas where road salt is used in the winter, the vehicle's underbody must be cleaned regularly. This will prevent dirt and salt from building up and causing underbody and suspension corrosion.

Before the winter period and again in the spring, the underseal must be checked and, if necessary, re-treated.

CARE OF WHEELS

- Wash the wheels when washing the vehicle to maintain their appearance.
- Clean the inner side of the wheels when the wheel is changed or the underside of the vehicle is washed.
- Do not use abrasive cleaners when washing the wheels.
- Inspect wheel rims regularly for dents or corrosion. This may cause loss of pressure or damage the tyre bead.

- NISSAN recommends that the road wheels be waxed to protect against road salt in areas where it is used during winter.

CLEANING ALLOY WHEELS

Wash the wheels regularly with a sponge dampened in a mild soap solution, especially during winter in areas where road salt is used. The salt residue from road salt could discolour the wheels if it is not washed off regularly.

CAUTION

Follow the directions as described below in order to avoid staining or discolouring of the wheels.

- Do not use a cleaner that contains strong contents of acid or alkali to clean the wheels.
- Do not apply wheel cleaner when the wheels are hot. The wheel temperature should be the same as ambient temperature.
- Rinse the wheel to completely remove the cleaner within 15 minutes after the cleaner has been applied.

CHROME PARTS

Clean all chrome parts regularly with a nonabrasive chrome polish to maintain the finish.

CLEANING INTERIOR

Occasionally remove loose dust from the interior trim, plastic parts and seats using a vacuum cleaner or soft bristled brush. Wipe the vinyl and leather surfaces with a clean, soft cloth dampened in mild soap solution, then wipe clean with a dry, soft cloth.

Regular care and cleaning is required in order to maintain the appearance of the leather.

Before using any fabric protector, read the manufacturer's recommendations. Some fabric protectors contain chemicals that may stain or bleach the seat material.

Use a soft cloth dampened only with water to clean the meter and gauge lens covers.

CAUTION

- **Never use benzine, thinner or any similar material.**
- **Small dirt particles can be abrasive and damaging to leather surfaces and should be removed promptly. Do not use saddle soap, car waxes, polishes, oils cleaning fluids, solvents, detergents or ammonia based cleaners as they may damage the leather's natural finish.**
- **Never use fabric protectors unless recommended by the manufacturer.**
- **Do not use glass or plastic cleaner on meter or gauge lens covers. It may damage the lens covers.**

MONITOR DISPLAY'S MAINTENANCE (where fitted)

- To clean the display screen, first turn the ignition off and wipe it with a dry soft cloth.
- Never use a rough cloth, alcohol, benzene, thinner, any kind of solvent, or paper tissues with chemical cleaning agent. They would scratch or deteriorate the panel.
- Do not splash any liquid such as water or car fragrance on the display. Contact with liquid will cause the system to malfunction and damage the hardware.
- In case of extreme stain, use a small amount of neutral detergent with a soft cloth. Never soak the screen display with water detergent.

AIR FRESHENERS تلفن شبانه روزی: ۸۵

Most air fresheners use a solvent that could affect the vehicle interior. If you use an air freshener, take the following precautions:

- Hanging-type air fresheners can cause permanent discoloration when they contact vehicle interior surfaces. Place the air freshener in a location that allows it to hang free and not contact an interior surface.
- Liquid-type air fresheners typically clip on the vents. These products can cause immediate damage and discoloration when spilled on interior surfaces.

Carefully read and follow the manufacturer's instructions before using air fresheners.

FLOOR MATS

The use of NISSAN floor mats can extend the life of your vehicle carpet and make it easier to clean the interior. Regardless of what mats are used, be sure they are fitted for your vehicle and are properly positioned in the foot well to prevent interference with pedal operation. Mats should be maintained with regular cleaning and replaced if they become excessively worn.

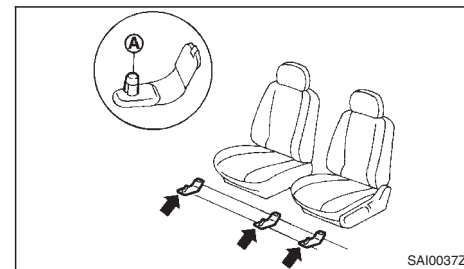

Floor mat positioning aid

Note that the above illustration is for LHD models.

This vehicle includes front floor mat brackets (A) to act as a floor mat positioning aid. NISSAN floor mats have been specially designed for your vehicle.

Position the mat by placing the floor mat bracket hook through the floor mat grommet hole while centering the mat in the foot area.

Periodically check that the mats are properly positioned.

CLEANING GLASS

Use glass cleaner to remove smoke and dust film from the glass surfaces. It is normal for glass to become coated with a film after the vehicle is parked in the hot sun. Glass cleaner and a soft cloth will easily remove this film.

CAUTION

When cleaning the inside of the windows, do not use sharp-edged tools, abrasive cleaners or chlorine-based disinfectant cleaners. They could damage elements in the rear windows (such as the window defogger).

Inside rear-view mirror (Automatic anti-dazzling, where fitted)

Use a soft cloth dampened only with water to clean the automatic anti-dazzling inside rear view mirror (where fitted).

CAUTION

Do not use glass cleaner. Doing so will reduce the sensitivity of the sensor, resulting in improper operation.

PLASTIC PARTS

Plastic parts can be cleaned with a mild soap solution. If the dirt cannot be easily removed, use a plastic cleaner. Do not use any solvents.

SEAT BELTS



WARNING

- **Do not allow wet seat belts to roll up in the retractor.**
- **Never use bleach, dye or chemical solvents to clean the seat belts, since these materials may severely weaken the seat belt webbing.**

The seat belts can be cleaned by wiping them with a sponge dampened in a mild soap solution.

Allow the belts to dry completely in the shade before using them.

تلفن شبانه روزی: ۰۲۱-۸۸۶۲۰۸۵

FarmaSOS.com

CORROSION PROTECTION

MOST COMMON FACTORS CONTRIBUTING TO VEHICLE CORROSION

- The accumulation of moisture-retaining dirt and debris in body panel sections, cavities, and other areas.
- Damage to the paint surface and other protective coatings caused by gravel and stone chips or minor traffic accidents.

ENVIRONMENTAL FACTORS INFLUENCE THE RATE OF CORROSION

Moisture

Accumulation of sand, dirt and water on the vehicle body underside can accelerate corrosion. Wet floor coverings will not dry completely inside the vehicle, and should be removed for drying to avoid floor panels corrosion.

Relative humidity

Corrosion will be accelerated in areas of high relative humidity, especially those areas where the temperatures stay above freezing, where atmospheric pollution exists and road salt is used.

Temperature

A temperature increase will accelerate the rate of corrosion to those parts which are not well ventilated.

Corrosion will also accelerate in areas where the temperatures stay above freezing.

Air pollution

Industrial pollution, the presence of salt in the air in coastal areas, or heavy road salt use will accelerate the corrosion process. Road salt will also accelerate the disintegration of paint surfaces.

TO PROTECT YOUR VEHICLE FROM CORROSION

- Wash and wax your vehicle often to keep the vehicle clean.
- Always check for minor damage to the paint surface and if any exists, repair it as soon as possible.
- Keep the drain holes at the bottom of the doors and back door opened to avoid water accumulation.
- Check the vehicle underbody for accumulation of sand, dirt or salt. If present, wash with water as soon as possible.

CAUTION

- **Never remove dirt, sand or other debris from the passenger compartment by washing it out with a hose. Remove dirt with a vacuum cleaner or broom.**
- **Never allow water or other liquids to come in contact with electronic components inside the vehicle as this may damage them.**

Chemicals used for road surface de-icing are ex-

tremely corrosive. They accelerate corrosion and deterioration of underbody components such as the exhaust system, fuel and brake lines, brake cables, floor pan and fenders.

In the winter, the underbody must be cleaned periodically.

For additional protection against rust and corrosion, which may be required in some areas, consult a NISSAN dealer or qualified workshop.

امداد خودرو فارما

تلفن شبانه روزی: ۰۲۱-۸۸۸۶۲۰۸۵

FarmaSOS.com

NOTE

امداد خودرو فارما

تلفن شبانه روزی: ۰۲۱-۸۸۸۶۲۰۸۵

FarmaSOS.com

8 Maintenance and do-it-yourself

Maintenance requirements	8-2	Jump-starting	8-18
Scheduled maintenance	8-2	Integrated keyfob/Intelligent Key battery replacement	8-18
General maintenance	8-2	Drive belts	8-20
Where to go for service	8-2	Spark plugs (Petrol engine models)	8-21
General maintenance	8-2	Air duct removal	8-21
Explanation of general maintenance items	8-2	Air cleaner filter	8-23
Maintenance precautions	8-4	Viscous paper type	8-23
Engine compartment	8-5	Dry paper type (where fitted)	8-23
Engine cooling system	8-6	Wiper blades	8-24
Checking engine coolant level	8-6	Cleaning	8-24
Changing engine coolant	8-6	Front window wiper replacement	8-24
Engine oil	8-8	Back door window wiper replacement	8-24
Checking engine oil level	8-8	Windscreen washer nozzle	8-25
Changing engine oil	8-9	Fuses	8-25
Changing engine oil filter	8-10	Passenger compartment	8-25
Protect the environment	8-12	Engine compartment	8-26
Fuel filter (Diesel engine models)	8-13	Lights	8-27
Draining water	8-13	Headlights	8-28
Bleeding the fuel system	8-13	Exterior lights	8-29
XTRONIC Continuously variable transmission (CVT) fluid	8-13	Interior lights	8-29
Brakes	8-13	Light locations	8-30
Checking parking brake	8-13	Wheels and tyres	8-33
Checking brake pedal	8-13	Tyre inflation pressure	8-33
Brake booster	8-14	Types of tyres	8-33
Brake and clutch fluid	8-14	Snow chains	8-34
Window washer fluid/headlight cleaner fluid (where fitted)	8-15	Tyre rotation	8-34
Battery	8-16	Tyre wear and damage	8-35
Vehicle battery	8-16	Tyre age	8-35
		Changing tyres and wheels	8-35

Four-wheel drive (4WD) models	8-35
Wheel balance.....	8-36
Spare tyre	8-36
Care of wheels	8-36

امداد خودرو فارما

تلفن شبانه روزی: ۰۲۱-۸۸۸۶۲۰۸۵

FarmaSOS.com

MAINTENANCE REQUIREMENTS

Some day-to-day and regular maintenance is essential to maintain your NISSAN's good mechanical condition, as well as its emission and engine performance.

It is the owner's responsibility to make sure that the specified maintenance, as well as general maintenance, is performed.

As the vehicle owner, you are the only one who can ensure that your vehicle receives the proper maintenance care.

SCHEDULED MAINTENANCE

For your convenience, the required scheduled maintenance items are described and listed in the separate Warranty Information and Maintenance booklet. You must refer to that booklet to ensure that necessary maintenance is performed on your NISSAN vehicle at regular intervals.

GENERAL MAINTENANCE

General maintenance includes those items which should be checked during normal day-to-day operation of the vehicle. They are essential if your vehicle is to continue to operate properly. It is your responsibility to perform these procedures regularly as prescribed.

Performing general maintenance checks requires minimal mechanical skill and a few general automotive tools.

These checks or inspections can be done by yourself, a qualified technician or, if you prefer, your NISSAN dealer or qualified workshop.

WHERE TO GO FOR SERVICE

If maintenance service is required or your vehicle appears to malfunction, have the systems checked and tuned by an authorised NISSAN dealer or qualified workshop.

امداد خودرو فارما

تلفن شبانه روزی: ۰۲۱-۸۸۸۶۲۰۸۵

FarmaSOS.com

GENERAL MAINTENANCE

During the normal day-to-day operation of the vehicle, general maintenance should be performed regularly as prescribed in this section. If you detect any unusual sounds, vibrations or smell, be sure to check for the cause or have a NISSAN dealer or qualified workshop do it promptly. In addition, you should notify a NISSAN dealer or qualified workshop if repairs are required.

When performing any checks or maintenance work, closely observe the "Maintenance precautions" later in this section.

EXPLANATION OF GENERAL MAINTENANCE ITEMS

Additional information on the following items with an asterisk (*) is found later in this section.

The maintenance items listed here should be performed from time to time, unless otherwise specified.

Outside the vehicle

Back door, doors and bonnet:

Check that the back door, all doors and the bonnet operate properly. Also ensure that all latches lock securely. Lubricate hinges and latches if necessary. Make sure that the secondary latch keeps the bonnet from opening when the primary latch is released.

When driving in areas using road salt or other corrosive materials, check for lubrication frequently.

Lights*:

Clean the headlights on a regular basis. Make sure that the headlights, stop lights, tail lights, turn signal lights, and other lights are all operating properly and installed securely. Also check headlight aim.

Tyres*:

Check the pressure with a gauge periodically when at a service station (including the spare) and adjust to the specified pressure if necessary. Check carefully for damage, cuts or excessive wear.

Tyre rotation*:

Tyres should be rotated every 10,000 km (6,000 miles) for Two-Wheel Drive (2WD) models and 5,000 km (3,000 miles) for Four-Wheel Drive (4WD) models. However, the timing for tyre rotation may vary according to your driving habits and road surface conditions.

Tyre Pressure Monitoring System (TPMS) transmitter components (where fitted):

Replace the TPMS transmitter grommet seal, valve core and cap when the tyres are replaced due to wear or age.

Wheel alignment and balance:

If the vehicle pull to either side while driving on a straight and level road, or if you detect uneven or abnormal tyre wear, there may be a need for wheel alignment. If the steering wheel or seat vibrates at normal highway speeds, wheel balancing may be needed.

Wheel nuts:

When checking the tyres, make sure no wheel nuts are missing, and check for any loose wheel nuts. Tighten if necessary.

Windscreen:

Clean the windscreen on a regular basis. Check the windscreen at least every six months for cracks or other damage. Have a damaged windscreen repaired by a qualified repair facility.

Wiper blades*:

Check for cracks or wear if they do not wipe properly.

Under the bonnet and vehicle

The maintenance items listed here should be checked periodically, e.g. each time you check the engine oil or refuel.

Battery*:

Check if the green indicator on the top of the maintenance free battery is visible. If it is not visible, replace the battery as soon as possible.

Vehicles operated in high temperatures or under severe conditions, check the fluid level frequently.

Brake and clutch fluid level*:

Make sure that the brake and clutch fluid level is between the MAX and MIN lines on the reservoir.

Engine coolant level*:

Check the coolant level when the engine is cold.

Engine drive belts*:

Make sure that the drive belts are not frayed, worn, cracked or oily.

Engine oil level*:

Check the level after parking the vehicle on a level surface and turning off the engine.

Fluid leaks:

Check under the vehicle for fuel, oil, water or other fluid leaks after the vehicle has been parked for a while. Water dripping from the air conditioner after use is normal. If you should notice any leaks or if petrol fumes are evident, check for the cause and have it corrected immediately.

Window washer fluid*:

Check that there is adequate fluid in the tank.

Inside the vehicle

The maintenance items listed here should be checked on a regular basis, such as when performing periodic maintenance, cleaning the vehicle, etc.

Accelerator pedal:

Check the pedal for smooth operation and make sure that the pedal does not catch or require uneven effort. Keep the floor mats away from the pedal.

Brake pedal*:

Check the pedal for smooth operation. If the brake pedal suddenly goes down further than normal, the pedal feels spongy or the vehicle seems to take

MAINTENANCE PRECAUTIONS

longer to stop, contact a NISSAN dealer or qualified workshop immediately. Keep the floor mat away from the pedal.

Parking brake*:

Confirm that your vehicle is held securely on a fairly steep hill with only the parking brake applied.

Seats:

Check seat position controls such as seat adjusters, seatback recliner, etc. to ensure they operate smoothly and all latches lock securely in every position. Check that the head restraints move up and down smoothly and the locks hold securely in all latched positions.

Seat belts:

Check that all parts of the seat belt system (e.g. buckles, anchors, adjusters and retractors) operate properly and smoothly, and are installed securely. Check the belt webbing for cuts, fraying, wear or damage. See "Seat belts" in the "1. Safety — Seats, Seat belts and Supplemental Restraint System" section for further details.

Steering wheel:

Check for any change in the steering conditions, such as excessive free play, hard steering or strange noises.

Warning lights and audible reminders:

Make sure that all warning/indicator lights and audible reminders are operating properly.

Windscreen defogger:

Check that the air comes out of the defogger outlets properly when operating the heater or air conditioner.

Windscreen wiper and washer*:

Check that the wipers and washer operate properly and that the wipers do not streak.

امداد خودرو فارما

تلفن شبانه روزی: ۰۲۱-۸۸۸۶۲۰۸۵

FarmaSOS.com

When performing any inspection or maintenance work on your vehicle, always take care to prevent serious accidental injury to yourself or damage to the vehicle. The following are general precautions which should be closely observed.

- **Park the vehicle on a level surface, apply the parking brake securely and block the wheels to prevent the vehicle from moving. For manual transmission models, move the shift lever to N (Neutral) position. For continuously variable transmission models: move the shift lever to P (Park) position.**
- **Do not work under the engine bonnet while the engine is hot. Turn off the engine and wait until it cools down.**
- **Be sure to turn the ignition switch to the "OFF" or LOCK position.**

When the ignition switch is in the ON or ACC position, the cooling fan may start to operate suddenly even when the engine is not running. To avoid injury, always disconnect the negative battery cable before working near the engine.

- **If you must work with the engine running, keep your hands, clothing, hair and tools away from moving fans, belts and any other moving parts.**
- **It is advisable to remove ties and any jewellery, such as rings, watches, etc. before working on your vehicle.**

ENGINE COMPARTMENT

- If you must run the engine in an enclosed space such as a garage, be sure there is proper ventilation for exhaust gases.
- **DO NOT GET UNDER A VEHICLE THAT IS SUPPORTED BY A JACK.**
- Keep smoking materials, flame and sparks away from fuel and battery.
- Never connect or disconnect either the battery or any transistorised component connector while the ignition switch is in the ON position.
- Never leave the engine or transmission related component harness connector disconnected while the ignition switch is in the ON position.
- On petrol engine models with the multiport fuel injection (MFI) system, the fuel filter or fuel lines should be serviced by a NISSAN dealer or qualified workshop because the fuel lines are under high pressure even when the engine is off.
- Always wear eye protection whenever you work on your vehicle.
- Failure to follow these or other common sense guidelines may lead to serious injury or vehicle damage.



NISSAN Blue Citizenship

Improperly disposed engine oil and/or other vehicle fluids can pollute the environment. Always conform to local regulations for disposal of vehicle fluid.

This section gives instructions regarding only those items which are relatively easy for an owner to perform.

You should be aware that incomplete or improper servicing may result in operating difficulties or excessive emissions, and could affect your warranty coverage. **If in doubt about any servicing, have it done by your NISSAN dealer or qualified workshop.**

تلفن شبانه روزی: ۰۲۱-۸۸۸۶۲۰۸۵

FarmaSOS.com

For an overview of the engine compartment, see “Engine compartment” in the “0. Illustrated table of contents” section.

ENGINE COOLING SYSTEM

WARNING

- Never remove the engine coolant reservoir cap when the engine is hot. Serious burns could be caused by high pressure fluid escaping from the engine coolant reservoir. Wait until the engine and radiator have cooled down.
- Engine coolant is poisonous and should be stored carefully in marked containers out of the reach of children.

The engine cooling system is filled at the factory with a high-quality, year-round and extended life engine coolant. The high quality engine coolant contains the specific solutions effective for the anti-corrosion and the anti-freeze function. Therefore, additional cooling system additives are not necessary.

CAUTION

- Never use any cooling system additives such as radiator sealer. Additives may clog the cooling system and cause damage to the engine, transmission and/or cooling system.
- When adding or replacing engine coolant, be sure to use Genuine NISSAN engine coolant or equivalent.
- The use of other types of engine coolant may damage the engine cooling system.
- The engine coolant reservoir tank is equipped with a pressure cap, use a Genuine NISSAN cap or its equivalent when replacement is required.

CHECKING ENGINE COOLANT LEVEL

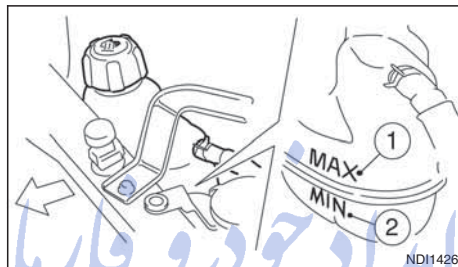

Check the coolant level in the reservoir when the engine is cold. If the coolant level is below MIN ②, add coolant up to the MAX ① level.

CAUTION

If the cooling system frequently requires coolant, have it checked by a NISSAN dealer or qualified workshop.

CHANGING ENGINE COOLANT

CAUTION

- Major cooling system repairs should be performed by a NISSAN dealer or qualified workshop. The service procedures can be found in the appropriate NISSAN Service Manual.
- When checking or replacement is required, NISSAN recommends contacting a NISSAN dealer or qualified workshop for servicing.

- Improper servicing or engine coolant change can result in reduced heater performance and engine overheating.

WARNING

- To avoid the danger of being scalded, never change the coolant when the engine is hot.
- Avoid direct skin contact with used coolant. If skin contact is made, wash thoroughly with soap or hand cleaner and plenty of water as soon as possible.
- Keep coolant out of reach of children and pets.

 NISSAN Blue Citizenship

Engine coolant must be disposed of properly. Check your local regulations.

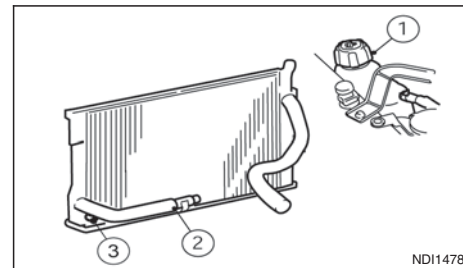

MR20DD, MR16DE or R9M engine

1. Set the heater or air conditioner temperature control to the maximum "HOT" position.
2. Open the bonnet. For details, see "Bonnet release" in the "3. Pre-driving checks and adjustments" section.
3. Open the engine coolant reservoir cap ① to help drain the coolant.
4. Loosen the engine coolant radiator drain plug ③ to help drain the coolant.
5. Disconnect the end of the hose ② to drain the coolant.
6. Flush the cooling system by running clean water through the engine coolant reservoir.
7. Install the hose ②.
8. Tighten the engine coolant radiator drain plug ③.
9. Fill the coolant reservoir up to the MAX level. See "Capacities and recommended fuel/lubricants" in the "9. Technical information" section for cooling system capacity.
10. Install the engine coolant reservoir cap.
11. Start the engine, and rev the engine two or three times under no load.
12. Touch the radiator hose and feel if the water flows.
13. Keep racing the engine at a speed of 3,000 rpm for about 10 minutes.

14. Observe the coolant temperature gauge for signs of overheating.
15. Stop the engine and check coolant level, allow to cool and refill up to the MAX level.
16. Check radiator lower hose for any signs of leakage.
17. Close the bonnet.

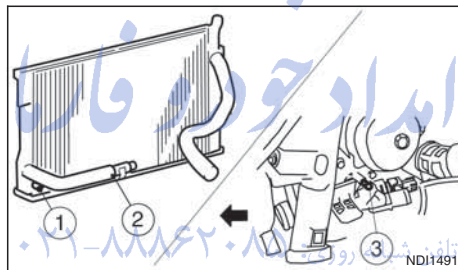

HRA2DDT or K9K engine

1. Set the heater or air conditioner temperature control to the maximum "HOT" position.
2. Open the bonnet. For details, see "Bonnet release" in the "3. Pre-driving checks and adjustments" section.
3. Loosen the engine coolant radiator drain plug ① to help drain the coolant.
4. Disconnect the radiator lower hose ② and open the drain plug ③ on the engine block.

5. Open the engine coolant reservoir cap to help to drain the coolant.
6. Flush the cooling system by running fresh water through the engine coolant reservoir.
7. Install the hose ② and securely tighten the engine block drain plug ③.
8. Tighten the engine coolant radiator drain plug ①.
9. Fill the reservoir up to the MAX level with coolant. See "Capacities and recommended fuel/lubricants" in the "9. Technical information" section for cooling system capacity.
10. Install the engine coolant reservoir cap.
11. Start the engine, and rev the engine two or three times under no load.
12. Touch the radiator hose and feel if the water flows.
13. Keep racing the engine at a speed of 2,000 – 2,500 rpm for about 10 minutes.
14. Observe the coolant temperature gauge for signs of overheating.
15. Stop the engine and check coolant level, allow to cool and refill up to the MAX level.
16. Check the radiator lower hose for any signs of leakage.
17. Close the bonnet.

ENGINE OIL

CHECKING ENGINE OIL LEVEL

CAUTION

The oil level should be checked regularly. Operating with an insufficient amount of oil can damage the engine, and such damage is not covered by warranty.

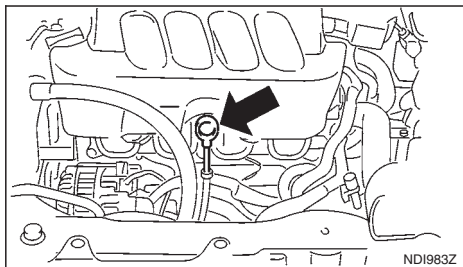

MR20DD engine

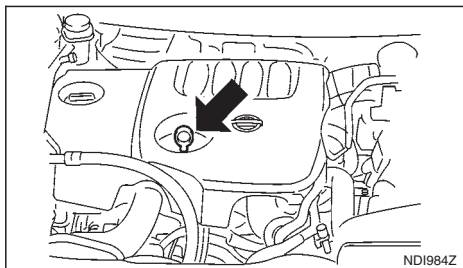

HRA2DDT engine

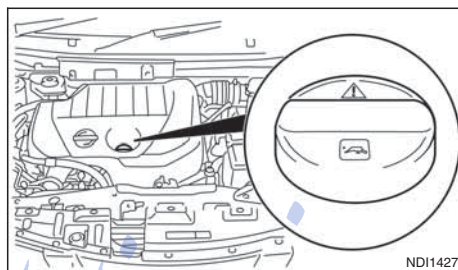

K9K engine

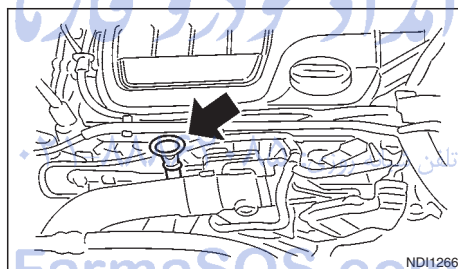

R9M engine

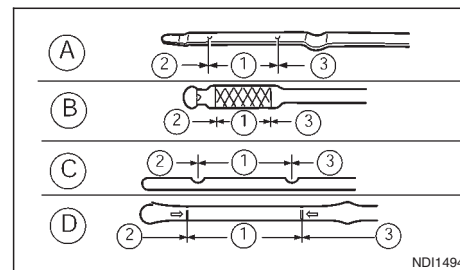

(A) MR20DD engine

(B) HRA2DDT

(C) R9M engine

(D) K9K engine G6

(1) Normal range

(2) MIN level

(3) MAX level

1. Park the vehicle on a level surface and apply the parking brake.
2. Start the engine. If the engine is cold, start and let the engine idle until it reaches the operational temperature.
3. Turn the engine off.
4. Wait at least 10 minutes for the engine oil to drain back into the oil pan.

5. Open the bonnet. For details, see “Bonnet release” in the “3. Pre-driving checks and adjustments” section.

6. Remove the dipstick and wipe it clean.

Models with K9K engine: the engine oil dipstick is attached to the engine oil filler cap. Remove the engine oil filler cap and wipe the dipstick clean.

7. Reinsert it all the way.

Models with K9K engine: install the engine oil filler cap.

8. Remove the dipstick again and check the oil level. It should be in the normal range ①.

9. If the oil level is below MIN ②, remove the engine oil filler cap and pour the recommended oil through the opening. **Do not overfill** ③.

10. Recheck the oil level with the dipstick.

11. Install the engine oil filler cap securely.

12. Close the bonnet.

It is normal to add some engine oil between oil maintenance intervals depending on the severity of operating conditions or depending on the property of the engine oil used. More engine oil is consumed by frequent acceleration/deceleration especially when the engine rpm is high. Consumption is likely to be higher when the engine is new. If the rate of oil consumption, after having driven for 5,000 km (3,000 miles), is more

than 0.5 litre per 1,000 km (621 miles), consult a NISSAN dealer or qualified workshop.

CHANGING ENGINE OIL



WARNING

- NISSAN recommends contacting a NISSAN dealer or qualified workshop for engine oil servicing.



NISSAN Blue Citizenship

Used oil must not be poured into the ground, canals, rivers, etc. It should be disposed of at a rubbish tip having proper facilities. Check your local regulations.

- Be careful not to burn yourself, as the engine oil is hot.
- Prolonged and repeated contact with used engine oil may cause skin cancer.
- Avoid direct skin contact with used oil. If skin contact is made, wash thoroughly with soap or hand cleaner and plenty of water as soon as possible.
- Store used engine oil in marked containers out of the reach of children.

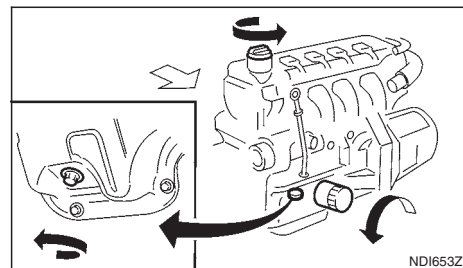

MR20DD engine

NDI653Z

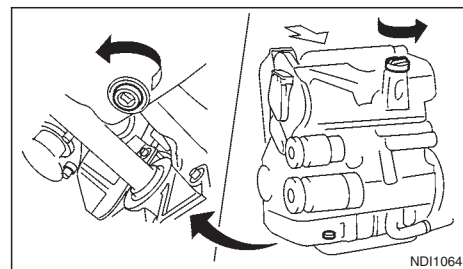

K9K engine

NDI1064

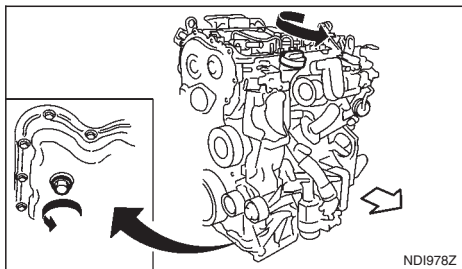

R9M engine

NDI978Z

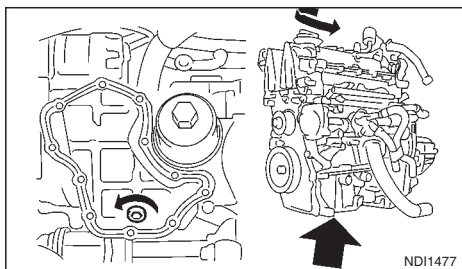

HRA2DDT engine

NDI147Z

1. Park the vehicle on a level surface and apply the parking brake.
2. Start the engine. If the engine is cold, start and let the engine idle until the engine temperature reaches the operational temperature.
3. Turn the engine off and wait at least 10 minutes to let the engine oil drain back into the oil pan.

4. Open the bonnet. For details, see "Bonnet release" in the "3. Pre-driving checks and adjustments" section.
5. Remove the engine oil filler cap.
6. Raise and support the vehicle using a suitable floor jack and safety jack stands.

Place the safety jack stands under the vehicle jack-up points.

For details, see "Flat tyre" in the "6. In case of emergency" section.

7. Remove the engine compartment under cover.
8. Place a large drain pan under the drain plug.
9. Remove the drain plug with a wrench and completely drain the oil.

If the engine oil filter needs to be changed, remove and replace it at this time. See "Changing engine oil filter" later in this section.

10. Clean and re-install the drain plug along with a new washer. Securely tighten the drain plug with a wrench. **Do not use excessive force.**

Drain plug tightening torques:

- MR20DD engine:**
34.3 N•m (3.5 kg-m, 25 ft-lb)
- K9K engine:**
20 N•m (2.1 kg-m, 15 ft-lb)
- R9M engine:**
50 N•m (5.1 kg-m, 36.9 ft-lb)

11. Refill the engine with recommended engine oil and quantity.

See "Capacities and recommended fuel/lubricants" in the "9. Technical information" section.

12. Check the oil level with the dipstick. For details, see "Checking engine oil level" earlier in this section. If necessary, add engine oil.
13. Install the engine oil filler cap securely.
14. Start the engine.
15. Check for any leakage around the drain plug. Correct as required.
16. Turn the engine off and wait several minutes.
17. Check the oil level again with the dipstick. If necessary, add engine oil.
18. Install the engine compartment under cover.
19. Lower the vehicle carefully to the ground.
20. Close the bonnet.

CHANGING ENGINE OIL FILTER



WARNING

- **NISSAN recommends contacting a NISSAN dealer or qualified workshop for engine oil filter servicing.**



NISSAN Blue Citizenship

A used oil filter should be disposed of at a rubbish tip having proper facilities.

MR20DD and K9K engines

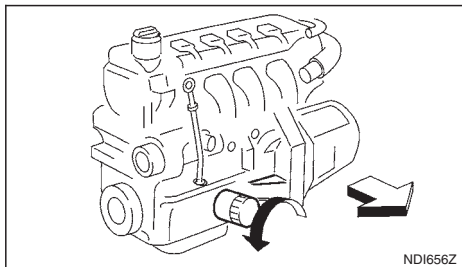

MR20DD engine

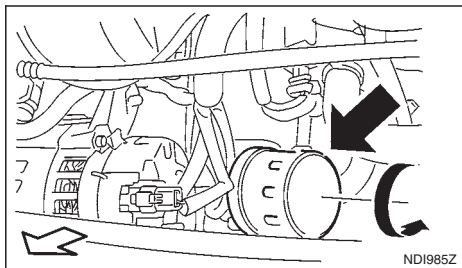

K9K engine

Removal:

1. Drain the engine oil. For details, see "Changing engine oil" earlier in this section.
2. Loosen the engine oil filter unit with an oil filter wrench. Depending on the engine model, a special **cap type** wrench may be required. See a NISSAN dealer or qualified workshop, if in doubt.

3. Remove the engine oil filter unit.
4. Wipe the engine oil filter mounting surface with a clean rag.

CAUTION

If any oil is spilled on the engine or the vehicle, thoroughly wipe it clean.

Installation:

1. Clean and re-install the drain plug along with a new washer. For tightening torque details, see "Changing engine oil" earlier in this section.
2. Coat the rubber gasket on the new engine oil filter unit with clean engine oil.
3. Install the engine oil filter unit by hand until a slight resistance is felt, then tighten additionally $\frac{2}{3}$ of a turn.

Engine oil filter tightening torques:

MR20DD engine

17.7 N•m (1.8 kg-m, 13 ft-lb)

K9K engine:

14 N•m (1.4 kg-m, 10 ft-lb)

4. Add engine oil and check the oil level with the engine oil dipstick. For details, see "Checking engine oil level" earlier in this section and "Capacities and recommended fuel/lubricants" in the "9. Technical information" section.
5. Install the engine oil filler cap.
6. Start the engine.

7. After the engine has been warmed up, make sure there are no leaks around the engine oil filter unit and the drain plug. Correct as required.
8. Turn the engine off and wait several minutes. Check the oil level and add engine oil, if necessary.
9. Install the engine compartment under cover.
10. Lower the vehicle carefully to the ground.
11. Close the bonnet.

R9M and HRA2DDT engines

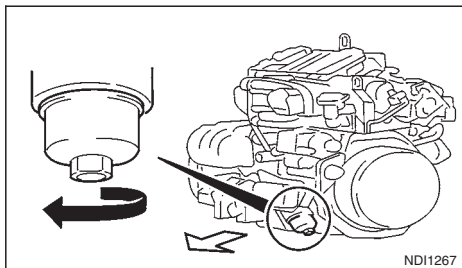

R9M

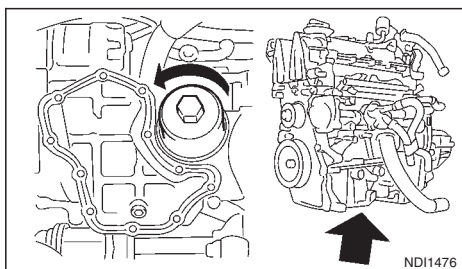

HRA2DDT

Removal:

1. Drain the engine oil. For details, see "Changing engine oil" earlier in this section.
2. Loosen the engine oil filter cover with a wrench.
3. Remove the engine oil filter cover then the oil filter element.
4. Remove the rubber O-ring from the filter cover.

5. Wipe the oil filter cover entirely with a clean rag.

Installation:

1. Clean and re-install the drain plug along with a new washer. For tightening torque details, see "Changing engine oil" earlier in this section.
2. Install the rubber O-ring, in its housing, on the outside of the engine oil filter cover.
3. Insert the new oil filter element into the engine oil filter cover.
4. Coat the rubber O-ring with clean engine oil.
5. Install the engine oil filter cover until a slight resistance is felt, then tighten additionally 2/3 of a turn.

Tightening torque:

25 N•m (2.6 kg-m, 18 ft-lb)

6. Add engine oil and check the oil level with the engine oil dipstick. For details, see "Checking engine oil level" earlier in this section and "Capacities and recommended fuel/lubricants" in the "9. Technical information" section.
7. Install the engine oil filler cap.
8. Start the engine.
9. After the engine has been warmed up, make sure there are no leaks around the engine oil filter cover and the drain plug. Correct as required.
10. Turn the engine off and wait several minutes. Check the oil level and add engine oil, if necessary.
11. Install the engine compartment under cover.

12. Lower the vehicle carefully to the ground.

13. Close the bonnet.

PROTECT THE ENVIRONMENT



NISSAN Blue Citizenship

It is illegal to pollute drains, water courses and soil. Use authorised waste collection facilities, including civic amenity sites and garages providing facilities for the disposal of used oil and used oil filters. If in doubt, contact your local authority for advice on disposal.

The regulations concerning the pollution of the environment will vary from country to country.

FUEL FILTER (Diesel engine models)

DRAINING WATER

Drain the water from the fuel filter. Contact a NISSAN dealer or qualified workshop.:

BLEEDING THE FUEL SYSTEM

There is no need to perform any special operation to bleed air from the system.



NISSAN Blue Citizenship

Fuel bled from the fuel filter must not be poured into the ground, canals, rivers, etc. It should be disposed of at a rubbish tip having proper facilities. Check your local regulations.

XTRONIC CONTINUOUSLY VARIABLE TRANSMISSION (CVT) FLUID

When checking or replacement is required, NISSAN recommends contacting a NISSAN dealer or qualified workshop for servicing.

CAUTION

- Use only Genuine NISSAN CVT Fluid NS3*. Do not mix with other fluids.
- Using transmission fluid other than Genuine NISSAN CVT Fluid NS3* will damage the XTRONIC transmission, which is not covered by the warranty.

*: For details, contact a NISSAN dealer or qualified workshop.

تلفن شبانه روزی: ۰۲۱-۸۸۶۲۰۸۵

FarmaSOS.com

BRAKES

CHECKING PARKING BRAKE

Periodically check the holding ability of the parking brake by parking on a steep hill and restraining the vehicle by using only the parking brake. If it does not hold satisfactorily, see a NISSAN dealer or qualified workshop.

CHECKING BRAKE PEDAL

If the brake pedal suddenly goes down further than normal, the pedal feels "spongy" or the vehicle seems to take longer to stop, see a NISSAN dealer or qualified workshop.

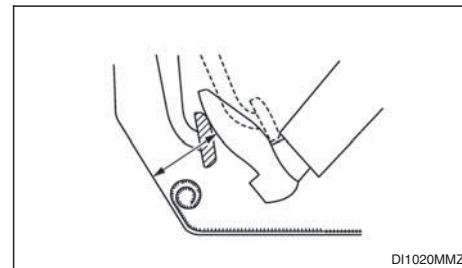

WARNING

See a NISSAN dealer or qualified workshop for a brake system check if the brake pedal height does not return to normal.

With the engine running, check the distance between the upper surface of the pedal and the metal floor. If it is out the range listed, see a NISSAN dealer or qualified workshop.

Depressing force of 490 N (50 kg, 110 lb)

183.7 – 193.7 mm (7.23 – 7.63 in.)

Self-adjusting brakes

Your vehicle is equipped with self-adjusting brakes. The disc-type brakes self-adjust every time the brake pedal is applied.

BRAKE BOOSTER

Check the brake booster function as follows:

1. With the engine off, depress and release the footbrake pedal several times. When the footbrake pedal movement (distance of travel) remains the same from one pedal application to the next, continue on to the next step.
2. While depressing the footbrake pedal, start the engine. The pedal height should drop a little.
3. With the footbrake pedal depressed, stop the engine. Keep the pedal depressed for about 30 seconds. The pedal height should not change.
4. Run the engine for 1 minute without depressing the footbrake pedal, then turn it off. Depress the footbrake pedal several times. The pedal travel distance will decrease gradually with each depression as the vacuum is released from the booster.

If the brakes do not operate properly, have the brakes checked by a NISSAN dealer or qualified workshop.

امداد خودرو فارما

تلفن شبانه روزی: ۰۲۱-۸۸۸۶۲۰۸۵

FarmaSOS.com

BRAKE AND CLUTCH FLUID

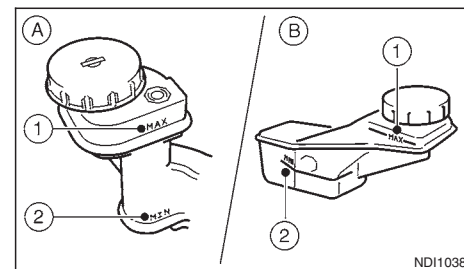

(A) LHD models

(B) RHD models



WARNING

- Use only new fluid. Old, inferior, or contaminated fluid may damage the brake and clutch systems. The use of improper fluids can damage the brake system and affect the vehicle's stopping ability.
- Clean the filler cap before removing.
- Brake and clutch fluids are poisonous and should be stored carefully in marked containers out of the reach of children.

Check the fluid level in the reservoir. If the fluid level is between the MIN (2) and MAX (1) lines or the brake warning light comes on, add fluid up to the MAX line.

WINDOW WASHER FLUID/HEADLIGHT CLEANER FLUID (where fitted)

See "Capacities and recommended fuel/lubricants" in the "9. Technical information" section for the recommended brake and clutch fluid type.

If fluid must be added frequently, the system should be thoroughly checked by a NISSAN dealer or qualified workshop.

CAUTION

- NISSAN recommends that refilling and checking the brake and clutch systems should be left to a NISSAN dealer or qualified workshop who will have the necessary fluids and technical knowledge.
- Do not spill the fluid on painted surfaces. This will damage the paint. If fluid is spilled, wash with water.

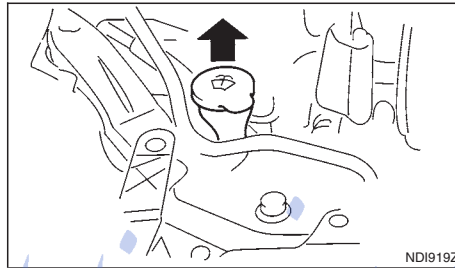

WARNING

Anti-freeze window washer is poisonous and should be stored carefully in marked containers out of the reach of children.







- Check the fluid level in the window washer reservoir. If the fluid level is low, add window washer fluid up to the MAX level.
- Refill the reservoir more frequently when driving conditions require an increased amount of window washer fluid.
- Add a washer solvent to the water for better cleaning. In the winter season, add a window washer anti-freeze. Follow the manufacturer's instructions for the mixture ratio.

CAUTION

- Do not substitute anti-freeze engine coolant for window washer solution. This may result in damage to the paint.

- Always use window washer fluid recommended by NISSAN.

BATTERY

Caution symbols for battery			 WARNING
①		No smoking No exposed flames No sparks	Never smoke around the battery. Never expose the battery to open flames or electrical sparks.
②		Shield eyes	Handle the battery cautiously. Always wear eye protection glasses to protect against explosion or battery acid.
③		Keep away from children	Never allow children to handle the battery. Keep the battery out of reach of children.
④		Battery acid	Do not allow battery fluid to contact your skin, eyes, fabrics, or painted surfaces. After handling the battery or battery cap, immediately wash your hands thoroughly. If the battery fluid gets into your eyes, or onto your skin or clothing, flush with water immediately for at least 15 minutes and seek medical attention. Battery fluid is acid. If the battery fluid gets into your eyes or onto your skin, it could cause eyesight loss or burns.
⑤		Note operating instructions	Before handling the battery, read this instruction carefully to ensure correct and safe handling.
⑥		Explosive gas	Hydrogen gas, generated by battery fluid, is explosive.

VEHICLE BATTERY



Do not operate the vehicle if the fluid in the battery is low. Low battery fluid can cause a higher load on the battery which can generate heat, reduce battery life, and in some cases lead to an explosion.

- Keep the battery surface clean and dry. Any corrosion should be washed off with a solution of baking soda and water.
- Make certain the terminal connections are clean and securely tightened.
- If the vehicle is not used for 30 days or longer, disconnect the “-” negative battery terminal cable to prevent discharge.
- If battery replacement or check is required, contact a NISSAN dealer or qualified workshop.

Battery (Type A)

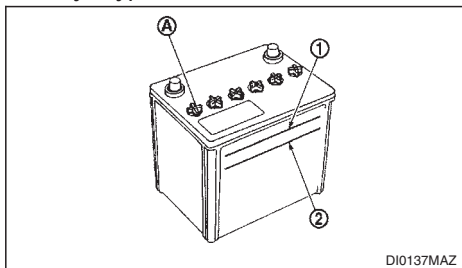

Check the fluid level in each cell. It should be between the UPPER ① and LOWER ② level lines.

If it is necessary to add fluid, add only distilled water to bring the level to the indicator in each filler opening. **Do not overfill.**

1. Remove the cell plugs (A) using a suitable tool.

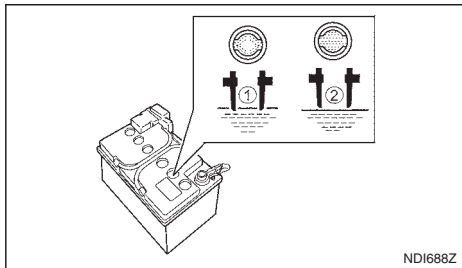

Indicator

① OK

② ADD

2. Add distilled water up to the UPPER level line ①.

If the side of the battery is not clear, check the electrolyte water level by looking directly above the cell, as illustrated.

3. Tighten cell plugs.

CAUTION

Do not overfill battery cells. Excessive electrolyte may leak out of the battery during charging, and cause paint damage.

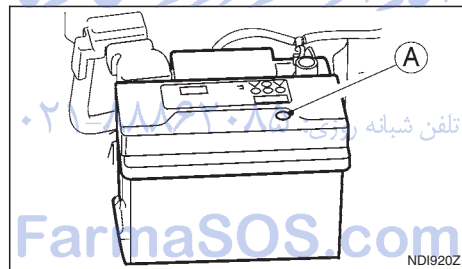

Maintenance free battery (Type B)

For a maintenance free battery it is not required to check the fluid level. However, NISSAN recommends to visually check the green indicator (A) status periodically. If it is not visible, replace the battery as soon as possible.

Reinitialisation procedure after battery reconnection

If the battery has been reconnected, check the following items:

- Clock setting (where fitted). For details, see “Vehicle information display” in the “2. Instruments and controls” section, or the separately provided NissanConnect Owner’s Manual, or the audio device descriptions in “FM AM radio with CD player (where fitted)” in the “4. Display screen, heater and air conditioner, and audio system” section.
- Reset the desired radio stations to the preset station buttons. For details, see the audio device descriptions in the “4. Heater and air conditioner, and audio system”.

Models with Stop/Start System

- Ensure that the battery fitted is the special battery that is enhanced with regard to the charge-discharge capacity and life performance. Avoid using any other battery for the Stop/Start System, as this may cause early deterioration of the battery or a malfunction of the Stop/Start System. It is recommended that a Genuine NISSAN battery is fitted. For more information, contact a NISSAN dealer or qualified workshop.
- If the battery terminal is disconnected (for battery replacement, etc.) and then reconnected, there may be some delay before the Stop/Start System reactivates.

JUMP-STARTING

If jump-starting is necessary, see "Jump-starting" in the "6. In case of emergency" section. If the engine does not start by jump starting, the battery may have to be replaced. Contact a NISSAN dealer or qualified workshop.

INTEGRATED KEYFOB/INTELLIGENT KEY BATTERY REPLACEMENT

CAUTION

- Be careful not to touch a circuit board or a battery terminal.



NISSAN Blue Citizenship

An improperly disposed battery can harm the environment. Always conform to local regulations for battery disposal.

- The Integrated keyfob/Intelligent Key is water-resistant; however, if it does get wet, immediately wipe it until it gets completely dry. To replace the battery, open the Integrated keyfob/Intelligent Key carefully in the sequence shown in the illustration.
- When changing the battery, do not let dust or oil get on the Integrated keyfob/Intelligent Key.

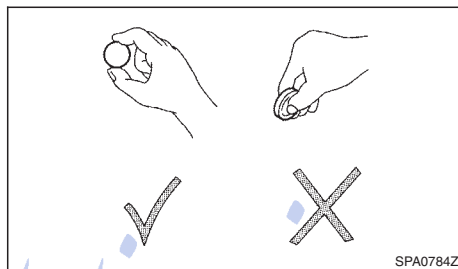

CAUTION

Always hold the battery by the edges, as shown. Holding the battery across the contact points will seriously deplete the storage capacity.

تلفن شبانه روزی: ۰۲۱-۸۸۸۶۲۰۸۵

FarmaSOS.com

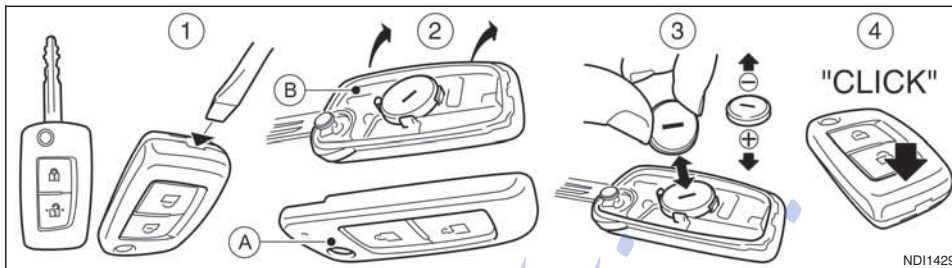

Integrated keyfob

Replacement

1. Insert a flat blade screwdriver or a suitable tool into the slot and twist it to open the lid.
2. Keeping the front (A) pointing downward as shown lift the rear (B) of the key.
3. Replace the battery with a new one.

For models equipped with Integrated keyfob, use the following battery type:

CR2032

- Do not touch the internal circuit and electric terminals as doing so could cause a malfunction.
 - Make sure that the + side faces the bottom of the case, as illustrated.
4. Install the lid in the reverse order of removal and press firmly.
 5. Operate the buttons to check that the key works correctly.

Contact a NISSAN dealer or qualified workshop if you need assistance for battery replacement.

تلفن شبانه روزی: ۰۲۱-۸۸۸۶۲۰۸۵

FarmaSOS.com

DRIVE BELTS



WARNING

Be sure the ignition switch is in the "OFF" or LOCK position. Otherwise the cooling fan or the engine may start to operate suddenly.

1. Visually inspect each belt for signs of unusual wear, cuts, fraying or looseness. If the belt is in poor condition or loose, have it replaced or adjusted by a NISSAN dealer or qualified workshop.
2. Have the belts checked regularly for condition and tension in accordance with the maintenance schedule as shown in a separately provided Warranty Information and Maintenance booklet.

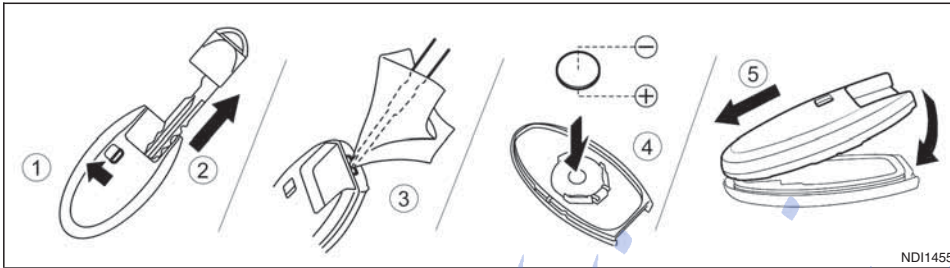

Intelligent Key

Replacement

1. Slide the locking pin to the unlock position.
2. Remove the key.
3. Insert a flat blade screwdriver or a suitable tool into the slot and twist it to open the lid.
4. Replace the battery with a new one with the same specifications.

For models equipped with Intelligent Key, use the following battery type:

CR2032

- Do not touch the internal circuit and electric terminals as doing so could cause a malfunction.
- Make sure that the + side faces the bottom of the case, as illustrated.

5. Install the lid in the reverse order of removal.

6. Operate the buttons to check that the key works correctly.

Contact a NISSAN dealer or qualified workshop if you need assistance for battery replacement.

تلفن شبانه روزی: ۰۲۱-۸۸۶۲۰۸۵

FarmaSOS.com

SPARK PLUGS (Petrol engine models)



WARNING

Be sure the engine and ignition switch are off and that the parking brake is engaged securely.

CAUTION

- Be sure to use the correct socket to remove the spark plugs. An incorrect socket can cause damage to the spark plugs.
- Always replace spark plugs with recommended or equivalent ones.

Replace spark plugs according to the maintenance schedule shown in the separately provided Warranty Information & Maintenance Booklet.

If replacement is required, see a NISSAN dealer or qualified workshop for servicing.

AIR DUCT REMOVAL

NOTE

Some maintenance procedures require the removal of the air duct.

Be sure the ignition switch is in the "OFF" or LOCK position before working in the engine compartment.

امداد خودرو فارما

تلفن شبانه روزی: ۰۲۱-۸۸۸۶۲۰۸۵

FarmaSOS.com

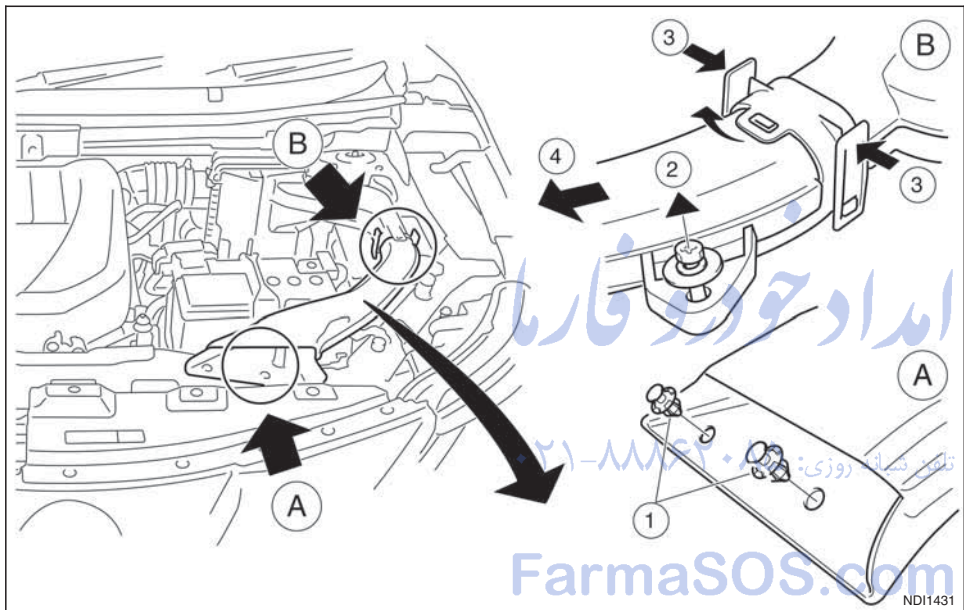

- 1) Remove the clips.
- 2) Remove the bolt.
- 3) Push the top of the retaining clips together to release the air duct.
- 4) Slide the air duct towards the front of the vehicle to remove it.

Install the air duct in the reverse order of removal.

AIR CLEANER FILTER

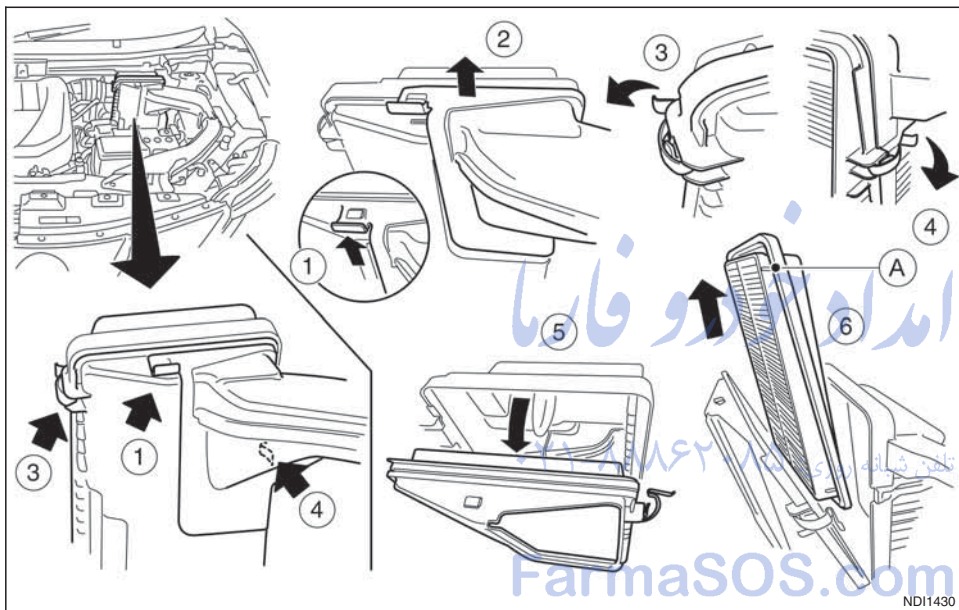

Replace it according to the maintenance schedule shown in the separately provided Warranty Information & Maintenance Booklet. When replacing the filter, wipe the inside of the air cleaner housing and the cover with a damp cloth.

DRY PAPER TYPE (where fitted)

Check the filter element (A) to see if it is dirty. If it is dirty, shake the element to remove dust.

Clean or replace it according to the maintenance schedule shown in the separately provided Warranty Information & Maintenance Booklet. When cleaning or replacing the filter, wipe the inside of the air cleaner housing and the cover with a damp cloth.



WARNING

- Operating the engine without the air cleaner filter, can cause you or others to be burned. The air cleaner filter not only cleans the intake air, it also stops flame if the engine backfires. If the air cleaner filter is not installed and the engine backfires, you could be burned.

- Do not drive without the air cleaner filter.
- Be careful when working on the engine without the air cleaner filter.

VISCOUS PAPER TYPE

The filter element (A) should not be cleaned and reused.

WIPER BLADES

CLEANING

If the windscreen or back door window is not clear after using the window washer or if a wiper blade chatters when running, wax or other material may be on the blade or windscreen.

Clean the outside of the windscreen or back door window with a washer solution or a mild detergent. The windscreen or back door window is clean if beads do not form when rinsing with clear water.

Clean the blade by wiping it with a cloth soaked in a washer solution or a mild detergent. Then rinse the blade with clear water. If the windscreen or back door window is still not clear after cleaning the blades and using the wiper, replace the blades.

CAUTION

- After wiper blade replacement, return the wiper arm to its original position. Otherwise it may be damaged when the bonnet is opened.
- Make sure the wiper blade contacts the glass. Otherwise, the arm may be damaged from wind pressure.
- Do not open the bonnet when the front wiper is in the servicing position other wise it can damage the paint surface of the bonnet.

FRONT WINDOW WIPER REPLACEMENT

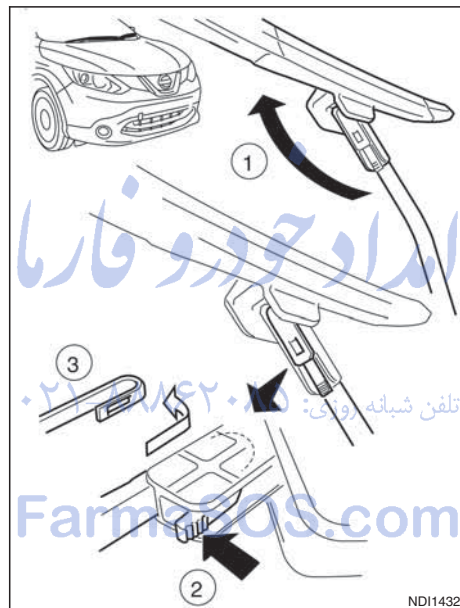

1. Pull up the wiper arm ①.
2. Press the lock pin ②, then remove the wiper blade as illustrated ③.
3. Install the new wiper blade in the reverse order of removal.

4. Return the wiper arm to its original position.

BACK DOOR WINDOW WIPER REPLACEMENT

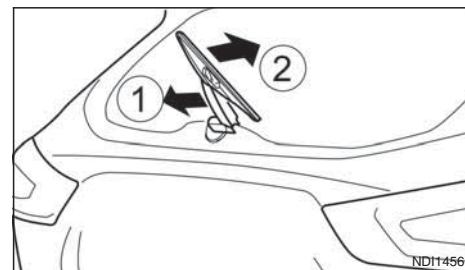

1. Lift the wiper arm ①.
2. Hold and rotate carefully the wiper blade clockwise until the blade becomes free ②.
3. Insert the new wiper blade onto the wiper arm and snap it into place.
4. Return the wiper arm to its original position.

FUSES

WINDSCREEN WASHER NOZZLE

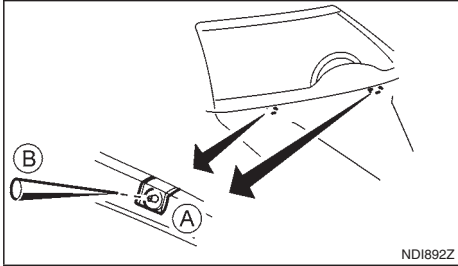

If you wax the surface of the engine bonnet, be careful not to let wax get into the washer nozzle (A). This may cause clogging or improper windscreen washer operation. If wax gets into the nozzle, remove it with a needle or small pin (B).

PASSENGER COMPARTMENT

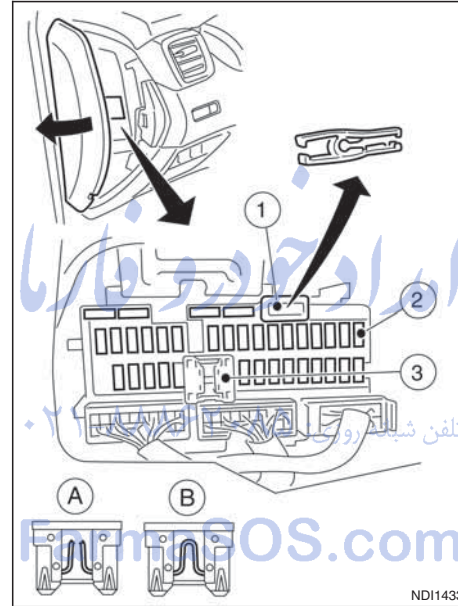

Left hand side

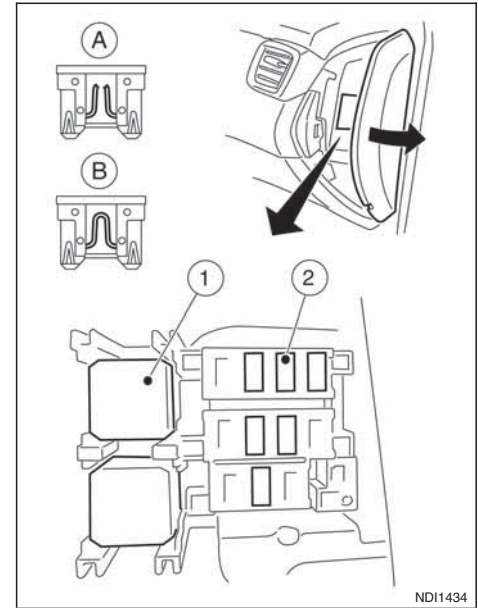

Right hand side

CAUTION

- Never use a fuse of higher or lower amperage rating than that specified on the fuse box cover.
- Never pull the harness or wires when disconnecting the connector.

- **Be careful not to damage the connector support bracket when disconnecting the connector.**

If any electrical equipment does not operate, check for an open fuse.

The fuse box is located in the lower part of the instrument panel at the driver's side.

The affected circuits (2) are shown on the inside of the fuse box lid.

1. Make sure the ignition switch and the headlight switch are in the "OFF" position.
2. Open the fuse box lid.
3. Locate and remove the fuse with the fuse puller (1) (where fitted).

NOTE

The fuse puller is stored in the fuse box.

4. If the fuse is open (A), replace it with a new fuse (B).
5. Close the fuse box lid.

NOTE

If the new fuse opens again, after installing, have the electrical system checked and repaired by a NISSAN dealer or qualified workshop.

Extended storage fuse switch

To reduce battery drain, the extended storage fuse switch (3) comes from the factory switched off. Prior to delivery of your vehicle, the switch is pushed in (switched on) and should always remain on.

If any electrical equipment does not operate, remove the extended storage fuse switch and check for an open fuse.

NOTE

If the extended storage fuse switch malfunctions or if the fuse is open, it is not necessary to replace the switch. In this case, remove the extended storage fuse switch and replace it with a new fuse of the same rating.

How to remove the extended storage fuse switch:

1. To remove the extended storage fuse switch, be sure the ignition switch is in the "OFF" or LOCK position.
2. Be sure the headlight switch is in the "OFF" position.
3. Remove the fuse box cover.
4. Pinch the locking tabs found on each side of the extended storage fuse switch (3).
5. Pull the extended storage fuse switch straight out from the fuse box.

ENGINE COMPARTMENT

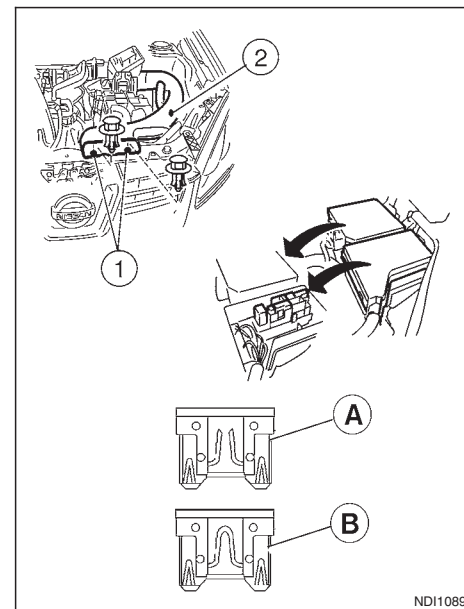

NDI1089

CAUTION

Never use a fuse of higher or lower amperage rating than that specified on the fuse box cover.

If any electrical equipment does not operate, check for an open fuse.

LIGHTS

1. Make sure the ignition switch and the headlight switch are in the "OFF" position.
2. Open the bonnet. For details, see "Bonnet release" in the "3. Pre-driving checks and adjustments" section.
3. Remove the air duct, see "Air duct removal" earlier in this section.
4. Remove the fusible link covers.
5. Locate the fuse that needs to be replaced.
6. Remove the fuse with the fuse puller (where fitted). The fuse puller is located in the fuse box of the passenger compartment.
7. If the fuse is open (A), replace it with a new fuse (B).
8. Install the fusible link covers.
9. Install the air duct in the reverse order of removal.
10. Close the bonnet.

NOTE

If the new fuse opens again, after installing, have the electrical system checked and repaired by a NISSAN dealer or qualified workshop.

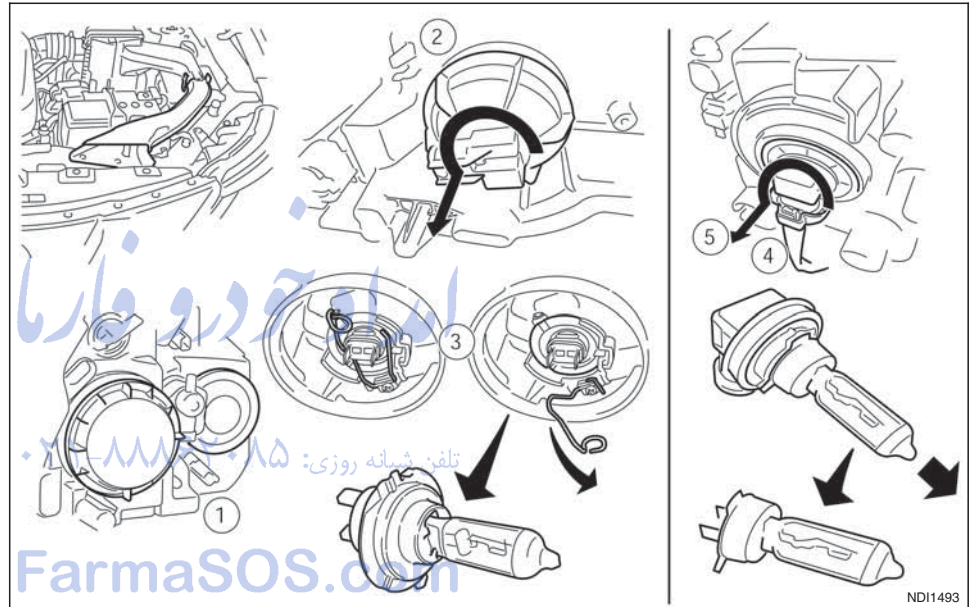

HEADLIGHTS

LED headlight (where fitted)

The LED headlight is a projector style which uses a LED module without serviceable parts.

CAUTION

- To prevent an electric shock, never attempt to modify or disassemble the LED headlights assembly.
- If replacement is required, contact a NISSAN dealer or qualified workshop.

Replacing the halogen headlight bulb

CAUTION

- High pressure halogen gas is sealed inside the halogen bulb. The bulb may break if the glass envelope is scratched or the bulb is dropped.
- When handling the bulb, DO NOT TOUCH THE GLASS ENVELOPE.
- Use the same number type and wattage as originally installed.
- Aiming is usually not necessary after replacing the bulb. When aiming adjustment is necessary, contact a NISSAN dealer or qualified workshop.
- Do not leave the bulb out of the headlight reflector for a long period of time as dust,

moisture or smoke may enter the headlight body and affect the performance of the headlight.

The headlight is a semi-sealed beam type which uses a replaceable headlight (halogen) bulb. A bulb can be replaced from inside the engine compartment without removing the headlight assembly.

Contact a NISSAN dealer or qualified workshop, if you need assistance for bulb replacement.

High beam bulb replacement:

1. Open the bonnet. For details, see "Bonnet release" in the "3. Pre-driving checks and adjustments" section.
2. Disconnect the negative (—) battery cable.
3. When the broken bulb is located in the headlight assembly under the air duct, carefully remove the air duct, see "Air duct removal" earlier in this section.
4. Remove the connector from the back of the cover assembly ①.
5. Turn the cover assembly 1/4 of a turn in the anti clockwise direction and remove the cover by disconnecting the internal connector ②.
6. Push and turn the retaining pin to loosen it ③.
7. Remove the headlight bulb. Do not shake or rotate the bulb when removing it.
8. Install the new bulb in the reverse order of removal.

9. Re-install the covers internal connector on the back of the bulb.
10. Re-install the cover by turning the cover assembly 1/4 of a turn in the clockwise direction.
11. Re-install the connector on the back of the cover assembly.
12. Where removed (step 3.), re-install the air duct, bolt and clips in the reverse order of removal.
13. Reconnect the negative (—) battery cable and close the bonnet.

Low beam bulb replacement:

1. Open the bonnet. For details, see "Bonnet release" in the "3. Pre-driving checks and adjustments" section.
2. Disconnect the negative (—) battery cable.
3. When the broken bulb is located in the headlight assembly under the air duct, carefully remove the air duct, see "Air duct removal" earlier in this section.
4. Remove the connector from the back of the bulb assembly ④.
5. Turn the bulb assembly 1/8 of a turn in the anti clockwise direction and remove the headlight bulb ⑤.
6. Install the new bulb in the headlight body by turning it clockwise until it is securely sealed within the headlight body.
7. Re-install the connector on the back of the bulb assembly.

8. Where removed (step 3.), re-install the air duct, bolt and clips in the reverse order of removal.
9. Reconnect the negative (–) battery cable and close the bonnet.

NOTE

Fog may temporarily form inside the lens of the exterior lights in the rain or in a car wash. The fog is caused by a temperature difference between the inside and the outside of the lens. This is not a malfunction. If large droplets can be seen, then contact a NISSAN dealer or qualified workshop.

EXTERIOR LIGHTS

Item	Wattage (W)
Front combination light	
Headlight (Low beam: H11 type)	55
Headlight (High beam: H7 type)	60
Headlight (Low or high beam: LED type, where fitted) *1	LED
Front turn signal light	21
Front side light *1	LED
Front fog light (H8 type, where fitted) *1	35
Side turn signal light *1	LED
Rear combination light	
Turn signal light	21
Stop/Tail light *1	LED
Reverse light *1	16
High-mounted stop light *1	LED
Number plate light	5
Rear fog light	21

*1: If replacement is required, contact a NISSAN dealer or qualified workshop.

INTERIOR LIGHTS

Item	Wattage (W)
Room light/Map lights (where fitted)	5
Foot well light (where fitted)	3
Room light — rear (where fitted)	5
Reading lights — rear (where fitted)	8
Luggage compartment light	5

LIGHT LOCATIONS

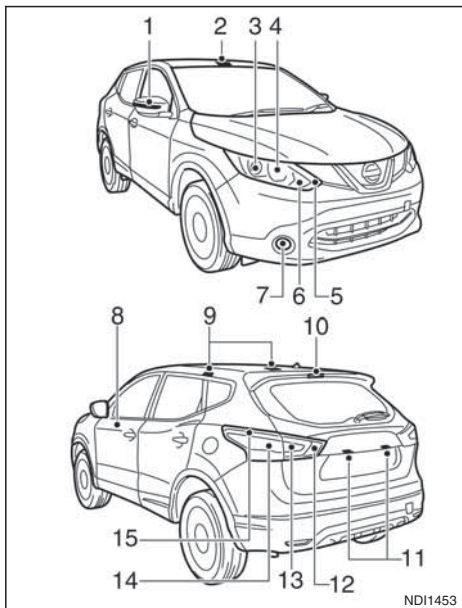

Light locations

- ① Side turn signal light
- ② Room light/Map lights (where fitted)
- ③ Low beam headlight
- ④ High beam headlight
- ⑤ Front side light

- ⑥ Front turn signal light
- ⑦ Front fog light (where fitted)
- ⑧ Footwell light (where fitted)
- ⑨ Room light (where fitted)
- ⑩ High mounted stop light
- ⑪ Number plate light
- ⑫ Rear fog light (where fitted)
- ⑬ Reverse light
- ⑭ Stop light
- ⑮ Tail light

تلفن شبانه روزی: ۰۲۱-۸۸۸۶۲۰۸۵

FarmaSOS.com

Replacing procedures

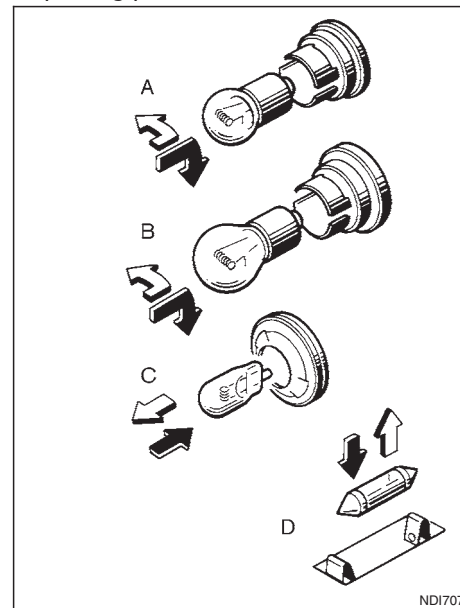

All other lights are either type A, B, C or D.
When replacing a bulb, first remove the lens and/or cover.

⇨ REMOVE

➔ INSTALL

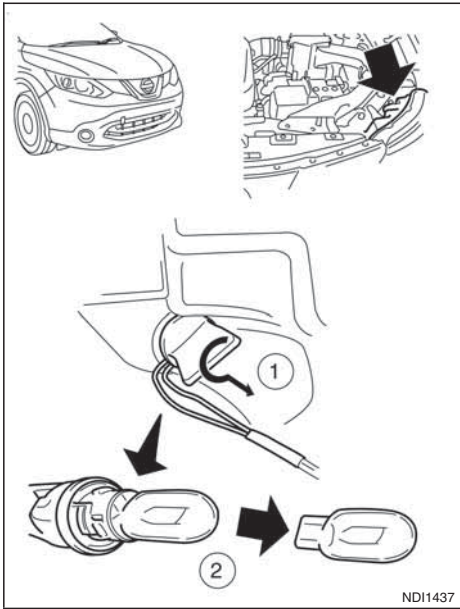

Front turn signal light

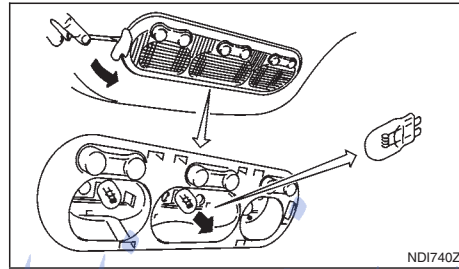

Room light / Map lights (where fitted)

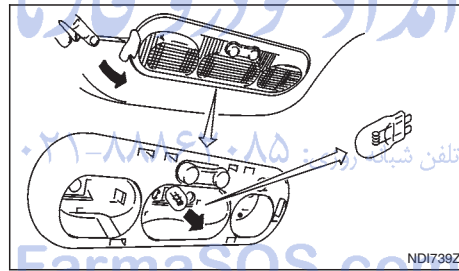

Room light — rear (where fitted)

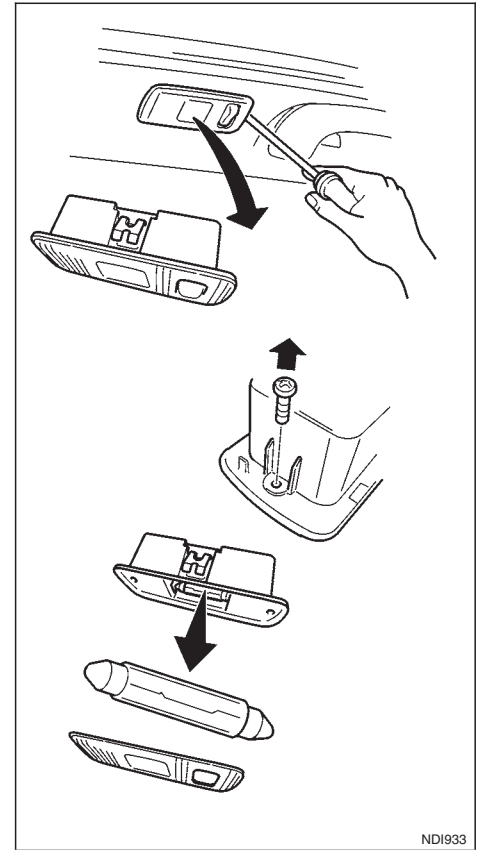

Reading light — rear (where fitted)

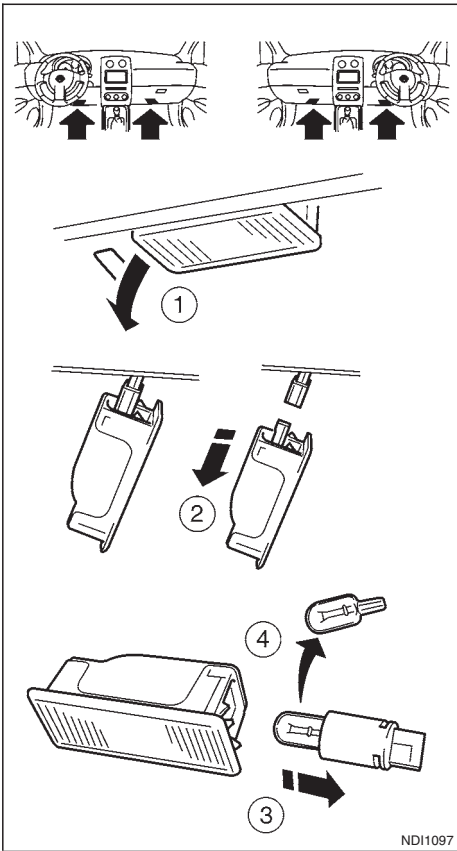

Foot well light (where fitted)



Luggage compartment light

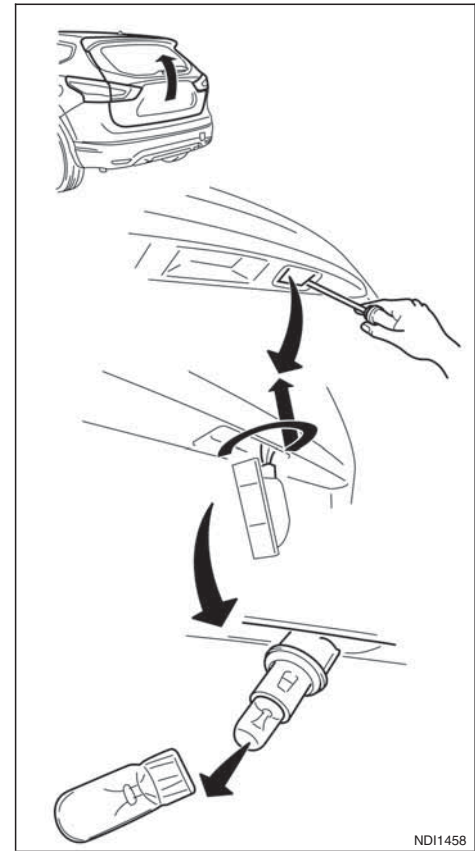

Number plate light

WHEELS AND TYRES

In case of a flat tyre, see “Flat tyre” in the “6. In case of emergency” section.

TYRE INFLATION PRESSURE

Periodically check the tyre pressure (including the spare tyre). An incorrect tyre pressure may adversely affect tyre life and vehicle handling. After adjusting the tyre pressure, perform a TPMS temperature calibration (see “TPMS temperature calibration” in the “5. Starting and driving” section).

NOTE

Incorrectly inflated tyres can also lead to poor steering ability and make the driver suspect a steering problem: keep the vehicle’s tyres inflated to the correct pressure at all times.

The tyre pressure should be checked when tyres are COLD. Tyres are considered COLD after the vehicle has been parked for three or more hours, or driven less than 1.6 km (1 mile). COLD tyre pressures are shown on the tyre placard affixed to the driver’s side centre pillar.

Insufficient pressure can lead to an overheating of the tyre and subsequent internal damage. At high speeds, this could result in tread separation and even bursting of the tyre.

TYPES OF TYRES

CAUTION

- When changing or replacing tyres, be sure all four tyres are of the same type (i.e., summer, all season or snow) and construction.

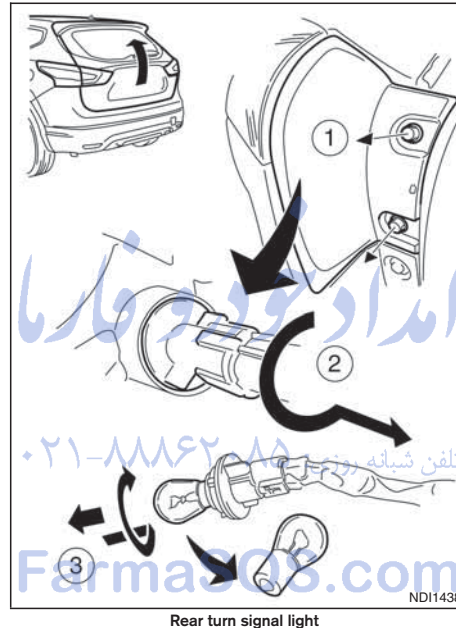
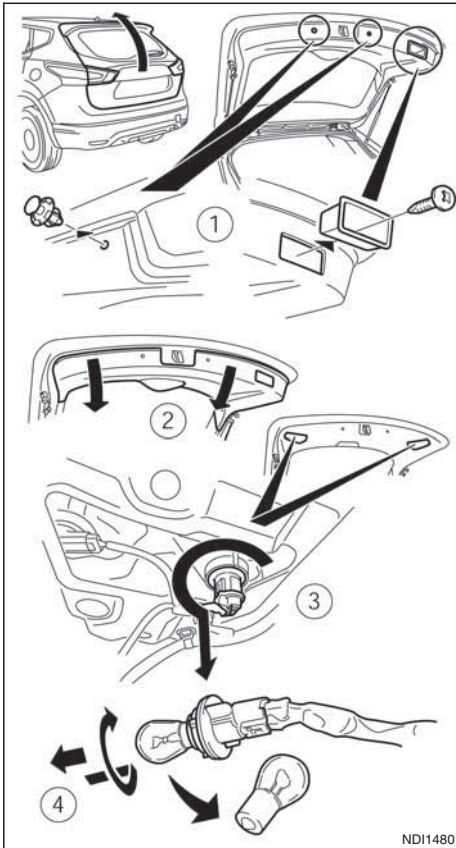

- A NISSAN dealer or qualified workshop may be able to help you with information about tyre type, size, speed rating and availability.
- Replacement tyres may have a lower speed rating than the factory equipped tyres, and may not match the potential maximum vehicle speed. Never exceed the maximum speed rating of the tyre.

All season tyres

NISSAN specifies all season tyres on some models to provide good performance for use all year around, including snowy and icy road conditions. All season tyres are identified by ALL SEASON and/or M&S on the tyre sidewall. Snow tyres have better snow traction than all season tyres and may be more appropriate in some areas.

Summer tyres

NISSAN specifies summer tyres as standard fit. These tyres provide superior performance under typical mild weather conditions.

If you plan to operate your vehicle in snowy or icy conditions, NISSAN recommends the use of SNOW or ALL SEASON tyres on all four wheels.

Snow tyres

If snow tyres are needed, it is necessary to select tyres equivalent in size and load rating to the original equipment tyres. If you do not, it can adversely affect the safety and handling of your vehicle.

Generally, snow tyres will have lower speed ratings

than factory equipped tyres and may not match the potential maximum vehicle speed. Never exceed the maximum speed rating of the tyre.

For additional traction on icy roads, studded tyres may be used. However, some provinces and states prohibit their use. Check local, state and provincial laws before installing studded tyres. Skid and traction capabilities of studded snow tyres, on wet or dry surfaces, may be poorer than that of non-studded snow tyres.

SNOW CHAINS

Use of snow chains may be prohibited in some areas. Check the local laws before installing snow chains. When installing snow chains, make sure they are of proper size for the tyres on your vehicle and are installed according to the chain manufacturer's suggestions. Use chain tensioners when recommended by the snow chain manufacturer to ensure a tight fit. Loose end links of the snow chain must be secured or removed to prevent the possibility of whipping action damage to the fenders or undercarriage.

In addition, drive at a reduced speed. Otherwise, your vehicle can be damaged and/or vehicle handling and performance may be adversely affected.

Snow chains must be installed only on the front wheels and not on the rear wheels.

CAUTION

- Never install snow chains on a temporary-use or small size spare tyre.

- Do not drive with snow chains on paved roads which are clear of snow. Driving with chains in such conditions can cause damage to the various mechanisms of the vehicle due to some overstress. When driving on clear paved roads, be sure to change to 2WD mode, see "Four-wheel Drive (4WD) (where fitted)" in the "5. Starting and driving" section.

TYRE ROTATION

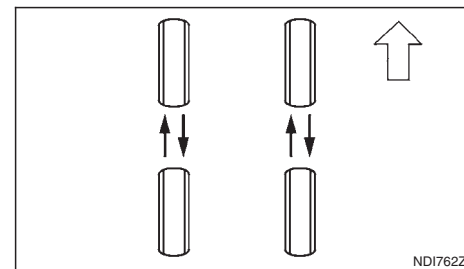

NISSAN recommends that tyres be rotated every 10,000 km (6,000 miles) for Two-Wheel Drive (2WD) vehicles and 5,000 km (3,000 miles) for Four-Wheel Drive (4WD) vehicles. After rotating tyres and adjusting the tyre pressure, perform a TPMS temperature calibration (see "TPMS temperature calibration" in the "5. Starting and driving" section).

See "Flat tyre" in the "6. In case of emergency" section for tyre replacing procedures.

WARNING

- After rotating the tyres, adjust the tyre pressure and perform a TPMS temperature calibration.
- Retighten the wheel nuts when the vehicle has been driven for the first 1,000 km (600 miles) (also in cases of a flat tyre, etc.).
- Do not include the temporary-use spare tyre in the tyre rotation.
- Incorrect tyre selection, fitting, care or maintenance can affect vehicle safety with risk of accident and injury. If in doubt, consult a NISSAN dealer or the tyre manufacturer.

TYRE WEAR AND DAMAGE

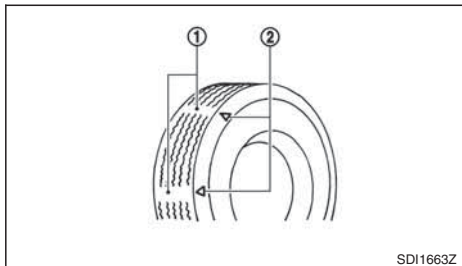

Tyres should be periodically inspected for wear, cracking, bulging or objects caught in the tread. If excessive wear, cracks, bulging or deep cuts are found, the tyre should be replaced.

The original tyres have a built-in tread wear indicator  ①. When the wear indicator is visible, the tyre should be replaced.

The wear indicator locations are indicated by the location marks  ②.

TYRE AGE

Remember tyre age. Never use a tyre over six years old, regardless of whether they have been used or not.

Tyres degrade with age as well as the use they are subjected to. Have the tyres checked and balanced frequently by a NISSAN dealer or qualified workshop. Report all accidents where the tyre is knocked even if it is minor.

CHANGING TYRES AND WHEELS



WARNING

Do not install a deformed wheel or tyre even if it has been repaired. Such wheels or tyres could have structural damage and could fail without warning.

When replacing a tyre, use the same size, speed rating and load carrying capacity as originally equipped. Recommended types and sizes are mentioned in "Wheels and Tyres" in the "9. Technical information" section.

The use of tyres other than those recommended or the mixed use of tyres of different brands, construction (bias, bias-belted or radial), or tread patterns can adversely affect the ride, braking, handling,

ground clearance, body-to-tyre clearance, snow chain clearance, speedometer calibration, headlight aim and bumper height.



WARNING

Some of these effects may lead to accidents and could result in serious personal injury.

If the wheels are changed for any reason, always replace with wheels which have the same offset dimension. Wheels of a different offset could cause early tyre wear, possibly degraded vehicle handling characteristics and/or interference with the brake discs. Such interference can lead to decreased braking efficiency and/or early brake pad wear.

FOUR-WHEEL DRIVE (4WD) MODELS

CAUTION

- Always use tyres of the same size, brand, construction (bias, bias-belted or radial), and tread pattern on all four wheels. Failure to do so may result in a circumference difference between tyres on the front and rear axles which will cause excessive tyre wear and may damage the transmission, transfer case and differential gears.
- ONLY use spare tyres specified for the four wheel drive (4WD) models.

WHEEL BALANCE

Unbalanced wheels may affect vehicle handling and tyre life. Even with regular use, wheels can get out of balance. Therefore, they should be balanced as required.

Wheel balance service should be performed with the wheels off the vehicle. Spin balancing the front wheels on the vehicle could lead to transmission damage.

SPARE TYRE

The temporary-use spare wheel/tyre can be identified by the temporary-use spare tyre label which contrasts to the standard road wheels. If in doubt, contact a NISSAN dealer, qualified workshop or see "Spare tyre" in the "6. In case of emergency" section.

Emergency tyre puncture repair kit (where fitted)

The emergency tyre puncture repair kit is supplied to the vehicle instead of a spare tyre. The repair kit must be used for temporarily fixing a minor tyre puncture. After using the repair kit, see a NISSAN dealer or qualified workshop as soon as possible for tyre inspection and repair/replacement.

CAUTION

Do not use the emergency tyre puncture repair kit under the following conditions. Contact a NISSAN dealer or qualified workshop or professional road assistance.

- when the sealant has passed its expiration date (shown on the label attached to the sealant bottle)
- when the cut or the puncture is approximately 4 mm (0.16 in) or longer
- when the side of the tyre is damaged
- when the vehicle has been driven with a considerable loss of air from the tyre
- when the tyre is completely displaced inside or outside the rim
- when the tyre rim is damaged
- when two or more tyres are flat

See "Spare tyre" in the "6. In case of emergency" section for more details.

CARE OF WHEELS تلفن شبانه روزی: ۸۵

For details, see "Care of wheels" in the "7. Appearance and care" section.

FarmaSOS.com

9 Technical information

Capacities and recommended fuel/lubricants	9-2	Engine serial number	9-7
Fuel information	9-4	Tyre placard	9-8
Recommended SAE viscosity number	9-4	Air conditioner specification label (where fitted)	9-8
Engine	9-5	Approval numbers	9-8
Wheels and Tyres	9-5	NISSAN Anti-Theft System (NATS), Intelligent or remote keyless system	9-8
Dimensions	9-6	Tyre Pressure Monitoring System (TPMS) (Transmitter)	9-9
When travelling or transferring your registration to another country	9-6		
Vehicle identification	9-6		
Vehicle identification plate	9-6		
Vehicle identification number (VIN) (chassis number)	9-7		

تلفن شبانه روزی: ۰۸۵۲۰۸۸۸۲۰۲۲۱
FarmaSOS.com

CAPACITIES AND RECOMMENDED FUEL/LUBRICANTS

The following values are approximate capacities. The actual refill capacities may be slightly different from them. When refilling, follow the procedure instructed in the "8. Maintenance and do-it-yourself" section to determine the proper refill capacity.

	Capacity (approximate)		Recommended specifications	
	Litre	Imp measure		
Fuel	55 or 65	12.1gal or 14-1/4 gal	See "Fuel information" later in this section.	
Engine oil (Refill)				
With oil filter replacement	HRA2DDT	4.63	4-1/8 qt	HRA2DDT engine: Genuine NISSAN engine oil 5W40 *1 ACEA A3/B4 *1
	MR20DD	4.4	3-7/8 qt	
	K9K	4.6*5	4 qt*5	MR20DD engine: Genuine NISSAN engine oil 5W40 *1 ACEA A3/B4 *1
	R9M	5.5	4-7/8 qt	
Without oil filter replacement	HRA2DDT	4.3	3-3/4 qt	Genuine NISSAN engine oil 5W30 DPF *1 ACEA C4 *1, SAE 5W30 Low SAPS
	MR20DD	4.2	3-3/4 qt	
	K9K	4.4 *5	3-7/8 qt *5	R9M engine: Genuine NISSAN engine oil 5W30 DPF *1 ACEA C4 *1, SAE 5W30 Low SAPS
	R9M	5.1	4-1/2 qt	
Engine coolant				
HRA2DDT	6.4	5-5/8 qt	Genuine NISSAN engine coolant or equivalent in its quality *2	
MR20DD	7.1	6-1/4 qt		
K9K	6.3	5-1/2 qt		
R9M	MT models	7.3		6-3/8 qt
	XTRONIC models	7.9		7 qt
Reservoir	Max level	0.57	4/7 qt	
Differential gear oil		0.55	1/2 qt	Genuine NISSAN Differential oil or API GL5. viscosity SAE 80W90
Transfer gear oil	MR20	0.33	3/8 qt	Genuine NISSAN Differential oil Hypoid Super GL-5 80W90 or PI GL5. viscosity SAE 80W90
	R9M	0.36	3/8 qt	

	Capacity (approximate)		Recommended specifications	
	Litre	Imp measure		
Manual transaxle gear oil	R9M 4WD	1.7	1-1/2 qt	NISSAN MT-XZ Gear Oil Sports and Off-Road Vehicles or API GL-4 Viscosity SAE 75W-85
	R9M 2WD	1.7	1-1/2 qt	
	K9K	2.0	1-3/4 qt	NISSAN MT-XZ Gear Oil TL/JR Type or API GL-4 Viscosity SAE 75W-80
	MR20 HRA2DDT			
XTRONIC Transmission (CVT) fluid	R9M with 2WD	-	-	Genuine NISSAN CVT fluid NS-3 *3 *4
	HRA2DDT with 2WD	-	-	
	MR20 with 2WD	-	-	
	MR20 with 4WD	-	-	
Brake & clutch fluid	Refill to the correct level according to the instructions in the "8. Maintenance and do-it-yourself" section.		Genuine NISSAN brake fluid or equivalent. DOT 4 (US FMVSS No. 116)	
Multi-purpose grease	-	-	NLGI No. 2 (Lithium soap base)	
Air conditioning system refrigerant	-	-	HFO-1234yf (for Europe) HFC-134a (R-134a) (except for Europe)	
Air conditioning system lubricants	-	-	ND-12 oil or equivalent (for Europe) ND-8 oil (Except for Europe)	

- *1: For further details, see "Recommended SAE viscosity number" later in this section.
- *2: Use Genuine NISSAN engine coolant, or equivalent in its quality, in order to avoid possible aluminium corrosion within the engine cooling system caused by the use of non-genuine engine coolant. **Note that any repairs for the incidents within the engine cooling system while using non-genuine engine coolant may not be covered by the warranty, even if such incidents occurred during the warranty period.** Contact a NISSAN dealer or qualified workshop for more information regarding the coolant type and capacity.
- *3: **Use only Genuine NISSAN CVT Fluid NS-3. Using transmission fluid other than Genuine NISSAN CVT Fluid NS-3 will damage the CVT, which is not covered by the warranty.**
- *4: Contact a NISSAN dealer or qualified workshop for details or servicing.
- *5: K9K engine with DPF.

FUEL INFORMATION

Petrol engine

CAUTION

Do not use leaded petrol. Using leaded petrol will damage the catalytic converter.

MR20DD engine:

Use UNLEADED REGULAR petrol with an octane rating of at least 91 (RON).

HRA2DDT engine:

Use UNLEADED PREMIUM petrol with an octane rating of at least 95 (RON).

Diesel engine

Diesel fuel above 51 cetane and with less than 10 ppm of sulphur (EN590 and Euro 5 specification) must be used.

If two types of diesel fuel are available, use summer or winter fuel properly according to the following temperature conditions.

- Above -7°C (20°F) . . . Summer type diesel fuel.
- Below -7°C (20°F) . . . Winter type diesel fuel.

If you are in any doubt, please consult a NISSAN dealer or qualified workshop.

CAUTION

- Do not use home heating oil, petrol or other alternate fuels in the diesel engine, this can cause engine damage.

- Do not add petrol or other alternate fuels to diesel fuel.
- Do not use summer fuel at temperatures below -7°C (20°F). Cold temperatures will cause wax to form in the fuel and may prevent the engine from running smoothly.

RECOMMENDED SAE VISCOSITY NUMBER

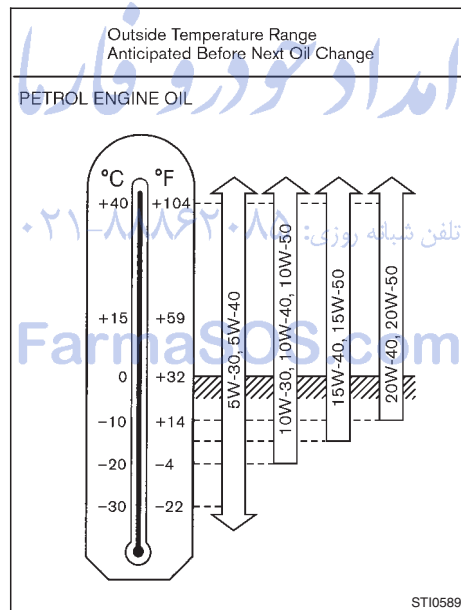

Petrol engine oil

Petrol engine oil

5W-40 is preferable. If 5W-40 is not available, select the viscosity from the chart, that is suitable for the outside temperature range.

Diesel engine oil

- **K9K engine with DPF:**

ONLY use 5W30 Low SAPS

- **R9M engine:**

ONLY use 5W30 DPF Low SAPS

ENGINE

Model	MR20DD	K9K	HRA2DDT	R9M
Type	Petrol, 4-cycle	Diesel, 4-cycle	Petrol, 4-cycle	Diesel, 4-cycle
Cylinder arrangement	4-cylinder in-line	4-cylinder in-line	4-cylinder in-line	4-cylinder in-line
Bore x Stroke	mm (in) 84 x 90.1 (3.31 x 3.55)	76.0 x 80.5 (2.992 x 3.169)	72.2 x 73.1 (2.84 x 2.88)	80 x 79.5 (3.15 x 3.13)
Displacement	cm ³ (cu in) 1,997 (121.86)	1,461 (89.15)	1,197 (73.0)	1,598 (97.51)
Idling speed	rpm	850 ± 50	*	850 ± 50
Ignition timing (BTDC)	degree	700 ± 50	—	—
Ignition timing position	MT XTRONIC in N	—	—	—
Ignition timing position	9 ± 5°	—	—	—
Spark plug	Standard PLZKAR6A-11	—	*	—
Spark plug gap	mm (in) 1.1 (0.043)	—	*	—
Camshaft operation	Timing chain	Timing belt	Timing chain	Timing chain

* Contact a NISSAN dealer or qualified workshop for details.

WHEELS AND TYRES

Unit: mm (in)		
Item	Size	Offset
Road wheel	Steel	16 x 6.5J
		16 x 4T *1
		17 x 7.0J
	Aluminium*	18 x 7.0J
		19 x 7.0J
Tyre size		215/65R16
	Conventional	215/60R17*
		215/55R18*
		225/45R19*
Spare	Conventional *	T145/90R16 *1

* : where fitted

*1: Temporary-use spare tyre (where fitted)

FarmaSOS.com

DIMENSIONS

		Unit: mm (in)
	Model	mm (in.)
Overall length	2WD/ 4WD	4379 (172.3)
Overall width	2WD/ 4WD	1806 (71.1)
Overall height	2WD	1590 (62.6)
	4WD	1595 (62.8)
	2WD	1624 (63.9)*1
	4WD	1630 (64.2)*1
Front tread	2WD/ 4WD	1560 (61.4)
Rear tread	2WD	1560 (61.4)
	2WD*2/4WD	1550 (61)
Wheelbase	2WD/ 4WD	2646 (104.2)

*1 : with roof rail

*2: models with Independent Multi-link type suspension (where fitted)

WHEN TRAVELLING OR TRANSFERRING YOUR REGISTRATION TO ANOTHER COUNTRY

When planning to travel in another country, you should first find out if the fuel available is suitable for your vehicle's engine.

Using fuel with too low octane/cetane rating may cause engine damage. Therefore, avoid taking your vehicle to areas where appropriate fuel is not available.

When transferring your vehicle registration to another country, check with the appropriate authorities that the vehicle complies with the requirements as it may not be possible to adapt it. In some cases, a vehicle cannot meet the legal requirements and in other cases, it may be necessary to modify the vehicle to meet specific laws and regulations.

The laws and regulations for motor vehicle emission control and safety standards vary according to the country; therefore, vehicle specifications may differ.

NISSAN is not responsible for any inconvenience when the vehicle is taken and registered into another country. The necessary modifications, transportation and registration are the owner's responsibility.

VEHICLE IDENTIFICATION

VEHICLE IDENTIFICATION PLATE

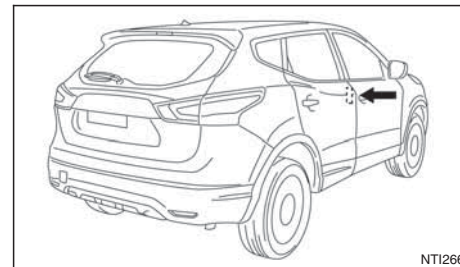

The plate is affixed on the B pillar as shown.

Built date

Built date is stamped on the vehicle identification plate or on a built date plate. The built date means the calendar month and the year in which the body shell and power train sub-assemblies are conjoined and the vehicle is driven or moved from the production line.

VEHICLE IDENTIFICATION NUMBER (VIN) (chassis number)

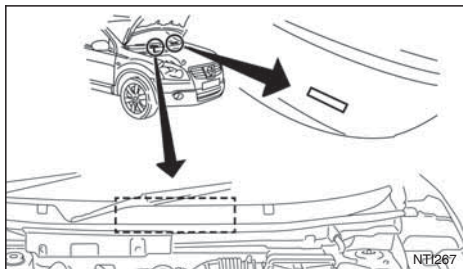

The VIN number is located as shown.

ENGINE SERIAL NUMBER

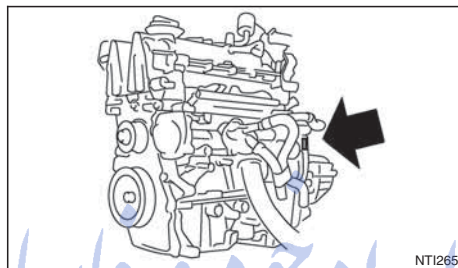

HRA2DDT engine

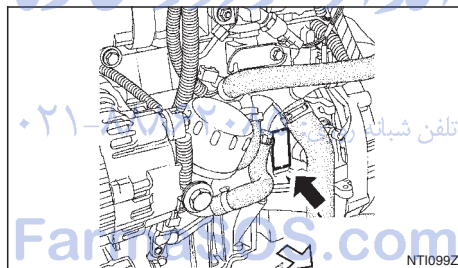

K9K engine

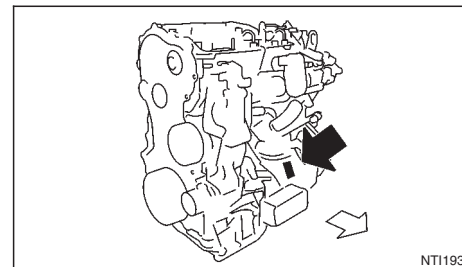

R9M engine

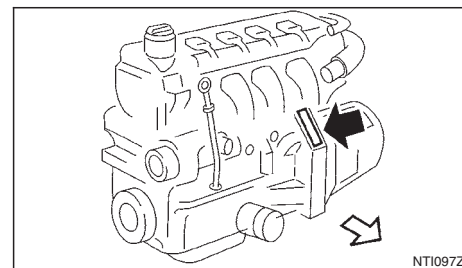

MR20DD engine

The number is stamped on the engine as shown.

APPROVAL NUMBERS

TYRE PLACARD

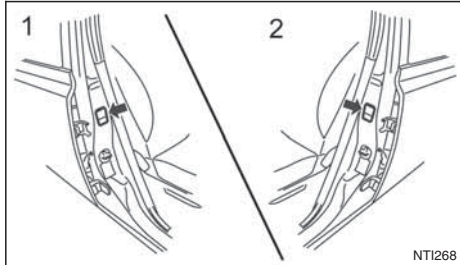

- 1 Right Hand Drive models
- 2 Left Hand Drive models

The cold tyre pressure is shown on the tyre placard fixed to the side of the driver's side centre pillar.

AIR CONDITIONER SPECIFICATION LABEL (where fitted)

Open the bonnet. The label is affixed at the front section of the bonnet.

All radio frequency or audio frequency products fitted to the NISSAN range during production conform to the requirements of the R&TTE Directive.

NISSAN ANTI-THEFT SYSTEM (NATS), INTELLIGENT OR REMOTE KEYLESS SYSTEM

Remote keyless entry system (where fitted)

Hereby, ALPS ELECTRIC CO.,LTD. declares that Keyless Transmitter, model TWB1G767 is in compliance with the essential requirements and other relevant provisions of Directive 1999/5/EC.

CAUTION

- Do not expose to excessive heat such as sunshine, fire or the like.
- Danger of explosion if battery is incorrectly replaced. Replace only with the same or equivalent type.

FarmasOS.com
CE

Intelligent Key system (where fitted)

- Intelligent Key (where fitted):
 - Manufacturer name:
Continental Automotive GmbH
 - Model name:
S180144104
- Alarm (Siren) system (where fitted):
 - 116RAI-002868
 - 116RI-002869

ALPS ALPS ELECTRIC CO., LTD. Engineering Headquarters
6-3-36, Nakazato, Funakawa, Osaka-city, 599-6486, Japan
Phone: +81 22-52-5011 Fax: +81 22-52-5019

**DECLARATION OF CONFORMITY
For**



Product: Remote Keyless Entry
(Hand Unit)
Model: TWB1G767
Type: Transmitter

Supplied by
ALPS ELECTRIC CO., LTD.
6-3-36, Nakazato, Funakawa, Osaka-city,
Miyagi-pref., JAPAN 989-6181

Technical Construction File held by
ALPS ELECTRIC CO., LTD.
6-3-36, Nakazato, Funakawa, Osaka-city,
Miyagi-pref., JAPAN 989-6181

Notified Body - R&TTE Directive N/A

Standard used for comply

R&TTE Directive (Article 3.1(a) Safety) EN 60965: 2002 + Amd.1: 2006 + Amd.11: 2008 + Amd.2: 2010 + Amd.12: 2011

R&TTE Directive (Article 3.1(b) EMC) EN 301 489-1 V1.9.2:2011-09
EN 301 489-3 V1.4.1:2008-08

R&TTE Directive (Article 3.2 Spectrum) EN 300 220-1 V2.4.1:2012-05
EN 300 220-2 V2.4.1:2012-05

Means of Conformity

We declare under our sole responsibility that the Product (s) is conformity with the essential requirements and other relevant requirements of the Radio and Telecommunication Terminal Equipment (R&TTE) Directive (1999/5/EC).

Date of issue: February 28, 2013

Signature of Responsible Person:

Toru Kinoshita
Group Manager
GROUP 2 ENGINEERING DEPT. NT1269



**TYRE PRESSURE MONITORING
SYSTEM (TPMS) (Transmitter)**

Hereby, Continental Automotive GmbH, declares that this S180052048/S180052050 is in compliance with the essential requirements and other relevant provisions of Directive 1999/5/EC

تلفن شبانه روزی: ۰۲۱-۸۸۶۶۲۰۸۵

FarmaSOS.com

Continental Interim

Generale Technisches Daten-Protokoll 1210 04 - 0208 Regensburg

Body & Security
Josef Lafer
185 POC Center 104
Phone +49 (0)41 750-8943
Fax +49 (0)41 75009-2842
joel@am@continental-corporation.com

Date: July 31, 2012 Your message about: For Reference: TG1C Nissan CMF1 Your address:

Declaration of Conformity

We, the undersigned, declare that

The tire pressure monitoring sensor S180052048 uses the same

- schematic,
- assembly
- and PCB

as the tire pressure monitoring sensor S180052050.

They only differ in:

- Protocol

The modification is necessary to adapt several carlines.

This modification does not influence the RF characteristics of the system.

Yours truly,

Continental Automotive GmbH
Regensburg, 31.07.2012

Andreas Wolf
Executive Vice President
Body & Security

Norbert Müller
Director Product Group 1
Body & Security

Technisches Approbations-Daten-Protokoll 1210 04 - 0208 Regensburg
Generale Technisches Daten-Protokoll 1210 04 - 0208 Regensburg
Kontakt-Informationen
Kontakt-Informationen

Phone +49 041 750-0
Fax +49 041 750-2000
www.continental-corporation.com
E-Mail: am@continental-corporation.com

Regensburg (041) 750-0
Regensburg (041) 750-2000
Regensburg (041) 750-2000
Regensburg (041) 750-2000

NT1250

**NISSAN Anti-Theft System (NATS)
immobilizer**

Hereby, Continental Automotive GmbH declares that this ANT ASSY-IMMOBILISER model S180192102 is in compliance with the essential requirements and other relevant provisions of Directive 1999/5/EC.

	
Continental Automotive Group - Postfach 10 010 - 83020 Regensburg	
Josef Lohr I BS P03 CFFW VMS Phone +49 (0)41 750-0942 Fax +49 (0)41 750-99942 josef.lohr@continental-corporation.com	
Date:	Your company name:
April 16, 2012	TO1C Volvo
Declaration of Conformity in accordance with Directive 1999/5/EC (R&TTE Directive)	
Manufacturer:	Continental Automotive GmbH
Address:	Sonnenrasse 12 D-93055 Regensburg Germany
Product type designation:	S1800S2050
Intended use:	Tire Pressure Monitoring Sensor
The product mentioned above complies with the essential requirements and other relevant provisions of Directive 1999/5/EC when used for its intended purpose.	
Health and safety pursuant to Art. 3(1)(a):	Applied standard(s): EN 60 820-1:2008 + A11:2009 + A12:2010 + A13:2011 EN 62 478:2010
Electromagnetic compatibility pursuant to Art. 3(1)(b):	Applied standard(s): EN 301 488-1 V1.6.1 (2008-04) EN 301 489-3 V1.4.1 (2002-08)
Efficient use of spectrum pursuant to Art. 3(2):	Applied standard(s): EN 300 220-1 V2.3.1 (2010-02) EN 300 220-2 V2.3.1 (2010-02)
The following marking applies to the above mentioned product:	
	
Continental Automotive GmbH Regensburg, 2012-04-16	
 Andreas West Executive Vice President Body & Security	 Norbert Müller Director Product Group 1 Body & Security
Continental Automotive Group Postfach 10 010 D-83020 Regensburg	Phone +49 (0)41 750-0 Fax +49 (0)41 750-99942 www.continental-corporation.com
Registered Office: Regensburg, Germany HRB 15093 USt-IdNr.: DE255150933	Tax ID No.: DE255150933 VAT No.: DE255150933

NT1251

امداد خودرو فارما

تلفن شبانه روزی: ۰۲۱-۸۸۸۶۲۰۸۵

FarmaSOS.com

NOTE

امداد خودرو فارما

تلفن شبانه روزی: ۰۲۱-۸۸۸۶۲۰۸۵

FarmaSOS.com

NOTE

امداد خودرو فارما

تلفن شبانه روزی: ۰۲۱-۸۸۸۶۲۰۸۵

FarmaSOS.com

امداد خودرو فارما

تلفن شبانه روزی: ۰۲۱-۸۸۸۶۲۰۸۵

FarmaSOS.com

NOTE

امداد خودرو فارما

تلفن شبانه روزی: ۰۲۱-۸۸۸۶۲۰۸۵

FarmaSOS.com

امداد خودرو فارما

تلفن شبانه روزی: ۰۲۱-۸۸۸۶۲۰۸۵

FarmaSOS.com

NOTE

امداد خودرو فارما

تلفن شبانه روزی: ۰۲۱-۸۸۸۶۲۰۸۵

FarmaSOS.com

10 Index

A

Active engine brake	5-63
Active ride control	5-64
Active trace control	5-62
Air cleaner filter	8-23
Air conditioner	
– Air conditioner filter	4-19, 4-22
– Air conditioner specification label	9-8
– Automatic air conditioner	4-20
– Heater and air conditioner	4-15
– Manual air conditioner	4-16
– Servicing air conditioner	4-19, 4-22
Air duct removal	8-21
Alarm system	3-12
Antenna	4-23
Anti-hijack – unlock mode	3-5
Anti-Lock Braking System (ABS)	5-59
Anti-Theft System (NISSAN)	3-13
Approval numbers	9-8
Armrest	1-5
Around View Monitor	4-4
– Around View Monitor settings	4-13
– Moving object detection (MOD)	4-12
– Operating tips	4-13
Around view monitor operation	4-7
Audible reminders, warning/indicator lights	2-4
Audio	
– Audio operation precautions	4-23
– Audio system	4-23
– AUX socket	4-30

B

– Bluetooth® audio streaming main operation	4-34
– FM AM radio with CD player	4-24
– iPod® player operation	4-31
– NissanConnect	4-38
– Steering-wheel switch for audio control	4-38
– USB Memory operation	4-30
Battery	5-66, 8-16
– Caution label	8-16
– Integrated keyfob battery replacement	8-18
– Intelligent Key battery discharge	5-14
– Intelligent Key battery replacement	8-18
– Vehicle battery	8-16
Before starting the engine	5-2
Blind Spot Warning (BSW)	
– BSW driving situations	5-32
– BSW system operation	5-30
Blind Spot Warning (BSW) system	5-30
Bluetooth®	4-39
– Bluetooth® mobile phone feature	4-39
– Bluetooth® operation	4-32
– Bluetooth® settings	4-32
Bonnet release	3-14
Boot	2-47
Brake	8-13
– Brake booster	8-14
– Brake fluid	8-14
– Brake precautions	5-58
– Brake system	5-58

- Checking brake pedal	8-13
- Checking parking brake	8-13
- Parking brake	3-16
- Trailer brakes	5-55

C

Cable slots	2-43
Capacities and recommended fuel/lubricants	9-2
- Fuel information	9-4
Car phone or CB radio	4-45
Care when driving	5-10
Cargo compartment	
- Cargo floor	2-47
CENTRE mark on rear centre seat	1-12
Changing	
- Changing engine coolant	8-6
- Changing engine oil	8-9
- Changing engine oil filter	8-10
- Changing tyres and wheels	8-35
Chassis control	5-62
Checking	
- Checking brake pedal	8-13
- Checking engine coolant level	8-6
- Checking engine oil level	8-8
- Checking parking brake	8-13
Child restraint anchorage	1-22
Child restraint and ISOFIX information	1-16
Child restraint installation using 3-point type seat belt	1-25
Child restraint installation using ISOFIX	1-23
Child restraint systems (CRS)	
- ISOFIX	1-17
- Recommended	1-17
- Suitable	1-17
Child restraints	1-15

Child safety	1-14, 1-9
--------------------	-----------

Cleaning

- Alloy wheels	7-3
- Chrome parts	7-3
- Exterior	7-2
- Glass	7-3, 7-5
- Interior	7-4
- Plastic parts	7-5
- Rear-view camera lens	7-3
- Removing spots	7-2
- Underbody	7-3
Clutch fluid	8-14
Coat hooks	2-44
Cold weather driving	5-66
Console box	2-43
Continuously variable transmission	
- Continuously variable transmission fluid	8-13
- Driving with continuously variable transmission	5-18
Coolant	
- Changing engine coolant	8-6
- Checking engine coolant level	8-6
- Engine coolant	5-66
- Engine coolant temperature gauge	2-3
- Engine cooling system	8-6
Corrosion protection	5-67, 7-5
- Environmental factors	7-5
Cruise control	5-36
Cruise control system operations	5-37
CVT	
- Driving with XTRONIC transmission	5-18

D

Defogger switch

- Outside mirror defogger	2-35
- Rear window defogger	2-35

Difference between predictive and actual distances	4-9
Dimensions	9-6
Door locks	3-8
– Back door	3-11
– Child safety rear door locks	3-11
– Locking/unlocking with the key — vehicle dead battery	3-9
– Power door lock switch	3-10
– Remote keyless entry system	3-4
– Super Lock system	3-8
– When leaving the vehicle	3-10
Drive belts	8-20
Driving	
– Care when driving	5-10
– Cold weather driving	5-66
– Driving four-wheel drive (4WD) safely	5-28
– Driving on wet road	5-10
– Driving the vehicle	5-17
– Driving under winter conditions	5-10
– Driving with manual transmission	5-17
– On-pavement and off-road driving precautions	5-9
– Precautions when starting and driving	5-3
– Stop/Start System	5-22

E

ECO mode system	5-65
Electric power steering system	5-57
Electronic Stability Programme (ESP) system	5-60
– ESP OFF switch	5-61
Emergency tyre puncture repair kit	6-8, 8-36
Emergency/mechanical key	3-3
Engine	
– Before starting the engine	5-2
– Changing engine coolant	8-6
– Changing engine oil	8-9
– Changing engine oil filter	8-10

– Checking engine coolant level	8-6
– Checking engine oil level	8-8
– Data	9-5
– Engine cold start period	5-10
– Engine compartment	0-11, 8-5
– Engine coolant	5-66
– Engine coolant temperature gauge	2-3
– Engine cooling system	8-6
– Engine oil	8-8
– Engine overheat	6-13
– Engine serial number	9-7
– Fuel filter (Diesel engine models)	8-13
– Starting engine	5-15
Exhaust gas (Carbon Monoxide)	5-3
Exterior lights	8-29

F

Filter	
– Air cleaner filter	8-23
– Air conditioner filter	4-19, 4-22
– Fuel filter (Diesel engine models)	8-13
Floor mats	7-4
Fluid	
– Brake and clutch fluid	8-14
– Continuously variable transmission fluid	8-13
– Window washer/headlight cleaner fluid	8-15
Fog light	
– Front fog light	2-38
– Rear fog light	2-39
Forward emergency braking system	5-40
Four-wheel drive (4WD)	5-26
– Driving four-wheel drive (4WD) safely	5-28
– Four-wheel drive (4WD) model (Tyres)	8-35
– Four-wheel drive mode indicator light	5-28

Fuel	
- Bleeding the fuel system	8-13
- Capacities and recommended fuel/lubricants	9-2
- Draining water (Fuel filter)	8-13
- Fuel filter (Diesel engine models)	8-13
- Fuel gauge	2-2
- Fuel information	9-4
Fuel filler lid	
- Cap	3-15
- Opener lever	3-15
Fuses	8-25
- Engine compartment	8-26
- Passenger compartment	8-25

G

Gauges	
- Engine coolant temperature gauge	2-3
- Fuel gauge	2-2
- Meters and gauges	2-2
Glass roof	2-49
- Sunshade operation	2-50
Glove box	2-42
Guide lines	4-7

H

Hazard warning flasher switch	6-2
Head restraint	
- Adjustment	1-6
Headlight	
- Headlight aiming control switch	2-39
- Headlight and turn signal switch	2-36
- Headlight cleaner	2-40
- Headlight switch	2-36

- Headlights (bulb replacement)	8-28
- Replacement (bulb)	8-28
- Turn signal switch	2-38
Heated seats	2-41
Heater and air conditioner	4-15
Hill Start Assist (HSA) system	5-64
Horn	2-41
How to adjust the screen view	4-13

I

Ignition	
- Ignition switch	5-11
Ignition switch	5-12
Ignition switch positions	5-13
Immobilizer	
- NISSAN Anti-Theft System (NATS)	3-12
Indicator lights	2-4
Injured persons	1-10
Inside rear-view mirror	3-18
Instrument and control layout	0-8, 0-9
Integrated keyfob (remote control system)	3-4
- Battery replacement	8-18
- Ignition switch	5-11
- Keyfob operation failure	3-5
- Locking the doors	3-5
- Setting the unlock mode	3-5
- Super Lock system	3-5
- Unlocking the doors	3-5
Intelligent Key operating range	3-6
Intelligent Key system	3-6, 5-12
- Anti-hijack mode	3-7
- Battery replacement	8-18
- Intelligent Key battery discharge	5-14
- Locking/unlocking	3-7

- Starting the engine	3-8
Intelligent Parking Assist (IPA)	5-46
Interior lights	2-50, 8-29
iPod® player operation	4-31
ISOFIX	1-19
ISOFIX child restraint system	1-21

J

Jump-starting	6-11, 8-18
---------------------	------------

K

Key	3-2
- Immobilizer	3-2
- Integrated keyfob (remote control system)	3-4
- Intelligent Key battery discharge	5-14
- Intelligent Key operating range	3-6
- Intelligent Key system	3-6, 5-12
- Key positions (Ignition switch)	5-11
- NISSAN Anti-Theft System (NATS)	3-2
- NISSAN Anti-Theft System (NATS) key	3-2
- Radio approval number and information	9-8
- Remote keyless entry system	3-4
- Using Intelligent Key system	3-6

L

Lane Departure Warning (LDW)	5-33
- LDW system operation	5-34
Legal requirements	1-15
Light	
- Exterior lights	8-29
- Fog light switch	2-38

- Hazard warning flasher switch	6-2
- Headlight aiming control switch	2-39
- Headlight and turn signal switch	2-36
- Headlight cleaner	2-40
- Headlight switch	2-36
- Headlights	8-28
- Interior lights	2-50, 8-29
- LED headlight	8-28
- Light locations	8-30
- Luggage compartment	2-51
- Map lights	2-50
- Rear room/reading light	2-51
- Trailer direction indicator light	5-56
- Turn signal switch	2-38
- Warning/indicator lights and audible reminders	2-4

Lock

- Anti-Lock Braking System (ABS)	5-59
- Back door lock	3-11
- Child safety rear door locks	3-11
- Door locks	3-8
- Power door lock switch	3-10
- Steering lock	5-11, 5-14
- Super Lock system	3-8
- Unlocking with inside door handle	3-10

Luggage compartment

- Luggage floor	2-47
-----------------------	------

M

Maintenance

- Camera unit maintenance	5-33
- General maintenance	8-2
- Maintenance precautions	8-4
- Maintenance requirements	8-2
- Multi-sensing camera unit	5-35

Manual transmission

- Driving with manual transmission	5-17
--	------

Map lights	2-50
Maximum load limits (for Australia)	5-55
Mechanical/emergency key	3-3
Meter and gauges	
– Engine coolant temperature gauge	2-3
– Fuel gauge	2-2
– Speedometer	2-2
– Tachometer	2-2
Meters and gauges	2-2
Mirror	3-18
– Automatic anti-dazzling inside mirror	3-19, 7-5
– Inside rear-view mirror	3-18
– Outside rear-view mirrors	3-19
– Vanity mirror	3-20
Mobile phone integration for FM AM radio with CD player ...	4-39
Monitor display	
– Monitor display's maintenance	7-4
– Rear-view monitor	4-2
Moving object detection (MOD)	4-12

N

NISSAN Anti-Theft System (NATS)	3-2, 5-12
– NATS key	3-2
– NATS security indicator light	3-13
– Radio approval number and information	9-8

O

Odometer/twin trip odometer	2-2
Oil	
– Changing engine oil	8-9
– Changing engine oil filter	8-10
– Checking engine oil level	8-8
– Engine oil	8-8

– Recommended lubricants	9-2
– Recommended SAE viscosity number	9-4
On-pavement and off-road driving precautions	5-9
Overheat	
– Engine overheat	6-13

P

Parcel shelf	
– Installation	2-45
– Removal	2-45
Parking	5-43
– Ultrasonic parking sensors	5-45
Parking brake switch	3-16
Phone	
– Bluetooth®	4-39
– Mobile phone integration for FM AM radio with CD player	4-39
Power	
– Electric power steering system	5-57
– Power door lock switch	3-10
– Power outlet	2-42
Pre-tensioner seat belt system	1-13
Precautions	
– Audio operation precautions	4-23
– Brake precautions	5-58
– Cruise control precautions	5-36
– Maintenance precautions	8-4
– On-pavement and off-road driving precautions	5-9
– Operating precautions (trailer)	5-54
– Precautions on push-button ignition switch operation	5-12
– Precautions on Supplemental Restraint System	1-29
– Safety precautions	4-2
– Towing precautions	6-14
– When starting and driving	5-3
Precautions on child restraints	1-15

Predictive course lines	
– Around View Monitor settings	4-13
Pregnant women	1-10
Protect	
– Protect the environment	8-12
– Protect your vehicle from corrosion	7-6
Push-button ignition switch	5-12
Push-starting	6-13

R

Radio	
– FM AM radio with CD player	4-24
– NissanConnect	4-38
Rear parcel shelf	2-45
Rear seat	1-5
Rear window defogger	2-35
Rear-view monitor	4-2
– Operating tips	4-3
– Rear-view monitor setting	4-3
Recommended SAE viscosity number	9-4
Remote control system (integrated keyfob)	3-4
Repair and replacement procedure	1-37
Repairing flat tyre	6-8
Roof	
– glass	2-49
Roof rail	2-45
Room light control switch	2-50
Running-in schedule	5-2

S

Safety	
– Child safety	1-9

– Child safety rear door locks	3-11
– Head restraints adjustment	1-6
– Safety chains (Trailer)	5-55
Seat	
– Armrest	1-5
– CENTRE mark on rear centre seat	1-12
– Child restraint installation using 3-point type seat belt	1-25
– Front seats – Adjustment	1-3
– Head restraints adjustment	1-6
– Rear seat	1-5
– Seat heater	1-4
– Seat heating	2-41
– Seats	1-2
– Three-point type seat belts	1-11
– Universal child restraints for front seat and rear seats	1-16
Seat belt	
– CENTRE mark on rear centre seat	1-12
– Child safety	1-9
– Pre-tensioner seat belt system	1-13
– Seat belt warning	1-10
– Seat belt warning light	2-4
– Seat belts	1-8, 7-5
Seat belt(s)	
– Child restraint installation using 3-point type seat belt	1-25
– Child safety	1-14
– Infants	1-14
– Larger children	1-14
– Seat belt maintenance	1-12
– Shoulder belt height adjustment	1-12
– Small children	1-14
– Three-point type seat belts	1-11
Security system	3-12
– Alarm system	3-12
– NISSAN Anti-Theft System (NATS)	3-12, 3-13, 3-2
Servicing air conditioner	4-19, 4-22
Shoulder belt height adjustment (for front seats)	1-12
Snow chains	8-34

Spare tyre	6-2	Super Lock system	3-8
Spark plugs (Petrol engine models)	8-21	– Emergency situations	3-9
Speed limiter	5-38	– Power door lock switch	3-11
Speed limiter operations	5-39	Supplemental Restraint System	1-29
Speedometer	2-2	Supplemental Restraint System (air bag system)	
Starting		– Air bag system	1-29
– Before starting the engine	5-2	Switch	
– Jump-starting	6-11, 8-18	– Defogger switch	2-35
– Precautions when starting and driving	5-3	– Fog light switch	2-38
– Push-starting	6-13	– Front passenger air bag switch	1-34
– Starting engine	5-15	– Headlight and turn signal switch	2-36
Steering		– Headlight cleaner switch	2-40
– Electric power steering system	5-57	– Ignition switch positions	5-13
– Phone operating buttons	4-44	– Ignition switch push button	5-12
– Steering lock	5-11, 5-14	– Power door lock switch	3-10
– Steering wheel adjustment	3-18	– Precautions on push-button ignition switch operation	5-12
– Steering wheel switches for hands-free telephone control	4-44	– Push-button ignition switch	5-12
– Steering-wheel switch for audio control	4-38	– Room light control switch	2-50
– Telephone button	4-39	– Wiper and washer switch	2-32
Stop/Start System	5-22	Switch - Defogger switch	
Storage	2-42	– ThermoClear	2-34
– Bottle holder	2-44	System operation	5-41
– Coat hooks	2-44		
– Console box	2-43		
– Cup holder	2-44		
– Glove box	2-42		
– Luggage hooks	2-47		
– Luggage/boot compartment	2-47		
– Map pockets	2-44		
– Roof rail	2-45		
– Seat pockets	2-44		
– Storage trays	2-42		
– Sunglasses holder	2-43		
Sun visors	3-18		
Sunshade			
– Sunshade operation	2-50		

	T
--	----------

Tachometer	2-2
Temporary-use spare tyre	6-2
ThermoClear Heated Windscreen	
– ThermoClear Heated Windscreen button	2-34
Three-point type seat belts	1-11
Three-way catalyst (Petrol engine models)	5-9
Tilting steering wheel	3-18
Towing	
– Recommended towing for four-wheel drive (4WD) models	6-15

- Recommended towing for two-wheel drive (2WD) models	6-15
- Tow bar Installation	5-56
- Tow truck towing	6-14
- Towing eye	6-16
- Towing precautions	6-14
- Trailer towing	5-54
Trailer	
- Trailer brakes	5-55
- Trailer detection	5-56
- Trailer direction indicator light	2-12
- Trailer towing	5-54
Transmission	
- Continuously variable transmission fluid	8-13
- Driving with manual transmission	5-17
- Manual transmission (ignition switch)	5-11
- XTRONIC (ignition switch)	5-11
Travelling or transferring your registration to another country ..	9-6
Trip computer	2-27
Turbocharger system (Diesel engine models)	5-10
Turn signal switch	2-38
Tyre	
- Changing tyres and wheels	8-35
- Emergency tyre puncture repair kit	6-8, 8-36
- Flat tyre	6-3
- Repairing flat tyre	6-8
- Spare tyre	8-36
- Temporary-use spare tyre	6-2
- Types of tyres	8-33
- Tyre age	8-35
- Tyre equipment	5-66
- Tyre inflation pressure	8-33
- Tyre placard	9-8
- Tyre pressure (Trailer)	5-55
- Tyre Pressure Monitoring System (TPMS)	6-7
- Tyre rotation	8-34
- Tyre wear and damage	8-35

- Wheels and tyres	8-33, 9-5
Tyre Pressure Monitoring System (TPMS)	5-4

U

Ultrasonic sensor	
- Alarm sensor	3-12
- Parking sensor	5-45
Universal child restraints for front seat and rear seats	1-16
USB Memory operation	4-30
Using Intelligent Key system	3-6

V

Vehicle identification	9-6
- Vehicle identification number (VIN) (chassis number)	9-7
- Vehicle identification plate	9-6
Vehicle information display	2-13
Vehicle information display warnings and indicators	2-21
Vehicle security	3-12, 5-57
- Alarm system	3-12
Vents	4-14

W

Warning/indicator lights and audible reminders	2-4
Washing	7-2
Waxing	7-2
Wheel	
- Blocking the wheels	6-3
- Care of wheels	7-3
- Changing tyres and wheels	8-35
- Getting the tools and spare wheel	6-3
- Installing the wheel	6-5

- Removing the wheel	6-4
- Removing the wheel cover	6-4
- Stowing the wheel and tools	6-6
- Wheel balance	8-36
- Wheel lock bolts	6-4, 6-6
- Wheel lock key code	6-6
- Wheels and tyres	8-33, 9-5
Wheel lock bolts	6-6
Windows	2-48
- Auto-reverse function	2-48
- Automatic function	2-48
- Locking passengers' windows	2-48
- Power windows	2-48
- Reinitialisation procedure after battery reconnection	2-49
- Window reinitialisation procedure after battery reconnection	2-49
Winter (Special winter equipment)	5-67
Wiper	
- Back door window wiper replacement	8-24
- Front window wiper replacement	8-24
- Rain sensor	2-33
- Rear window wiper and washer switch	2-33
- Washer nozzle	8-25
- Window washer/headlight cleaner fluid	8-15
- Windscreen wiper and washer switch	2-32
- Wiper blades replacement	8-24

X

XTRONIC transmission

- Continuously variable transmission fluid	8-13
- Driving with XTRONIC transmission	5-18

PETROL STATION INFORMATION

FUEL INFORMATION

Petrol engine

CAUTION

Do not use leaded petrol. Using leaded petrol will damage the catalytic converter.

MR20DD engine:

Use UNLEADED REGULAR petrol with an octane rating of at least 91 (RON).

HRA2DDT engine:

Use UNLEADED PREMIUM petrol with an octane rating of at least 95 (RON).

For further details, see "Fuel information" in the "9. Technical information" section.

Diesel engine

Diesel fuel above 51 cetane and with less than 10 ppm of sulphur (EN590 and Euro 5 specification) must be used.

For further details, see "Fuel information" in the "9. Technical information" section.

CAUTION

- **Do not use home heating oil, petrol or other alternate fuels in the diesel engine, this can cause engine damage.**
- **Do not add petrol or other alternate fuels to diesel fuel.**

- **Do not use summer fuel at temperatures below -7°C (20°F). Cold temperatures will cause wax to form in the fuel and may prevent the engine from running smoothly.**

RECOMMENDED ENGINE OIL *

HRA2DDT engine

- Genuine NISSAN engine oil 5W40
- ACEA A3/B4

MR20DD engine

- Genuine NISSAN engine oil 5W40
- ACEA A3/B4

K9K engine

- Genuine NISSAN engine oil 5W30 DPF
- ACEA C4, SAE 5W30 low SAPS تلفن شیبانه

R9M engine

- Genuine NISSAN engine oil 5W30 DPF
- ACEA C4, SAE 5W30 low SAPS

* For further details, see "Capacities and recommended fuel/lubricants" in the "9. Technical information" section.

COLD TYRE PRESSURE

See the tyre placard affixed to the driver's side centre pillar.

ENVIRONMENT (End of Life Vehicles)

ENVIRONMENTAL CONCERN



BLUE CITIZENSHIP

Today, the efforts made by NISSAN to fulfil our responsibilities to protect and sustain the environment are far-reaching. Within NISSAN, we promote the highest levels of practice in every region and in every area of operations.

COMPLIANCE AT EVERY STEP

NISSAN focuses on ensuring that end of life vehicle components are reused, recycled or recovered, and guarantees compliance with EU legislation (the End of Life Vehicle Directive).

WE BUILD OUR VEHICLES WITH RECYCLING IN MIND

Reducing landfill waste, emissions, conserving natural resources, and enhancing recycling activities are emphasised daily in our manufacturing, sales and service operations and in the disposal of end of life vehicles (ELV).

Design phase

To reduce environmental impact we have developed your NISSAN vehicle to be 95% recoverable. We mark the components to facilitate dismantling, recycling and to reduce hazardous substances. We carefully verify and control substances of concern. We have already reduced to a minimum the cadmium, mercury and lead in your NISSAN vehicle. NISSAN includes recycled material in your vehicle and looks for opportunities to increase the percentage of recycled materials used.

Manufacturing phase

NISSAN plants based in the UK and Spain already achieve a recycling rate of over 90% and are looking for further improvements. The UK plant installed 10 wind turbines to cut carbon dioxide emissions at power plants by more than 3,000 tonnes per year. NMISA (Spain) uses a solar panel water heating system to save energy. This will generate 33% of the energy consumed in the baths during the painting of your vehicle.

Production and distribution phase

Using resources efficiently to reduce the amount of waste generated during the production and distribution stage. NISSAN promotes activities based on Reducing, Reusing, and Recycling materials whenever possible. NISSAN's goal is to achieve a 100% recycling rate for operations in Japan and globally.

Use and service phase

NISSAN dealers are our window to you, our customer. In order to meet your expectations they provide not only high quality services but are also environmentally responsible. NISSAN promotes activities to recycle the waste generated as a result of service centre activities.

Disposal phase

Recycle your end of life vehicle or its components. When your NISSAN reaches the end of its life, and is no longer suitable for daily use, it still has value. You can help prevent waste affecting the environment by bringing your NISSAN to be recycled at our

collection networks in your area. Our collection networks guarantee no cost for the treatment of your ELV. For further information on how and where to dispose of your ELV refer to your local NISSAN dealer or consult: www.nissan-europe.com or consult: www.nissan-global.com.

PROTECT THE ENVIRONMENT WHEN DRIVING

Your driving behaviour has significant impact on fuel economy and the environment. Follow the tips below for better fuel-efficiency, better driving habits, and to be environmentally friendly by reducing emissions:

Fuel efficient driving

Anticipating traffic conditions and acting accordingly reduces fuel consumption, helping to protect our natural environment. Take your foot off the accelerator while approaching traffic lights and avoid last minute braking when the light turns red.

Avoid speeding, harsh acceleration, and strong braking. The gain in time does not offset pollution of the environment. Try to maintain speed when driving uphill to reduce fuel consumption and pollution. Maintain speed or allow the vehicle to go slower where traffic allows.

Close windows when driving

Driving with a window open at 100 km/h (62 MPH) increases fuel consumption by up to 4%. Driving with the windows closed allows for better fuel economy.

Use the roof rack only when necessary

Only install the roof luggage system when you really need it, otherwise put it inside the vehicle or store it in your garage. Do not drive around with an empty roof rack, kayak holder, or ski rack, this will reduce your aerodynamic drag significantly.

Optimise the use of air conditioning

The air conditioning system has a positive effect on driving and vehicle safety through comfort cooling and dehumidifying, drivers are more alert and have better visibility when window demisting/defogging becomes necessary. However, use of the air conditioning system will increase fuel consumption substantially in an urban environment. Optimise the use of air conditioning by using the vents as much as possible.

Use the parking brake on slopes

Use the parking brake when holding your vehicle on a slope. Avoid using the clutch (manual transmission) or the accelerator (continuously variable transmission) to hold your vehicle as this leads to unnecessary fuel consumption and wear.

Maintain a safe distance

Anticipate traffic conditions for a smoother drive and to assure comfort and safety during your trip. Drive and maintain a safe distance from other vehicles while in traffic. This will help reduce fuel consumption as you will not be constantly tapping your brakes.

Check your tyre pressure

Low tyre pressure increases fuel consumption as well as the use of non-recommended tyres. Correct tyre pressure will maximise the grip of your vehicle and optimise fuel consumption.

Have your car serviced regularly

Regular service allows you to run your vehicle in optimal condition and with the best fuel efficiency. Have your vehicle serviced by your NISSAN dealer or a qualified workshop to ensure that it is maintained to its original standard.

امداد خودرو فارما

تلفن شبانه روزی: ۰۲۱-۸۸۸۶۲۰۸۵

FarmaSOS.com

AIRBAG LABEL (where fitted)



NEVER use a rearward facing child restraint on a seat protected by an ACTIVE AIRBAG in front of it, DEATH or SERIOUS INJURY to the CHILD can occur.

NE JAMAIS utiliser un dispositif de retenue pour enfant de type dos à la route sur un siège protégé par un AIRBAG ACTIVÉ placé devant lui. Cela peut entraîner la MORT de l'ENFANT ou des BLESSURES GRAVES.

Installieren Sie niemals ein entgegen der Fahrtrichtung angeordnetes Kinderrückhaltesystem auf einem Sitz mit aktiviertem Frontairbag. Es könnte zum Tod oder schweren Verletzungen des Kindes führen.

No instalar nunca los sistemas de retención para niños (sillitas de niño) de espaldas al sentido de la marcha en el asiento del pasajero protegido por un AIRBAG frontal ACTIVO. Esto puede provocar la MUERTE del niño o DAÑARLE SERIAMENTE.

«NON INSTALLARE MAI un seggiolino per bambini rivolto con verso opposto al senso di marcia su un sedile protetto da un AIRBAG frontale ATTIVO. In caso di incidente questo potrebbe risultare molto pericoloso per l'incolumità del bambino.»

Plaats nooit een kinderzitje achterstevoren op de passagiersstoel voorin als de airbags van de voorpassagier niet zijn uitgeschakeld. Dit kan ernstige of zelfs dodelijke verwondingen van het kind veroorzaken.

NUNCA utilize um sistema de retenção de criança virado para a traseira num banco protegido por um AIRBAG ACTIVO à sua frente, porque pode ocorrer MORTE ou FERIMENTOS GRAVES na CRIANÇA.

W żadnym przypadku NIE NALEŻY stosować fotelików dla dzieci skierowanych tyłem do tyłu przed siedzeniami chronionymi AKTYWNA PODUSZKĄ POWIETRZNA. Może to doprowadzić do POWAŻNYCH OBRAŻEŃ lub nawet ŚMIERCI DZIECKA.

NIKDY nepoužívejte dětskou sedačku směřující dozadu na sedadle s AKTIVNÍM čelním AIRBAGEM, mohlo by dojít k USMRČENÍ nebo VÁŽNĚMU ZRANĚNÍ DÍTĚTE.

Önünde AKTİF BİR HAVA YASTIĞI ile korununan bir koltuğa hiç bir zaman yüzü geriye bakan bir çocuk koltuğu KOYMAYIN, bu ÇOCUĞUN ÖLÜMÜNE veya CİDDİ ŞEKİLDE YARALANMASINA neden olabilir.

Nu folosiți NICIODATĂ un scaun pentru copil cu spatele la direcția de deplasare pe un scaun protejat de un AIRBAG ACTIV amplasat în fața sa, deoarece există riscul de DECES sau RĂNIRE GRAVĂ a copilului.

SOHA ne használjon hátrafelé néző gyermekülést olyan ülésen, amelyet előlről AKTÍV LÉGZSÁK véd, mert az a GYERMEK HALÁLÁT vagy SÚLYOS SÉRÜLÉSÉT okozhatja.

“ΑΠΑΓΟΡΕΥΕΤΑΙ η τοποθέτηση παιδικού καθίσματος, με την πλάτη προς το εμπρόσθιο μέρος του αυτοκινήτου, στο κάθισμα του συνοδηγού, επειδή μπροστά του υπάρχει ΕΝΕΡΓΟΣ ΜΕΤΩΠΙΚΟΣ ΑΕΡΟΣΑΚΟΣ. Μπορεί να επέλθει, ΘΑΝΑΤΟΣ ή ΣΟΒΑΡΟΣ ΤΡΑΥΜΑΤΙΣΜΟΣ του ΠΑΙΔΙΟΥ”.

Använd ALDRIG en bakåtvänd barnstol på ett säte som skyddas av en AKTIVERAD AIRBAG framför det; LIVSFARA eller risk för ALLVARLIGA SKADOR.

ÄLÄ KOSKAAN käyttää kasvot taaksepäin suunnattua lastenistuinta istuimella, jossa on KÄYTÖSSÄ OLEVA TURVATYYNY. Seurauksena voi olla KUOLEMA tai LAPSEN VAKAVA LOUKKAANTUMINEN.

Brug ALDRIG et bagudvendt barnesæde på et sæde, der er beskyttet af en AKTIV AIRBAG foran det. Det kan resultere i DØD eller ALVORLIG PERSONSKADE på BARNET.



NEMOJTE upotrebljavati sjedalicu za djecu okrenutu prema natrag na sjedalu ispred kojega se nalazi zaštićeni AKTIVNI ZRAČNI JASTUK, može doći do SMRTONOSNIH ili OZBILJNIH OZLJEDA za DIJETE.

NIKOLI ne namestite otroškoga sedježa, obrnjenega v nasprotni smeri smeri vožnje, v primeru VKLOPLJENE varnostne blazine. To lahko povzroči OTROKOVO SMRT ali HUDE TELESNE POŠKODBE.

Никога не устанављивајте обраћеном назад детског удрживајућег сиденје на преднем пассажирском сиденје при неотключеној подушке безопасности. Это может привести к смерти ребенка или к тяжелым повреждениям.

NIKDY nepoužívajte detskú sedačku smerujúcu dozadu na sedadle s AKTÍVNÝM čelným AIRBAGOM, mohlo by prísť k USMRTENIU alebo VÁŽNEMU ZRANENIU DIEŤAŤA.

NEIEVIETOJĪET ar skatu pretēji braukšanas virzienam vērstu bērnu sēdekļiti šajā sēdekļi, ja tā priekšā uzstādītais GAISA SPILVENS ir AKTIVIZĒTS, – tas BĒRNAM var radīt NOPIETNAS TRAUMAS vai pat izraisīt BĒRNA NĀVI.

ÄRGE kasutage seljaga sõidusuunas laste turvatooli istmel, mille ees on AKTIIVNE TURVAPADI. LAPS võib saada TÕSISE KEHAVIGASTUSE või HUKKUDA.

NIEKADA nevežkite vaiku prie automobili sēdynēs atvirkščiāi jūdējimo krypčiāi pritvirtintojē specialiojē kēdūtējē, jeigu šī sēdynē apsaugota VEIKIANČIA SAUGOS PAGALVE, nes VAIKUI kyļa MIRTINAS ar SUNKAUS SUŽEIDIMO pavojus.

Ніколи не встановлюйте дитяче крісло спинкою вперед на сидінні, передня ПОДУШКА БЕЗПЕКИ якого не заблокована. Ризик ЗАГИБЕЛІ або ТЯЖКИХ ТРАВМ дитини.

„Никога на използвайте детско столче за автомобил, монтирано с гръб към движението, на седалка оборудвана с предпазна въздушна възглавница пред нея. Съществува риск за живота или сериозно нараняване на детето!“

يُحذر نهائيًا تثبيت مقعد الطفل بشكل عكسي على القعد المحمي بوسادة هوائية نشطة أمام مقعد الطفل، فمن الممكن أن يتسبب ذلك في وفاة الطفل أو إصابته بجروح خطيرة

NUNCA utilize uma cadeirinha protetora para crianças voltada para a traseira em um assento que seja protegido por um AIRBAG ATIVO na frente do assento. Podem ocorrer MORTE ou FERIMENTOS GRAVES para a CRIANÇA.

هرگز از کمر بند کودک رو به پشت در روبروی صندلی حفاظت شده توسط ACTIVE AIRBAG (کیسه هوای فعال) استفاده نکنید. این کار ممکن است باعث مرگ یا جراحت شدید در کودک شود.

절대로 능동형 에어백이 전면에 설치된 좌석에 후향식 어린이 보호시트를 사용하지 마십시오. 어린이에게 심각한 상해를 입히거나 사망에 이르게 할 수 있습니다.

前部に作動可能なエアバッグが装着されているシートに、後ろ向きのチャイルドシートを絶対に使用しないでください。お子様に死や大けがを招く恐れがあります。

禁止在座椅前部安全气囊激活的情况下，在该座椅上使用后向儿童安全座椅，可能造成儿童严重受伤甚至死亡。

QUICK REFERENCE

- In case of emergency ... 6-2
(Flat tyre, engine will not start, overheating, towing)
- How to start the engine ... 5-15
- How to read the meters and gauges ... 2-2
- Maintenance and do-it-yourself ... 8-2
- Technical information ... 9-2

امداد خودرو فارما

تلفن شبانه روزی: ۰۲۱-۸۸۸۶۲۰۸۵

FarmaSOS.com

SECURITY INFORMATION

As owner of this vehicle important codes have been supplied to you that may be required by your NISSAN dealer to duplicate keys or repair the radio.

Please fill in the allocated areas or attach sticker(s) if available. Remove this page and keep it in a safe place, **not in the vehicle**.

When selling your vehicle, we kindly request you to hand over this page to the buyer.

SECURITY INFORMATION

Radio security code
(where fitted)

--	--	--	--

Key number

--	--	--	--	--	--

Wheel lock key code
(where fitted)

--	--	--	--	--	--	--	--

Remove this page from the manual and keep it in a safe place, **not in the vehicle**.

When selling your vehicle, we kindly request you to hand over this page to the buyer.



امداد خودرو فارما

تلفن شبانه روزی: ۰۲۱-۸۸۸۶۲۰۸۵

FarmaSOS.com